

# Textiles in automotive engineering

---

Walter Fung and Mike Hardcastle



The Textile Institute



WOODHEAD PUBLISHING LIMITED

Cambridge England

Published by Woodhead Publishing Limited in association with The Textile Institute  
Abington Hall, Abington  
Cambridge CB1 6AH, England  
www.woodhead-publishing.com

Published in North and South America by  
Technomic Publishing Company Inc  
851 New Holland Avenue, Box 3535  
Lancaster, Pennsylvania 17604 USA

First published 2001, Woodhead Publishing Ltd and Technomic Publishing  
Company Inc

© 2001, Woodhead Publishing Ltd

The authors have asserted their moral rights.

This book contains information obtained from authentic and highly regarded sources. Reprinted material is quoted with permission, and sources are indicated. Reasonable efforts have been made to publish reliable data and information, but the authors and the publishers cannot assume responsibility for the validity of all materials. Neither the authors nor the publishers, nor anyone else associated with this publication, shall be liable for any loss, damage or liability directly or indirectly caused or alleged to be caused by this book.

Neither this book nor any part may be reproduced or transmitted in any form or by any means, electronic or mechanical, including photocopying, microfilming and recording, or by any information storage or retrieval system, without permission in writing from the publishers.

The consent of Woodhead Publishing Ltd and Technomic Publishing Company Inc does not extend to copying for general distribution, for promotion, for creating new works, or for resale. Specific permission must be obtained in writing from Woodhead Publishing Ltd or Technomic Publishing Company Inc for such copying.

Trademark notice: Product or corporate names may be trademarks or registered trademarks, and are used only for identification and explanation, without intent to infringe.

British Library Cataloguing in Publication Data

A catalogue record for this book is available from the British Library.

Library of Congress Cataloging in Publication Data

A catalog record for this book is available from the Library of Congress.

Woodhead Publishing ISBN 1 85573 493 1

Technomic Publishing Company ISBN 1-58716-080-3

Cover design by The ColourStudio

Typeset by Best-set Typesetter Ltd, Hong Kong

Printed by T J International, Cornwall, England

Dedicated to my forebears, Taishan County, Guangdong Province, China  
*Walter Fung*  
*(Feng Qing Xiang)*

To Christine my wife whose unflappable character, cheerful disposition, patience and constant support have provided the inspiration for my contribution to this publication and many other enterprises.

*Mike Hardcastle*

In preparing this textbook, it has been the authors' objective to provide a work of reference and instruction to all those involved with textiles in the automotive industry. Textiles are present in many forms in the automobile ranging from the seats to battery separators, from headliners to bonnet liners. The automotive textile industry requires knowledge of several disciplines, textile chemistry, fabric technology, plastics' science, production engineering and interior fabric design. The latter, which has become more important in recent years, combines artistic talent with textile technology. Some information is available in specialist trade journals but there is shortage of literature and especially textbooks dealing with the subject as a whole. This book is intended to plug that gap and cuts across all the disciplines involved.

The book is written in a concise, simple style which it is hoped can be understood by anyone with only a basic scientific background knowledge. The scientific principles are explained to help readers understand why processes are done in such a way, and it is also hoped this will assist with problem solving. Because of the practical nature of the industry, all technical, design and manufacturing personnel are frequently referred to as 'engineers'. It is hoped that this book, while containing some scientific theory and some history to make it more readable, will be of practical help to all automobile engineers who deal with components containing a textile and also to interior trim designers.

Today the technical requirements of performance and durability of interior trim fabrics, often seem to override all other considerations such as colour design and texture. However it must not be forgotten that the original driving force for the widespread use of textile fabrics and structures in car interiors during the early 1970s was to expand the design and colour potential of the car interior, which aesthetically had become fairly dull and uninspiring. An attractive interior trim is now regarded as a major aid to sales and model differentiation. The different textile production methods of weaving, knitting and printing all come with their own particular advan-

tages and features, but also with limitations regarding the design and colouration achievable. The importance of all of these aspects, which concern both the fabric supplier and the car manufacturer, is fully explored in this book.

In the face of very severe competition, the automotive industry worldwide is undergoing intensive and wide-ranging restructuring. At present cost is the major driving force in development as a whole. New processes are being introduced to make components more quickly and more economically. Frequently they involve processes and conditions, usually applied to more heat-resistant plastics, which are adapted to process textiles which are less heat resistant and have delicate surfaces and texture. Examples are the newer moulding processes now being used for door casings, seats, and other interior trim. Sometimes the operatives and even supervisors involved have no comprehension of what conditions the textile will withstand in terms of temperature and pressure. The result is many rejects which can be detrimental to the factory involved and to the industry as a whole. This book should help by explaining the physical limitations and other properties of the textile.

Car makers, known as Original Equipment Manufacturers (OEMs) are becoming assemblers of outsourced components or modules made by their direct suppliers, the so called Tier-1 companies. When Henry Ford invented the production line his warehouse always carried 4 months of spares so that the production line never stopped. Today, the efficient OEM has virtually no warehouse but relies on just-in-time (JIT) deliveries of components. This necessitates the Tier-1 suppliers' production to be always right up to schedule. In turn the production schedules of the suppliers to the Tier-1s must also be on time. Severe financial penalties may be imposed by the OEMs, if production lines are held up. This situation demands that any production problem must be quickly identified and put right.

Frequently the past history of the textile has contributed to a particular fault and it is very important that the quality engineer is familiar with the previous process, which the textile has already undergone, to solve that problem – and better still to prevent it happening again. In addition, the quality engineer should be fully aware of the process conditions his own customer will subject the material to, so that he can be sure that his own process is not likely to cause problems further down the production chain or for the ultimate customer, the car purchaser. This book should be invaluable to the quality engineer in these activities to improve quality and efficiency and hence profitability.

The book should also be of use in universities and colleges for both students and research workers, who now have all the relevant information in one textbook, together with numerous literature references, refer-

ences to test methods and a glossary of unfamiliar terms and abbreviations. A detailed list of technical and professional organizations, journals and recommended conferences are also presented for keeping up to date.

## Acknowledgements

---

The authors thank the Directors of Collins and Aikman Automotive Fabrics Ltd for permission to write this book. Thanks are also due to the following who have helped by checking parts of the manuscript for accuracy, by supplying information or have helped in some other way; Peter Adshead, Martin Barrick, Peter Booth, John Briggs and Melanie Wray, (Collins and Aikman Automotive Fabrics Ltd), Cliff Kemp (Collins and Aikman Carpet Division), Nick McMichael (Collins and Aikman Acoustic Division), Barrie Crabtree (Cosmopolitan Textiles), Keith Barlow (Selectus), Bill Whitehouse (Acordis), Ian Charnock (Toray Textiles Europe), Geoff Formoy (Cornelius Chemical Co), Chris Hinchcliff (Courtaulds Textiles), Dr Kevin Niderost (Kumho Europe), Dr John Barnes (DuPont Europe), Dr Harry Fung (EA Technology), Jeff Caunt (Karl Meyer Textile Machinery Ltd), Michael Clay (Allertex Ltd Bradford), Michael Dicks (Shima Seiki Europe Ltd), Jim Freeman (Jeftex Ltd), Irene Haasis (Mayer & Cie GmbH & Co), Malcolm Howard and Simon Maynard (Robert S Maynard Ltd), Ralph Moakes (Vernon Cooper Ltd), Gilbert Moulin (Michel Van de Wiele), Stewart Partridge (Web Consulting Ltd), Matthew Robinson (Rieter-Scragg Ltd), Duncan Sephton (Standfast Dyers and Printers Ltd), Dave Walton, (Freudenberg), Richard Bates (Crompton & Knowles), Dr Darren McMurray (Phoenix Fire Inhibitors), John Retford (Lantor), Walter Duncan (Synthomer), David Dykes (British Vita), Gerald Day (formerly Delphi), Simon Beeley (John Holdsworth and Company), Ian Leigh (BF Goodrich), Simon Fung (ADtranz, DaimlerChrysler Rail Systems), Guy Badham (Rolls Royce plc), John de Main (Velcro Europe), Brian McDonagh (Hope Industrie), Helmut Schierbaum (Bayer), David Wallwork and Keith Parton (Clariant), Alastair Hendry (Virgin Airlines), Geoff Holmes and Peter Tyers (Bostik), Alan Cross (BASF), Marcel Mallens (Griltex-EMS), Andrew Christie (3M Germany), Francis Woodruff (Web Processing), Tom Govier (Shirley Developments Ltd), Jim McCullough (Barbour Campbell Threads Ltd), Dr Ranber Mann (BFF Nonwovens), Mike Appleton (Sybron/Tanatex), Alan Wootten (formerley Alplas),

Sheila Morris and John McGarrie (Ciba), Jason Payne (3M Automotive Systems) and Juli Case and staff at IFAI Technical Services.

Thanks also to the following for supplying illustrations and permission to reproduce material; Reeves Brothers, Inc. USA; Beaufort Air-Sea Equipment Ltd. (Wardle Storeys); EDANA, Brussels; DH Leather, Textile Machinery Ilkley; Paul KIEFEL GmbH, Frielassing; DuPont International SA Geneva; Herbert Meyer GmbH; Thies (UK) Ltd; Ozark Systems; Roaches International; SAE International, Warrendale PA USA; British Rubber Manufacturers Association Ltd; Freudenberg Vliesstoffe KG; Chris Chiles, (Nordson); Ulli Sellen (Alplas/Atlas); Phil Hextall (Border Textiles/Obem); Siubhan Reid-Litherland (LMC Automotive Services), Nick Butler (Technical Textiles International); Robert Jackson Wardle/Werner Mathis AG and 3M Deutschland GmbH.

# Textiles in automotive engineering

---

Walter Fung and Mike Hardcastle



The Textile Institute



WOODHEAD PUBLISHING LIMITED

Cambridge England

Published by Woodhead Publishing Limited in association with The Textile Institute  
Abington Hall, Abington  
Cambridge CB1 6AH, England  
www.woodhead-publishing.com

Published in North and South America by  
Technomic Publishing Company Inc  
851 New Holland Avenue, Box 3535  
Lancaster, Pennsylvania 17604 USA

First published 2001, Woodhead Publishing Ltd and Technomic Publishing  
Company Inc

© 2001, Woodhead Publishing Ltd

The authors have asserted their moral rights.

This book contains information obtained from authentic and highly regarded sources. Reprinted material is quoted with permission, and sources are indicated. Reasonable efforts have been made to publish reliable data and information, but the authors and the publishers cannot assume responsibility for the validity of all materials. Neither the authors nor the publishers, nor anyone else associated with this publication, shall be liable for any loss, damage or liability directly or indirectly caused or alleged to be caused by this book.

Neither this book nor any part may be reproduced or transmitted in any form or by any means, electronic or mechanical, including photocopying, microfilming and recording, or by any information storage or retrieval system, without permission in writing from the publishers.

The consent of Woodhead Publishing Ltd and Technomic Publishing Company Inc does not extend to copying for general distribution, for promotion, for creating new works, or for resale. Specific permission must be obtained in writing from Woodhead Publishing Ltd or Technomic Publishing Company Inc for such copying.

Trademark notice: Product or corporate names may be trademarks or registered trademarks, and are used only for identification and explanation, without intent to infringe.

British Library Cataloguing in Publication Data

A catalogue record for this book is available from the British Library.

Library of Congress Cataloging in Publication Data

A catalog record for this book is available from the Library of Congress.

Woodhead Publishing ISBN 1 85573 493 1

Technomic Publishing Company ISBN 1-58716-080-3

Cover design by The ColourStudio

Typeset by Best-set Typesetter Ltd, Hong Kong

Printed by T J International, Cornwall, England

Dedicated to my forebears, Taishan County, Guangdong Province, China  
*Walter Fung*  
*(Feng Qing Xiang)*

To Christine my wife whose unflappable character, cheerful disposition, patience and constant support have provided the inspiration for my contribution to this publication and many other enterprises.

*Mike Hardcastle*

In preparing this textbook, it has been the authors' objective to provide a work of reference and instruction to all those involved with textiles in the automotive industry. Textiles are present in many forms in the automobile ranging from the seats to battery separators, from headliners to bonnet liners. The automotive textile industry requires knowledge of several disciplines, textile chemistry, fabric technology, plastics' science, production engineering and interior fabric design. The latter, which has become more important in recent years, combines artistic talent with textile technology. Some information is available in specialist trade journals but there is shortage of literature and especially textbooks dealing with the subject as a whole. This book is intended to plug that gap and cuts across all the disciplines involved.

The book is written in a concise, simple style which it is hoped can be understood by anyone with only a basic scientific background knowledge. The scientific principles are explained to help readers understand why processes are done in such a way, and it is also hoped this will assist with problem solving. Because of the practical nature of the industry, all technical, design and manufacturing personnel are frequently referred to as 'engineers'. It is hoped that this book, while containing some scientific theory and some history to make it more readable, will be of practical help to all automobile engineers who deal with components containing a textile and also to interior trim designers.

Today the technical requirements of performance and durability of interior trim fabrics, often seem to override all other considerations such as colour design and texture. However it must not be forgotten that the original driving force for the widespread use of textile fabrics and structures in car interiors during the early 1970s was to expand the design and colour potential of the car interior, which aesthetically had become fairly dull and uninspiring. An attractive interior trim is now regarded as a major aid to sales and model differentiation. The different textile production methods of weaving, knitting and printing all come with their own particular advan-

tages and features, but also with limitations regarding the design and colouration achievable. The importance of all of these aspects, which concern both the fabric supplier and the car manufacturer, is fully explored in this book.

In the face of very severe competition, the automotive industry worldwide is undergoing intensive and wide-ranging restructuring. At present cost is the major driving force in development as a whole. New processes are being introduced to make components more quickly and more economically. Frequently they involve processes and conditions, usually applied to more heat-resistant plastics, which are adapted to process textiles which are less heat resistant and have delicate surfaces and texture. Examples are the newer moulding processes now being used for door casings, seats, and other interior trim. Sometimes the operatives and even supervisors involved have no comprehension of what conditions the textile will withstand in terms of temperature and pressure. The result is many rejects which can be detrimental to the factory involved and to the industry as a whole. This book should help by explaining the physical limitations and other properties of the textile.

Car makers, known as Original Equipment Manufacturers (OEMs) are becoming assemblers of outsourced components or modules made by their direct suppliers, the so called Tier-1 companies. When Henry Ford invented the production line his warehouse always carried 4 months of spares so that the production line never stopped. Today, the efficient OEM has virtually no warehouse but relies on just-in-time (JIT) deliveries of components. This necessitates the Tier-1 suppliers' production to be always right up to schedule. In turn the production schedules of the suppliers to the Tier-1s must also be on time. Severe financial penalties may be imposed by the OEMs, if production lines are held up. This situation demands that any production problem must be quickly identified and put right.

Frequently the past history of the textile has contributed to a particular fault and it is very important that the quality engineer is familiar with the previous process, which the textile has already undergone, to solve that problem – and better still to prevent it happening again. In addition, the quality engineer should be fully aware of the process conditions his own customer will subject the material to, so that he can be sure that his own process is not likely to cause problems further down the production chain or for the ultimate customer, the car purchaser. This book should be invaluable to the quality engineer in these activities to improve quality and efficiency and hence profitability.

The book should also be of use in universities and colleges for both students and research workers, who now have all the relevant information in one textbook, together with numerous literature references, refer-

ences to test methods and a glossary of unfamiliar terms and abbreviations. A detailed list of technical and professional organizations, journals and recommended conferences are also presented for keeping up to date.

## Acknowledgements

---

The authors thank the Directors of Collins and Aikman Automotive Fabrics Ltd for permission to write this book. Thanks are also due to the following who have helped by checking parts of the manuscript for accuracy, by supplying information or have helped in some other way; Peter Adshead, Martin Barrick, Peter Booth, John Briggs and Melanie Wray, (Collins and Aikman Automotive Fabrics Ltd), Cliff Kemp (Collins and Aikman Carpet Division), Nick McMichael (Collins and Aikman Acoustic Division), Barrie Crabtree (Cosmopolitan Textiles), Keith Barlow (Selectus), Bill Whitehouse (Acordis), Ian Charnock (Toray Textiles Europe), Geoff Formoy (Cornelius Chemical Co), Chris Hinchcliff (Courtaulds Textiles), Dr Kevin Niderost (Kumho Europe), Dr John Barnes (DuPont Europe), Dr Harry Fung (EA Technology), Jeff Caunt (Karl Meyer Textile Machinery Ltd), Michael Clay (Allertex Ltd Bradford), Michael Dicks (Shima Seiki Europe Ltd), Jim Freeman (Jeftex Ltd), Irene Haasis (Mayer & Cie GmbH & Co), Malcolm Howard and Simon Maynard (Robert S Maynard Ltd), Ralph Moakes (Vernon Cooper Ltd), Gilbert Moulin (Michel Van de Wiele), Stewart Partridge (Web Consulting Ltd), Matthew Robinson (Rieter-Scragg Ltd), Duncan Sephton (Standfast Dyers and Printers Ltd), Dave Walton, (Freudenberg), Richard Bates (Crompton & Knowles), Dr Darren McMurray (Phoenix Fire Inhibitors), John Retford (Lantor), Walter Duncan (Synthomer), David Dykes (British Vita), Gerald Day (formerly Delphi), Simon Beeley (John Holdsworth and Company), Ian Leigh (BF Goodrich), Simon Fung (ADtranz, DaimlerChrysler Rail Systems), Guy Badham (Rolls Royce plc), John de Main (Velcro Europe), Brian McDonagh (Hope Industrie), Helmut Schierbaum (Bayer), David Wallwork and Keith Parton (Clariant), Alastair Hendry (Virgin Airlines), Geoff Holmes and Peter Tyers (Bostik), Alan Cross (BASF), Marcel Mallens (Griltex-EMS), Andrew Christie (3M Germany), Francis Woodruff (Web Processing), Tom Govier (Shirley Developments Ltd), Jim McCullough (Barbour Campbell Threads Ltd), Dr Ranber Mann (BFF Nonwovens), Mike Appleton (Sybron/Tanatex), Alan Wootten (formerley Alplas),

Sheila Morris and John McGarrie (Ciba), Jason Payne (3M Automotive Systems) and Juli Case and staff at IFAI Technical Services.

Thanks also to the following for supplying illustrations and permission to reproduce material; Reeves Brothers, Inc. USA; Beaufort Air-Sea Equipment Ltd. (Wardle Storeys); EDANA, Brussels; DH Leather, Textile Machinery Ilkley; Paul KIEFEL GmbH, Frielassing; DuPont International SA Geneva; Herbert Meyer GmbH; Thies (UK) Ltd; Ozark Systems; Roaches International; SAE International, Warrendale PA USA; British Rubber Manufacturers Association Ltd; Freudenberg Vliesstoffe KG; Chris Chiles, (Nordson); Ulli Sellen (Alplas/Atlas); Phil Hextall (Border Textiles/Obem); Siubhan Reid-Litherland (LMC Automotive Services), Nick Butler (Technical Textiles International); Robert Jackson Wardle/Werner Mathis AG and 3M Deutschland GmbH.

# Contents

---

	<i>Preface</i>	x
	<i>Acknowledgements</i>	xiii
<b>1</b>	<b>Introductory survey</b>	<b>1</b>
1.1	General survey	1
1.2	Material survey – fibres	8
1.3	Material survey – plastics	15
1.4	Material survey – natural and synthetic rubbers	18
1.5	Requirements from suppliers	19
1.6	References	22
1.7	Further reading	22
<b>2</b>	<b>Interior design</b>	<b>24</b>
2.1	Interior design	24
2.2	Further reading	42
<b>3</b>	<b>Fabric structures and production methods</b>	<b>44</b>
3.1	Introduction, fibres and yarn types	44
3.2	Fabric structures – wovens	54
3.3	Fabric structures – warp knitted	76
3.4	Fabric structures – weft knitted	86
3.5	Fabric structures – flat-bed knitting	94
3.6	Fabric structures – non-wovens	95
3.7	References	106
3.8	Further reading	106
<b>4</b>	<b>Yarn and fabric processing</b>	<b>110</b>
4.1	Introduction	110
4.2	Dyeing and finishing	112
4.3	Printing	126

viii	Contents	
4.4	Coating and lamination	137
4.5	References	155
4.6	Further reading	156
<b>5</b>	<b>Quality assurance and testing</b>	<b>158</b>
5.1	Quality assurance	158
5.2	Test method details	166
5.3	References	190
5.4	Further reading	192
<b>6</b>	<b>Product engineering – interior trim</b>	<b>194</b>
6.1	Introduction	194
6.2	Seats	195
6.3	Headliners	212
6.4	Door casings	215
6.5	Parcel shelves	218
6.6	Other interior trim	219
6.7	Complete modular interiors	221
6.8	References	222
6.9	Further reading	226
<b>7</b>	<b>Other textile applications</b>	<b>227</b>
7.1	Introduction	227
7.2	Seat belts	228
7.3	Airbags	231
7.4	Carpets	234
7.5	Cabin air filters	238
7.6	Battery separators	241
7.7	Bonnet (hood) liners	242
7.8	Wheel arch liners	243
7.9	Hood material for convertibles	243
7.10	Tyres	244
7.11	Hoses and belts – general considerations	247
7.12	References	249
7.13	Further reading	252
<b>8</b>	<b>Automotive textiles and the environment</b>	<b>254</b>
8.1	Introduction	254
8.2	The greenhouse effect and global warming	255
8.3	Environmental legislation	257
8.4	The effects of pollutants	263

8.5	Manufacturing concerns	265
8.6	Sustainable development	269
8.7	References	275
8.8	Further reading	279
<b>9</b>	<b>Textiles in other forms of transportation</b>	<b>281</b>
9.1	Introduction	281
9.2	Composite materials	282
9.3	Flame retardancy	289
9.4	Fabric coating	292
9.5	Textiles in other road vehicles	302
9.6	Railway applications	306
9.7	Marine applications	308
9.8	Textiles in aircraft	311
9.9	References	319
9.10	Further reading	322
<b>10</b>	<b>Future development and outlook</b>	<b>324</b>
10.1	General survey	324
10.2	Manufacturing	326
10.3	Fabric performance	327
10.4	New developments and opportunities	328
10.5	Environmental issues	329
10.6	Visions of the future – fabric design aspects	331
10.7	Further visions of the future	332
10.8	References	334
10.9	Further reading	334
<b>11</b>	<b>Sources of further information</b>	<b>336</b>
11.1	Conferences	337
11.2	Journals	339
11.3	Technical and professional organizations and institutions	343
11.4	Market information on automotive industry	347
11.5	General textile reference	348
11.6	Glossary of terms and abbreviations	348
11.7	Abbreviations used in references at end of chapters	354
	<i>Index</i>	355

## 1.1 General survey

The automobile industry is the largest user of technical textiles, with about 20kg in each of the 45 million or so cars made every year world-wide (see Tables 1.1 and 1.2). Despite production overcapacity, and near market saturation in the developed world of Western Europe, the USA and Japan, car production is set to increase for the foreseeable future especially in the developing countries of the world. Significant new markets are opening up in Eastern Europe, South America and the Pacific Rim countries. Total world car production growth has been generally static in the years 1997 to 1999, but by 2004 analysts predict a growth of about 12% on 1999 figures.

Mobility is a fundamental requirement of all human activity whether it falls into either of the two categories of work or play. Cars embody personal freedom and for some an expression of individuality. Despite environmental issues, more and more crowded roads and ever increasing costs of motoring, people are not going to give up their cars. Statistics released by the US Department of Transportation in early 1998 revealed that motor vehicles were the preferred form of travel in long distance trips up to 2000 miles and 80% of all journeys of 100 miles or more were taken in motor vehicles, i.e. cars, trucks or vans.

Of special relevance to textile manufacturers, car interiors have become more important within recent years for a variety of reasons. People are spending more time in their cars, commuting longer distances to work on a daily or weekly basis. They have more leisure time and higher disposable incomes for more days out to visit places of interest, friends and relations as well as trips to the supermarket and out-of-town shopping centres. For business people the car is a place of work, being able to communicate with colleagues and customers by mobile telephone. The car in fact has become an office, a living room and a shopping bag on wheels! From the point of view of the original equipment manufacturers (OEMs), changing the car interior design of an existing model is an economical way to revamp a

Table 1.1 World personal vehicle sales ('000 units)

	1996	1997	1998	1999	2000	2001	2002	2003	2004
North America									
USA: Car	8 527	8 272	8 160	7 992	7 547	7 360	7 596	7 810	8 057
USA: LT	5 709	5 985	6 498	6 674	6 144	6 234	6 534	6 709	6 867
Canada: Car	661	739	746	755	720	657	665	703	725
Canada: LT	428	550	565	580	565	511	519	573	574
Mexico: Car	179	303	430	428	469	486	469	443	447
Mexico: LT	99	137	163	165	181	184	185	210	215
Total	15 602	15 987	16 561	16 593	15 626	15 433	15 969	16 448	16 885
Latin America	1 679	1 864	1 502	1 295	1 504	1 671	1 784	1 886	1 984
Western Europe	12 859	13 459	14 431	14 524	14 508	14 873	15 029	14 681	14 271
Germany	3 496	3 528	3 736	3 841	3 869	3 929	3 977	3 925	3 794
Italy	1 725	2 396	2 369	2 086	2 017	2 215	2 241	2 104	2 041
France	2 132	1 713	1 944	2 055	2 125	2 207	2 236	2 187	2 108
UK	2 025	2 171	2 247	2 119	2 065	2 100	2 143	2 098	2 136
Spain	963	1 069	1 262	1 376	1 419	1 399	1 387	1 374	1 298
Eastern Europe	1 878	2 300	2 253	2 117	2 285	2 527	2 735	3 006	3 204
Japan	4 669	4 492	4 094	4 155	4 332	4 691	4 899	5 170	5 342
Asia/Pacific	3 088	3 082	2 172	2 448	2 836	3 171	3 452	3 740	4 041
Other	3 893	4 062	4 184	4 409	4 866	5 158	5 220	5 328	5 354
World	43 668	45 246	45 198	45 542	45 957	47 523	49 089	50 260	51 081

Source: SMMT, National Sources, J.D. Power-LMC.

Note: The total for sales in 'Other' countries also includes a statistical balancing item to compensate for inconsistencies and inadequancies in national data, and equate world sales to world production.

LT, Refers to light trucks used as personal transport vehicles in North America.

Reproduced with kind permission of LMC Automotive Services (Oxford) UK.

Table 1.2 World light commercial vehicle sales ('000 units)

	1996	1997	1998	1999	2000	2001	2002	2003	2004
North America									
USA	862	857	904	911	807	821	866	889	910
Canada	83	100	102	104	98	86	85	93	93
Mexico	14	22	28	28	29	29	29	33	34
Total	958	979	1034	1043	934	936	981	1015	1037
Latin America	316	359	328	301	322	382	432	446	471
Western Europe	1317	1426	1605	1634	1634	1646	1650	1625	1603
Germany	174	188	214	207	206	222	216	214	193
Italy	144	141	172	167	156	150	150	145	140
France	331	312	347	366	389	396	390	367	359
UK	207	228	241	221	203	198	204	204	205
Spain	129	160	183	198	214	222	230	239	241
Eastern Europe	292	359	366	346	399	484	572	635	669
Japan	2334	2189	1720	1636	1746	1846	1963	1942	1957
Asia/Pacific	2129	1938	1485	1601	1782	2006	2209	2363	2482
Other	353	369	371	365	405	440	464	477	487
World	7699	7619	6910	6926	7223	7740	8271	8502	8707

Source: SMMT, National Sources, J.D. Power-LMC.

Light commercial vehicles are those of less than 6-t GVW, and figures for countries outside North America include vehicles which would be classified in North America as 'light trucks'.

Reproduced with kind permission of LMC Automotive Services (Oxford) UK.

model that is not selling well. Consumer researchers in the USA believe that the car interior will become a focal point for brand recognition.<sup>1</sup> Textile design and colour will inevitably be an essential tool in creating these distinctive interiors.

Textiles provide a means of decoration and a warm soft touch to the seats and the interior of the car, but they are also used in more functional applications. Carpets and textile headliners not only contribute to the overall comfort and decor of the interior, but they also play an important part in damping of sound and vibration. The use of textiles in tyres contributes to the performance, road handling and tyre durability. Reinforcing textile yarns are essential for high-pressure hoses and belts. Non-woven fabrics are used extensively in air and oil filters, bonnet liners and as production aids during manufacture. Fibre composites in place of heavier metal components are helping to reduce the weight of the car, and in many cases simplifying production methods together with other advantages. Seat belts, airbags and associated safety devices are contributing to road safety and saving lives. In addition to the major components there are numerous other textile items such as sewing threads, fastening devices, tie cords, flocked fabric on window seals and even in the battery as electrode separators. Many of these appli-

cations have only become possible within the last two or three decades as newer high-performance materials such as aramids became available. Specialist variants of aramids and other fibres have been developed for particular applications and this process is continuing.

The 20 kg of textiles in an average car is made up approximately from 3.5 kg seat covers, 4.5 kg carpets, 6.0 kg other parts of the interior and tyres and 6.0 kg glass fibre composites.<sup>2</sup> This is possibly conservative when absolutely all textile-containing items are included, and is likely to increase further when at least one airbag, and in the future possibly as many as four or more airbags or related safety devices, are installed as standard items. The weight of fibre in composites could also increase to replace heavier metal in the quest to make cars lighter and more efficient. In addition, in the effort to improve recycling of car interior components some polyurethane foam could be replaced with polyester, or some other fibre. This fibre itself could be a recycled material and this has already happened in some current production cars. In recent years there has been a revival of interest in natural fibre such as jute, sisal and kapok for use in automobiles, especially in composites.

### 1.1.1 The beginning

The motor industry has come a long way since Karl Benz of Mannheim in Germany built the first successful petrol-engined car in 1885, which some regard as the beginning of the commercial motor industry.<sup>3,4</sup> This vehicle was in fact a three-wheeler, the first successful four-wheeled, petrol-engined car was produced by Gottlieb Daimler in 1886. Apparently the two founding fathers never met and did their work independently of each other. The closing years of the nineteenth century was an exciting period of new developments, and by the turn of the century there was an embryonic motor industry in the USA as well as Europe. The first successful American car was produced in 1893. In Britain the 'red flag' law, which required a man walking in front of cars carrying a red flag, hindered progress. This law was not fully repealed until 1896, after which date a vast number of companies seeing the potential in this new transportation industry began to build cars, many with engines imported from the continent. There were about 32 car manufacturers in Coventry alone at the beginning of the twentieth century, among them was Rover which began production in 1904. The General Motors Company (which became General Motors Corporation), was founded in September 1908 and within about a year included, the Buick, Olds(mobile), Cadillac and Oakland (later Pontiac) companies.

The first reliable world figures show that France led the world in 1903, making half of the world's total output of about 62 000 vehicles, with the

USA making about 11 000 vehicles in second place.<sup>3</sup> Apparently, restrictive traffic regulations in Germany checked the growth of the industry in the country which had been the pioneer. However, the motor industry did not really take off until Henry Ford introduced mass-production-line assembly in 1908 at Detroit, and in 1913 at Old Trafford, Manchester, to make his Model T Ford. Until this time car parts were in general, made individually by hand with skilled labour. Ford invested in large machine tools that could stamp out parts by the thousand all exactly the same without the need for skilled operatives. However, these new tools were extremely expensive and so very large numbers of cars needed to be built and sold to recoup the cost. Other car makers soon copied Ford's system and the modern motor industry was born.<sup>4,5</sup>

### 1.1.2 The new beginning

The Toyoda family founded the Toyota Motor Company in 1937 but it was not until the 1950s that they and other Japanese companies developed their 'lean production' methods, which were later to be adopted throughout the world. This development was the start of another significant landmark in the international automotive industry – competition from Japanese car manufacturers. The Japanese brought new methods and cultures to the mass production of motor cars and their appearance on the international scene in the 1960s significantly intensified worldwide competition.

### 1.1.3 The present day

Today the same principles apply; the cost of development of a new model and making tools for mass production are so expensive that cars must sell in large numbers quickly against the international competition, first to recover the development costs, and then to make a profit. However, today the numbers required are so large that cars, especially those made in Europe must sell in more than one country to make a profit. The automotive industry has become a global industry and car makers must manufacture on a global scale to compete. The concept of the 'global car', a single model which could sell all over the world has been the subject of discussion, including discussion on the actual definition of the term. It would allow production on an enormous scale with all the benefits of very long production runs and reduced unit development costs. However, it is likely to need regional or national features, especially in the interior trim and some writers believe a 'global car', in the strict definition of the term is not possible. A more practical approach is rationalising and limiting the number of 'platforms' – the basic engineering structure of the car – and most OEMs are doing this. For example, Volkswagen currently build 33 car models on

11 platforms but by the year 2005 are expected to be building 55 models on only four platforms.<sup>6</sup>

Competition between individual OEMs has become extremely intense and is intensifying further as they strive to increase their share of the market by producing cars with better value for money and with more marketable designs both exterior and interior. At the same time production costs are being continually reduced. Development of new models, designs and more economical production methods and materials have become essential. Development times-to-market are becoming shorter and shorter, to respond more quickly to market demands. A three-year minimum was once the norm but some OEMs claim they can reduce this, in some cases, to less than one year.

Although large-scale production is essential for economy, the customer is demanding more choice, both in actual appearance and interior design of the vehicle as well as accessories and more practical features. In fact different classes of vehicle have appeared to satisfy different customer life styles and individual requirements. Specialist vehicles described by the new terminology such as 'recreational vehicle' (RV), 'sports utility vehicle' (SUV) or 'multi-purpose vehicle' (MPV) have appeared. In the USA pick-up trucks now sell in numbers that are comparable with saloon cars (see Table 1.1). To compete effectively each OEM must be represented in each of these categories and each category may have its own variants. OEMs are striving to reduce costs by economies of scale of production and at the same time cater for a wide diversity of individual customer requirements.

In the effort to reduce production costs OEMs have become assemblers of components produced outside their own factory by specialist suppliers who also make the same components, e.g. seats for other OEMs. These direct, 'Tier-1 suppliers' cut production costs by making the components in very large volume, by bulk-buying of components and raw materials – anywhere in the world and by combining small individual items together into larger single modules that can be installed quickly into the car on the production line. This system of 'outsourcing' is now a standard feature of the automobile and other industries, and is being developed further, involving even larger unit modules. An example of a large module is a modern headliner which can incorporate a number of items such as a sun-roof, light units and assist handles.

An important feature of modern 'lean' production is just-in-time (JIT) delivery. With JIT delivery, ideally, no warehouse is necessary, which simplifies stock control, administration and helps cash flow. The Tier-1 suppliers have also become global manufacturers, and need to be close geographically to the OEM plants they supply to facilitate JIT delivery. In turn, their suppliers, the Tier-2s also ideally, need to be close to their cus-

tomers. OEMs are continually applying pressure to cut costs, indeed one major OEM in 1995 announced their requirement of 3–6% annual cuts to the year 2000, i.e. 20% compounded from their Tier-1 suppliers.<sup>7</sup> The ‘cost down’ has become a regular feature of the auto industry. To achieve even further cost savings a process of consolidation is taking place among Tier-1s, Tier-2s and the OEMs themselves. The Lear Corporation is buying up interior component companies with the intention of eventually being able to offer entire car interiors to an OEM at an agreed price.<sup>8,9</sup> The trend is for OEMs, Tier-1s and others in the industry, to reduce the number of suppliers to simplify administration and reduce cost. In 1996 there were 400 Tier-1 suppliers, but by the year 2010 they are expected to number only 20, and some analysts believe there will be far fewer.<sup>10</sup> However OEMs expect more from the select few to supply JIT at the right price and right quality. Reliability and quality are so important that audition of suppliers is becoming standard practice in the industry. QS9000 quality standard, the requirement for suppliers to the American ‘Big Three’ of General Motors, Ford and Chrysler is becoming the requirement or basis of requirements for other OEMs. Long-term business relationships between suppliers and customers based on confidence and mutual understanding is now the preferred method of doing business, especially when a Japanese OEM is involved.

#### 1.1.4 New challenges

Probably the most important challenge that the motor industry faces today is the effect on the environment. More and more green countryside is being converted to traffic-choked roads, but more importantly, cars are burning up non-renewable fossil fuels, causing air pollution and global warming in the process. Attempts have been, and are being made, to make cars lighter so the engine has less work to do and thus save fuel. In addition, at the end of a car’s life the end-of-life vehicles (ELVs) are presenting problems in the disposal of the non-metallic parts, many of which at present go into landfill sites. Recycling of some materials is being done but there is still a long way to go. Attempts are being made to replace certain components such as polyurethane foam with polyester non-woven fibre (the seat cover is also polyester), to facilitate recycling by commonization of materials, i.e. using as few chemical types as possible. Solutions to environmental problems however usually increase cost, and government legislation, sometimes following action from environmental pressure groups, is often necessary to make things happen. EU Directives that are likely to change the way cars are made in the immediate future are imminent. These aspects are discussed in some detail in Chapter 8.

Similar to environmental issues, safety devices, such as seat belts and airbags, add to production costs and government action has been necessary

for widespread installation. As a result airbags and associated safety devices have become probably the largest single growth area in technical textiles at the present time. Half a million persons are killed on the roads worldwide every year and road accidents are becoming one of the top three causes for premature death. The governments of the world are applying pressure to reduce this by a number of methods, including making the car safer. Very recently, there has been a move to make cars less harmful to pedestrians in the event of an accident. Softer exterior front ends are being considered and possibly textiles may find a use here.

The car seat cover is perhaps the most familiar automotive textile to the layman, who may not appreciate the considerable technical input necessary, to develop a fabric which must stand up to rigorous use (and abuse), and still last the life of the car. In recent years the design and colour of the car interior, especially the seat have become extremely important in attracting the buyer's attention. During the mid-1990s a number of technical magazines appeared devoted entirely to automotive interiors, (see Chapter 11). The seat must be comfortable in all senses of the word both physically to the touch and also visually. Comfort has assumed more importance as people spend more time in cars for business, domestic, social and leisure activities. Comfort also helps prevent stress and fatigue and therefore contributes to road safety, and textiles have an important contribution to make in this area. This aspect is discussed in some detail in Chapter 6.

## **1.2 Material survey – fibres**

### **1.2.1 Early seat covers**

Many of the earliest cars were open top, and the first car seat covers were leather or leather imitations. Before the era of synthetic fibres, wool and cotton were used and when rayon and other man-made fibres became available, they were also used, sometimes in combinations to give coloured, toned effects. In the 1940s many car seats were covered in fabrics made from fibres spun from a copolymer of vinyl and vinylidene chloride (Saran in the USA, Velon or Tygan in the UK). This material was pigment dyed in the melt and had very high lightfastness and was also easy to clean. Also at this time just after World War II, nylon began to be used, sometimes in blends with other fibres such as cotton. A textiles encyclopaedia first written in the late 1950s, lists the main requirements of a car seat fabric in order of importance as; cleanability, durability, slideability, colour fastness and wrinkle-resistance.<sup>11</sup> The term slideability, refers to one notable disadvantage of the thick velours which were used in the earlier days, i.e. they were hard to clean and difficult to move about on. A notable absence from this list is ultra-violet (UV) light degradation resistance.

In the 1950s PVC-coated fabrics became widely used for apparel, domestic furniture and car seat covers. They were available in many attractive colours and could be embossed and ‘vinyl’ became much used as a fashion material. A further development produced ‘expanded vinyl’, which had a soft touch and closely resembled real leather. PVC car seat covers were very widely used in regular production cars until the early 1970s when rising living standards began to demand more comfort in cars. PVC seats were hot and sticky, especially in hot weather. Milliken and Fords themselves produced knitted PVC fabric made from threads obtained by slitting sheets of PVC film. This material was noticeably more breathable and comfortable than continuous PVC sheet.

Nylon, which was already being used in some car seats, began to be used more widely in different constructions and colours. However durability standards were rising as competition began to be more intense. Another factor, the 1973 Arab-Israeli war had a very significant effect on the industry at this time, causing the price of petrol to more than double almost overnight in the western world. The exterior styling of cars had already become important to attract customers but now, because of rising fuel costs, cars had also to be more aerodynamic with low air drag coefficients. These factors led to slanting glass and larger windows, which in turn let in more sunlight. Glass is transparent to visible light, which has the effect of heating up the car interior. The heat is retained in the car like a greenhouse and on sunny days in the tropics the temperature can easily exceed well over 100°C. In addition to dry heat the relative humidity can vary from 0 to 100%. These conditions are very severe for any material, especially textiles and many of the nylon car seats covers used at this time degraded, losing colour and tensile strength and abrasion performance. These experiences have deterred many OEMs to this day from using nylon as car seat covers in large volume production cars despite improvements in UV and light protection and the fact that in certain constructions the abrasion properties of nylon are probably the highest of any fibre. Earlier cars generally had smaller windows in which the glass was more or less vertical, and the conditions inside on sunny days were probably not as hot as in modern cars. In addition customers were possibly less demanding regarding the car interior, and competition between the car companies was also possibly less intense than today.

### 1.2.2 Modern seat covers

The most important requirements of car seat cover fabric are high abrasion resistance and resistance to UV degradation. The fabric must last the life of the car, well over ten years and must appear in first class condition, to maintain a good resale value, for at least two years. Most car buyers are not

mechanically minded and if the car seats look worn, they will assume that the engine and the rest of the car is also worn. The abrasion properties of fabrics depend to a certain extent on construction and the type of yarn, degree of texture, fineness of filaments etc. but also very significantly on the fibre type. Cotton and other cellulosic-based yarns such as viscose rayon and the new lyocell yarns have significantly lower abrasion resistance than nylon, polyester, acrylic and polypropylene. Acrylic has the highest light and UV resistance but falls down on abrasion compared to the other synthetic fibres. The material which has risen to prominence during the 1970s and 1980s and is now used in over 90% of all car seats world-wide is polyester. Even this fibre however requires to have UV light-absorbing chemicals added to the dye bath to pass modern rigorous standards of durability.

Polyester is helped by the fact that glass filters out the UV light radiation which harms it most, see Table 1.3 – other fabric properties appear in Tables 1.4 and 9.1. The excellent UV degradation resistance of polyester combined with very good abrasion resistance and relatively inexpensive price ensure that it will keep its prominent position among the available fibres. Other properties of polyester which make it ideal for car seat covers

*Table 1.3* Light durability of some natural and synthetic fibres exposed simultaneously

	Initial tenacity g/den	Outdoors (direct sunlight)		Behind glass	
		50% Loss	80% Loss	50% Loss	80% Loss
		Durability in Florida: months required to reach loss in strength indicated			
Acrylic, semidull	2.1	13.6	36 (72%)	19	36 (63%)*
Polyester, bright	4.2	3.7	7.9	24	36 (75%)*
Polyester, semidull	3.1 (spun)	4.0	9.1	36	36 (49%)*
Polyester, dull	4.2	3.6	8.0	20	36 (79%)*
Nylon, bright	5.3	9.5	17.0	10.3	20.7
Nylon, semidull	5.4	3.2	6.5	4.5	8.2
Nylon, dull	5.1	3.1	5.1	4.1	7.7
Rayon, bright	1.6	2.6	6.3	3.0	14.2
Acetate, bright	1.0	5.1	11.8	8.1	27
Cotton, deltapine	1.8	2.9	5.8	4.9	14.0
Flax, Irish	3.5	0.9	2.5	4.5	5.0
Wool, worsted	0.7	2.3	3.2	4.5	7.6
Silk	4.2	—	—	0.8	3.9

\* Loss per cent indicated after 36 months.

Source: Faris BF, (Dupont) in 'Automotive Textiles' (Edited by M Ravnitsky), SAE PT-51 1995. Copyright held by Society of Automotive Engineers Inc Warrendale, PA., USA. Reprinted with permission.

Table 1.4 Summary of properties of main fabrics used in automotives

	% Moisture regain at 65% RH	Acids	Resistance to alkalis	Solvents	Advantages	Disadvantages	Major applications
Polyester	0.4	Good	Moderate	Good	High abrasion. Good UV resistance. Relatively inexpensive	Low moisture absorbancy. Uncomfortable seats in summer. Limited compressed resilience – not used in tufted carpets	Seat cover fabric. Interior trim face material. Carpets (needle-punched). Functional non-woven applications. Seat belts. Tyre cords
Polyamide 6 and 66	4.0	Moderate	Good	Good	Good resilience and elasticity recovery. Good thermal absorption (for airbags)	UV resistance poor unless stabilized	Airbags, Carpets (tufted). Tyre cords

Table 1.4 (cont.)

	% Moisture regain at 65% RH	Acids	Resistance to alkalis	Solvents	Advantages	Disadvantages	Major applications
Polypropylene	0	Good	Good	Moderate	Inexpensive. Lightweight	Colouration limited. Low melting point. Low moisture absorbency	Interior trim face material (not seats) Carpets (needle-punched). Functional non-woven applications.
Acrylic	2.0	Good–moderate	Moderate	Good	High UV resistance. Soft handle	Moderate abrasion	Car roofs
Wool	12+	Good	Poor	Good	Comfortable Resilient	Relatively expensive. Low resistance to UV	Seat cover fabric in luxury cars

Notes: 1. Other fibre properties appear in Table 9.1.

2. All synthetic fibres have good soil resistance and good resistance to micro-organisms compared with natural fibres. Polyester, polyamide and polypropylene tend to retain oil soiling.

3. Polyester not used in airbags because of poor thermal energy absorption.

include, high tear strength, resistance to mildew, low water absorbency, allowing it to be kept clean relatively easily, excellent resilience and crease resistance. The latter property is helped by lamination to polyurethane foam. However, the low water absorbency in hot weather can result in thermal discomfort, and ways of improving this have been explored. Some acrylic fibres have been used, and a small quantity is still used, mainly in Italian cars. Acrylic fibre has excellent UV degradation resistance, is available in a variety of colours and has a soft handle but abrasion resistance is not especially good. The exceptional UV degradation resistance, especially when spun dyed, makes acrylic eminently suitable for car roof covers and for hoods for convertibles.

Wool is also used in car seat covers and has acceptable abrasion resistance in certain constructions but it is expensive and is generally used only in up-market cars. Wool is a hygroscopic fibre absorbing water vapour, and for this reason provides better thermal comfort than polyester. Wool can be made flame retardant to a high standard by the Zirpro process, which makes it very attractive for use in passenger-carrying vehicles, trains and aircraft.

The manufacturers of polypropylene fibres are trying very hard to have their material accepted for car interior trim.<sup>11-15</sup> It is less expensive than polyester, is claimed to be more easily recycled and is significantly lighter in weight. However at present its disadvantages outweigh the advantages. The most serious problem is that it cannot be dyed commercially in a dyebath, and the only commercially available coloured polypropylene yarns have been spun dyed during manufacture. Spun-dyed (also referred to as producer, solution or melt-dyed) yarns are only available in bulk quantities which goes against the present day requirements of flexibility and rapid response to colours in vogue, at a particular moment in time. Much research is being conducted to enable polypropylene to be dyed in dyebaths.<sup>15</sup> Other disadvantages of polypropylene yarns for use in car seats are the low melting point and limited abrasion resistance. It has even lower moisture absorbency than polyester and is therefore even more likely to be thermally uncomfortable in hot weather especially when next to the skin. Polypropylene however is used in non-woven fabrics as headliners, carpets and other areas of the car. Chemical stabilizers have improved the stability of polypropylene fibre to light and thermal degradation.<sup>13,14</sup>

### 1.2.3 Modern seat covers – the fabric producers' view

A prime requirement of any textile seat or door panel base fabric, is the ability to apply both a visual and aesthetic sense to the product. This may seem somewhat self-evident but many fabrics have been developed which

meet many of the needs of the OEM and Tier-1 stylists, but which are inflexible when it comes to surface decoration, and fabrics have suffered as a result of this. In addition base fabrics should be capable of design and colour variations on short development time scales.

One such product is double-needle-bar Raschel fabrics (DNBR), see Section 3.3, which is in many ways an ideal product with a pile surface, high production rates, low cost, some stretch for ease of engineering etc., but it lacks the ability to have large surface patterns applied easily and efficiently, without dramatically affecting cost. The result of this over recent years has been the fact that this technology has lost out to more 'design friendly' processes such as circular-knitted products.

Similar comments could be made of loop-raised tricot fabrics, where fabric aesthetics rather than surface pattern predominate. New ways of applying design to fabric such as ink-jet printing, however, mean that such fabrics could again come to the fore as print substrates and compete favourably with jacquard technologies which are at the moment dominant in the production of figured fabrics.

#### 1.2.4 Seat cover laminates

The seat cover fabric must always appear uncreased, and for this reason it is usually laminated to polyurethane foam, with a thickness varying from about 2 to 10mm. In addition it must resist soiling, be easily cleanable without ever being put into a washing machine. The lamination to polyurethane foam also imparts a soft touch to the fabric and when the seat cover is made up, deep attractive sew lines are formed. To help the seat cover slide along the sewing machine surface during sewing, and to assist sliding when the made-up cover is pulled over the seat structure, a scrim fabric is laminated to the other side of the polyurethane foam. The scrim also helps control the stretch properties of the seat cover especially when knitted fabrics are used. Thus the cover 'fabric' is usually in the form of a triple laminate for seats, but when used for door casings a bilaminate, i.e. without the scrim, is used. At the present time the most important technical requirements of a car seat covering fabric are cost, UV degradation resistance, lightfastness, abrasion resistance and soil resistance. The latter is a natural property of polyester, which can be improved by a fluorocarbon after-treatment if necessary.

The polyurethane foam to which the cover fabric is laminated can be of two general types, polyester polyurethane foam and polyether polyurethane foam. Polyester polyurethane foam has poorer hydrolysis resistance compared to polyether polyurethane foam and is generally used in northern Europe but not in more humid parts of the world. Some OEMs specify polyether polyurethane for all their fabric. In addition there are

flame-retardant (FR) grades of both types to different standards of flame retardation, the higher the standard, of course, the higher the cost. Polyether polyurethane foam needs to be modified slightly with certain additives to make it flame laminateable.

### 1.2.5 Textiles in other areas of the car

The decorative and soft touch properties of textiles are used in most other areas of the car interior, summarized in Table 1.4. The more functional uses of textiles generally demand very specific properties such as high tenacity and low shrinkage (important for tyres), high modulus (important for composite structures) and high temperature resistance (for belts and hoses). Specialist fibres have been developed and have found ready applications in the motor industry. In addition, textiles play a vital part in composites and rubber-based products, which have brought tremendous benefits – increasing performance and durability and saving weight. Non-woven fabrics are used extensively for both functional and decorative applications in the car and the amount used is increasing slowly but steadily to replace more expensive covering materials and in other numerous applications, see Section 3.6. The use of non-woven material to replace polyurethane foam has been explored extensively but so far with only limited success. The use of fibres in composites is likely to increase as more success is achieved in replacing heavy metals with lighter plastic/fibre combinations. Natural fibres, which are a replaceable natural resource are being examined carefully for this application and some technical advantages have been identified.

## 1.3 Material survey – plastics

Some mention must be made of plastics and their properties because automotive textiles are almost invariably joined to or used in conjunction with plastics; indeed synthetic fibres are themselves plastics and have the properties of plastics. Table 1.5 summarizes the main materials used in car interiors. Textiles are now processed using techniques originally designed for plastics alone such as the various moulding procedures. The durability requirements of plastics inside the car are of course similar to those of textiles. In some cases they are even higher. For example, the dashboard in virtually all cars is mostly plastic, and it is directly under the windscreen – the hottest part of the car. The use of plastics in car manufacture has grown very considerably over the last 25 years and will continue to grow, especially in the form of composites. Several ‘all plastic’ concept vehicles have appeared over the years. Plastics have allowed freedom of design and

Table 1.5 Summary of materials used in car interiors

Component	Decorative cover face material	Intermediate or soft touch	Carrier or rigid structure
Seats	Polyester fabric (woven/knitted), Wool, Wool/polyester blends (woven), Leather	Polyurethane foam, Polyester non-woven	Cushion/squab, of polyurethane foam, Metal frame
Door panels	Polyester fabric, PVC, PVC/ABS foil, TPO foil, Polyurethane foil, Leather	Polyurethane foam, Polyester non-woven, PO foam, PP foam	Wood fibre, PO/wood fibre, PP/natural fibres, PP/glass fibre, PP/talc, PU/glass fibre, PU/natural fibres
Headliner	Polyester non-woven, Knitted nylon/Polyester, PVC foil	Polyurethane foam, Polyester non-woven, PO foam, PP foam	Semi rigid PU foam/fibre glass, Resinated shoddy fibre, Cardboard
Parcel shelf (Package tray/hat rack)	Non-woven polyester, Non-woven Polypropylene	—	Wood fibre, Resinated shoddy fibre, Polypropylene PU/glass fibre
Sunvisor	Polyester fabric, PVC foil	Polyurethane foam, Polyester nonwoven PO foam	Semi rigid PU foam, Cardboard, Metal frame
Carpet	Nylon fibre, Polypropylene fibre	—	Polyester non woven/SBR latex binder, Polyethylene for mouldability, Acoustic barrier of EPDM, Resinated shoddy fibre/PU foam, PU foam
Dashboard (Instrument panel)	PVC/ABS, PVC, TPO, Polyurethane foil	(Expanded) PVC, PP foam	PVC, PVC/ABS, Polyurethane, PU/glass fibre, PP/talc Metal
Bootliner (Trunkliner)	Polyester non-woven, Polypropylene non-woven	—	—
Bonnetliner (Hoodliner)	Polyester non-woven Polypropylene non-woven	Polyurethane foam	Resinated shoddy fibre, Fibreglass, Polyurethane foam
ABC pillars	PVC/ABS, PVC, PU or TPO foil	Polyurethane foam, PP foam, Polyester non-woven	PP, PVC/ABS
Airbag	Nylon 66, 6, 46 woven	—	—
Seat belt	Polyester woven	—	—

TPO, thermoplastic polyolefin; ABS, acrylonitrile-butadiene-styrene; PP, polypropylene; PU, polyurethane; PO, polyolefin; PE, polyethylene; EPDM, ethylene – propylene – diene monomer rubber.

styling as more creative shapes can be produced in plastic compared with metal or wood.

The versatility of plastics has also allowed significant weight reductions, and more economical production methods, by permitting the integration of several parts and processes. An example is in-mould lamination to the décor material, which can be a textile or a foil, without adhesives. This single process replaces the separate production of the rigid part which then, in another separate process, needs to be joined to the face décor material. This technology is becoming more sophisticated, enabling more complex shapes and parts to be produced faster, more economically and with more consistent quality. However the production volume must justify the tooling costs. More mention will be made of this subject in Chapter 6. The Association of Plastic Manufacturers in Europe (APME) has pointed out that 100 kg of plastic in a modern car will have replaced between 200–300 kg of conventional material. Over the life span of the car, this results in very considerable savings of oil, which is estimated at 12 million tonnes per year in Western Europe.<sup>16</sup> Carbon dioxide and other exhaust emissions are also substantially reduced.

Plastics can be broadly divided into two types; thermoplastics, which soften and eventually melt when heated and thermosets, which do not soften or melt when heated. All plastics are made from long-chain linear polymer molecules but in the case of thermoset plastics, the molecules are cross-linked, which makes the whole structure more rigid and prevents them moving when heated. With thermoplastics, the long-chain molecules are free to move about more when heated above certain temperatures specific to the particular molecular length and chemical nature. Thermoplastic properties of some plastics are useful in that they allow the material to be used as hot-melt adhesives and in certain cases allow the material to be joined by welding techniques.

In general terms for a given chemical type of thermoplastic, the shorter the molecular length, the lower the melting point, and the longer the molecular length, the higher the melting point. Adhesives are generally shorter-chain-length molecules and melt at relatively low temperatures, for example polyester fibre melts at about 260 °C, but there are polyester-based adhesives which melt as low as 100 °C. The thermoplastic nature influences the ease with which recycling can take place; if thermoplastic, the material can be melted down and reprocessed into the same or another useful article. Thermoset plastics are not as easily recycled, and for this reason thermoplastics are generally preferred over thermoset materials – if there is a choice. Thermoset plastics are harder, more rigid and more heat resistant but the vast majority of plastics are thermoplastic.

The main plastics used in combination with fabric are, polyurethane foam, and adhesives based on polyurethane, polyethylene, polypropylene,

polyamide and polyester. Covering materials (coverstock), inside the car, other than textiles and leather, are thermoplastic films (sometimes called foils), made from PVC, PVC/ABS, polyurethane, and polypropylene. Plastics are also used in rigid components of the car interior such as the dashboard, pillars, door casings and the rear parcel shelf. There are of course very many other applications of plastics and advanced plastic materials in all other areas of the car. Tables 1.4 and 1.5 summarize the textiles and polymer types used in the car interior.

It is important to realize that a 'plastic' generally consists of the plastic itself plus several additives. Amongst these are UV radiation and heat stabilizers, antioxidants, fillers to improve the mechanical properties, fillers for economy, flame-retardant chemicals, reinforcement fibres (turning the plastic into a 'composite' – see Chapter 9), pigments and other compounds necessary to confer further special properties or to assist with processing. Sometimes it is necessary to add materials specially to make all the various ingredients compatible with each other. When fibres are added or when the compound is to be coated onto a fabric, coupling or bonding agents – also called adhesion promoters – may also be required. Plastic compounding or mixing of components is a specialized process and if not carried out correctly, it can cause production problems and variations in quality. In addition, volatile compounds can cause fogging in cars, see Chapter 5. Furthermore there are many variants of each chemical type and the terms 'polyurethane' or 'polyester' in fact refer to families of polymers of related chemical constitution and not just a single type.

## **1.4 Material survey – natural and synthetic rubbers**

These materials are closely related to plastics and are used in combination with textiles in many parts of the car. Similar to plastics there are various types to suit different applications and they are versatile in that they can be blended together and additives can be mixed in to provide specific properties. The largest application by far for rubber is the tyre, which accounts for about 50% of all rubber production in the world. However there is not enough natural rubber available and so this has to be supplemented with synthetic rubbers especially styrene butadiene rubber (SBR). A number of specialist rubbers which are widely used in transportation applications are nitrile rubber, butyl rubber, polychloroprene, the best known of which is Neoprene (DuPont) and chlorosulphonated polyethylene, the best known of which is Hypalon (DuPont). These more specialist materials are used widely in fabric-coating applications, which are described in more detail in Chapters 7 and 9.

## 1.5 Requirements from suppliers

OEMs and also their suppliers, the Tier-1s and -2s, in fact everyone associated with car construction or the supply chain require unfailing reliability in terms of delivery on time, quality and suitability for efficient use. Suppliers must also be prepared to accept and respond to fluctuations in the market place. A selection of OEMs, Tier-1s and textile producers in the auto industry appears in Table 1.6. A new potential supplier's past performance is examined, and his facilities inspected and audited to reassure the purchaser of his ability to produce quality goods at the required time. The supplier is expected to conform to a recognized quality procedure such as ISO 9000. These procedures are very wide ranging, covering all management functions including, sales and marketing, production, research and development and personnel.

There are certain aspects which are peculiar to the automotive industry, and to meet these, the three major American car makers, General Motors, Ford and Chrysler collaborated to produce QS 9000. This quality-assurance document is based on the ISO 9000 series, but tailored to meet these special requirements. Quality is discussed at length in Chapter 5. Supplier quality requirement manuals are now issued by customers, which detail the actual procedures and mechanisms of doing business. In response many suppliers now declare that their aim is to provide total customer satisfaction and indeed aspire to exceed customer expectations.

OEMs expect their suppliers to become long-term partners who not only deliver quality goods JIT but are also capable of correcting any problems of supply or quality quickly and efficiently. Non-conformance and concession forms are issued if performance properties are not entirely within specifications. Documented action plans should be in place for multidisciplinary teams to tackle problems should they arise, so that the causes are located quickly, corrective action is taken promptly and more importantly, recurrence is prevented. Techniques such as failure mode and effects analysis (FMEA) and statistical process control (SPC) are expected to be in operation.

OEMs and their suppliers operate supplier merit systems, whereby suppliers' performance is assessed and reviewed at least annually. Awards and certificates are made to those companies whose performance has been outstanding in terms of quality and delivery JIT. These annual awards encourage and reward the efficient suppliers but also act as a 'league table', so that those companies who do not rank high can strive to improve their performance over the coming year.

The prices OEMs pay for the goods are expected to be the lowest possible and the supplier is expected to continuously strive to lower this even

**Table 1.6** Some major producers in automotive textile engineering

**1.6.1. Original equipment manufacturers (OEMs) car makers**

General Motors	Fiat
Ford	PSA Peugeot/Citroen
Toyota	BMW
DaimlerChrysler	Porsche
Renault/Nissan	Mitsubishi
Volkswagen	Daewoo
Honda	Hyundai

**1.6.2. Heavy goods vehicles (over 6 tonnes gross vehicle weight) manufacturers**

DaimlerChrysler (Freightliner)	ERF
Navistar (formerly International Harvesters)	MAN
RVI, Renault (Mack)	General Motors (Bedford)
Ford	Isuzu
Volvo/Scania	Dongfeng
Paccar (DAF, Forden, Kenworth, Peterbilt)	Hino
Iveco, Fiat (Magirus Deutz, Unic)	Mitsubishi

**1.6.3. Some Tier-1 suppliers**

<u>Company</u>	<u>Main activity involving textiles</u>
Delphi	Seating, airbags
Visteon	Seating
Johnson Controls	Seating, headliners, door panels
Lear	Seating, headliners, door panels, floor systems
Magna	Seating, door panels
Textron Automotive	Seating, door panels
Ikeda Bussin	Seating
Collins & Aikman	Floor systems, door panels, interior trim
Treves	Seating, door panels, floor systems
Sommer Allibert	Door panels, headliners, interior trim
Faurecia	Seating, door panels
Rieter	Floor systems, interior trim
Autoliv	Airbags, seat belts
TRW	Airbags, seating
Toyoda Gosei	Airbags
Toyko Seat	Seating, door panels, headliners

**1.6.4. Some automotive fabrics suppliers**

<u>Woven/knitted Fabrics</u>	<u>Non-woven fabrics</u>
Collins & Aikman	Freudenberg
Guildford Mills	Cosmopolitan
Milliken	Lohmann
Joan	Fibertex
Viktor Achter	Lantor
Achter and Abels	Fiberduk
De Witte	US Nonwovens
Aunde	National Nonwovens
Borgstena	Texidel
Axelsons	Dexter
Deutsche Bobinet	Libeltex
Eybl	BFF Nonwovens
Thiery	Sandler
Fidivi	Sommer
Kawashima	
Seiren	
Suminoe	
Trèves	

Compiled from various sources including:

1. 'Automotive & Transportation Interiors' Special Report August 1999.
2. *FT Auto*, 3 December 1999.
3. Wilkens C, 'Automotive Fabrics', *Knitting International* August 1995, 52.

further without compromising quality in any way. Furthermore the supplier is expected to improve his product and to work with the OEM to find more economical ways of achieving the same objective with alternative or more advanced methods or materials. Everyone is expected to strive for zero defects and to be constantly looking for ways to improve performance and to shorten delivery times further.

Suppliers, especially the Tier-1s are also expected to innovate and research new products and develop more cost-effective processes. They are therefore expected to have research, development and design teams and facilities, together with market researchers and analysts to keep up to date with new concepts in a constantly and rapidly changing world. Development times to market must be as short as possible and ways of shortening them further should be constantly researched. The Tier-1s may develop products for different OEMs, which may ultimately compete with each other in the marketplace, and of course confidentiality must be respected. However, if a fabric company develops a new fabric or design they may be required to make all the information available to one of their competitors so that the OEM or Tier-1 can have two suppliers.

The environment is being taken seriously by OEMs and from 2006 they will be responsible for taking back all scrap cars for dismantling, recycling and disposal. OEMs will be seeking for contributions and assistance in this task and will look favourably on suppliers who are able and willing to do this. Already some major OEMs require a recycled content in components supplied. It is in order to create a positive image for the industry as a whole that the OEMs and their suppliers strive for a cleaner environment, and the ideal of 'sustainable development'. Many companies already have successfully registered for ISO 14001. These aspects are discussed in Chapter 8.

In the modern automotive industry, suppliers are expected to be capable of supplying JIT anywhere in the world, and to provide prompt technical service and sales support anywhere in the world. Needless to say they are expected to exhibit confidence, management stability, efficiency and professionalism, a positive, forward proactive approach and to be innovative and constantly searching for increased productivity and quality. The automotive industry pioneered the modern methods of mass production, i.e. assembly line manufacturing and JIT delivery. It has become a truly global industry and many see it as a future model for other industries. There are regular special requirements conferences held to inform, discuss and develop new concepts and procedures necessary to be an efficient supplier to the automotive industry. Modern communications technology is revolutionizing ways of conducting business and there are exciting new possibilities offered by the internet to improve efficiency and reduce costs.

## 1.6 References

1. Lebovitz R, 'Shedding new light on interiors', *Automotive & Transportation Interiors*, March 1998, 4.
2. Benisek L, 'Global focus at man-made fibre event', *Textile Month*, November 1997, 8–16.
3. Robertson P, *The New Shell Book of Firsts*, London, Headline Books, 1994, 214–25.
4. *AA Book of the Car*, London, Drive Publications, 1970, 8–10.
5. Guide Book to the British Road Transport Museum, Coventry.
6. Nunn P, 'Japan's rational revolution', *FT World Automotive Manufacturing*, June 1998, 14–16.
7. Lorenz A, 'Ford slams brakes on parts prices', *Sunday Times Business News*, 22 October 1995.
8. Sullivan LE, 'System integration; the race is on', *Automotive & Transportation Interiors*, June 1997, 20–3.
9. Anon, 'Life in the fast lane', *Nonwovens Report International*, (311) March 1997, 23.
10. Anon, 'Car components under pressure', *PRW*, 5 September 1997.
11. Editors of American Fabrics Magazine, *Encyclopaedia of Textiles*, 3rd edn, Englewood Cliffs, New Jersey, USA, Prentice-Hall, 1980, 393, 496–9.
12. Garner C, 'Polyolefin and the 10 year automobile', *ATI*. February 1996, 75–8.
13. Todesco RV, Diemunsch R & Franz T (Ciba), 'New developments in the stabilisation of polypropylene fibres for automotive applications', *IMMFC*, Dornbirn, 20–3 September 1993.
14. Eng JM, Samuels S-B & Vulic I, 'Developments in UV stabilisation of PP fibers', *Technical Textiles*, 42 April 1999, E25–E26.
15. Ruys L, 'Chromatex-A dyeable polypropylene – a breakthrough in solving an old problem', *IMMFC*, Dornbirn 17–19 September 1997.
16. AMPE leaflet, 5003/GB/01/97. 'Weight reduction, fuel efficiency and plastics, driving forces for the car of tomorrow'.

## 1.7 Further reading

1. Anon, 'Plastics in cars promise quality not compromise', *BPR*, October 1999, 51–8.
2. AMPE booklet 2008/GB/07/99, 'Plastics, a material of choice for the automotive industry'.
3. Corbman BP, 'Textiles, Fiber to Fabric,' 6th edn, New York, McGraw-Hill, 1983.
4. Crawford RJ, 'Plastics Engineering', 2nd edn, Oxford, Pergamon Press, 1987.
5. Gordon Cook J, 'Handbook of Textile Fibres', Vol. 1 – Natural Fibres, Vol. 2 – Man-made fibres', Both 5th edn, Shildon, Co. Durham, Mellow, 1984.
6. Grace K, 'Polymers are crucial for motor industry to meet its aspirations', *BPR*, 1996, 26–30.
7. Hatch K, 'Textile Science', St Paul, MN, USA, West Publications, 1993.
8. McCrum NG, Buckley CP, Bucknall CB, 'Principles of polymer engineering', Oxford, Oxford University Press, 1997, 7–18, 296–368.
9. Moncrieff RW, 'Textbook of Manmade Fibres', 6th edn, London, Heywood, 1975.

10. Newman S, (Ford), '*Encyclopaedia of Polymer Science and Engineering*', Vol. 2, New York, John Wiley, 1985, 117–43.
11. Ohno T, '*Toyota Productivity System*', Cambridge MA, USA, Productivity Press, 1988.
12. Roff WJ, Scott JB & Pacitti J, '*Fibres, films, plastics and rubbers (A handbook of common polymers)*', London, Butterworths, 1971.
13. Rosato DV, '*Plastics Processing Data Handbook*', 2nd edn, London, Chapman and Hall, 1997, 1–120.
14. Sloan AP, '*My years with General Motors*', New York, MacFadden, 1965.
15. Womack JP, Jones DT & Roos D, '*The machine that changed the world*', New York, Rawson Associates/Macmillan, 1990.

## 2.1 Interior design

### 2.1.1 The background

The importance of interior design to the potential sales volume of passenger cars has always been a major consideration to the automobile stylist. However, despite the fact that textiles had for a long time played a part in automobile manufacture it was not until the early to mid-1970s that these same companies began to realize the role that well-designed textile fabrics could play in the design of attractive interiors.

The reason for this was probably twofold. First, cars were largely designed by engineers, who, although talented, were not usually trained in any textile technology and so they relied upon their suppliers to alert them to developments. They tended to develop tried and trusted products due probably, then as now, to the 'huge cost of getting it wrong'.

The second reason was that up until this time the textile industry had not come to regard the automobile industry as a major market for aesthetically designed fabrics. This again was probably due to problems with performance in that the existing technologies struggled to produce products which could withstand the critical requirements of abrasive wear and high lightfastness. The products that could meet the criteria were usually unexciting fabrics, probably piece dyed, which offered little design potential.

Three major developments in the early 1970s conspired to change this situation. The first was the oil crisis of 1973–4 when the Middle East oil producers precipitated an artificial shortage of oil world-wide which in turn increased prices dramatically. This caused a swift reaction in Europe and Japan, not as quickly reflected in the US, to 'downsize' the product and make smaller, cheaper and more fuel-efficient cars. The laws of aerodynamics ensured that gradually, many of them began to assume similar shapes to reduce drag factors to a minimum. This in turn encouraged design-



2.1 Air texturized continuous filament yarn.

ers to look for new ways to differentiate the product, and interior trim design assumed a new importance.

It was also around this time that, in Europe, ways of improving the abrasion and lightfastness of textile fabrics had led to the development of continuous filament air-textured yarns. These yarns were produced by interlacing the filaments under the influence of air jets and had the effect of producing a yarn where the filaments were looped around the yarn axis with these loops being fixed due to the interlacing effect, illustrated in Fig. 2.1 [See Chapter 3 for a fuller description].

The development of high lightfast dyes was also under way by specially selecting disperse dyes for polyester which could either be produced through the yarn package-dyed method or by applying the dye to the polyester chips before extrusion to produce 'spun-dyed' filaments which could be combined in various ways to make 'colour-spun' air-textured yarns.

The technical suitability of polyester for the automotive market together with the expansion of world-wide production which tended to stabilize prices and the development of suitable yarns and fabrics created an ideal situation. The result of these developments was to create a market for more adventurous trim fabrics at a time when the technology to produce them to the necessary quality and performance standards was just coming on stream.

It was at this time that textile companies began to realize the potential of the car market which, unlike the majority of businesses they were used to supplying, was free of any preconceived ideas about what constituted a good design but was eager to see all new design ideas and developments of every type. A new business was opening up for the traditional fabric designers and suppliers, a business which they were soon to find was unlike any other they had experienced in terms of its quality and performance requirements. Many producers dipped their toe in the water but most quickly withdrew it when they discovered the high entry cost in terms of the investment required in different technologies, up-front development cost, quality issues, and very long time scales involved to recoup this investment.

Courtaulds Automotive Products (CAP), which was formed in 1978, was among the early entrants into this area and was one of the first to make concentrated efforts to design specific ranges for interior trim in innovative yet technically sound fabrics. The use of coloured yarns to produce these fabrics established a trend which was to see enormous growth due the vast

increase in design and colour potential offered. World-wide presentations mounted by CAP and other participants in the early days ensured that the message was spread far and wide.

Early design ideas were based largely around apparel and suiting design with colour and weave and simple dobby effects comprising a large part of many collections. The Japanese companies in particular were eager to see what Europe was offering in terms of design and colour, in what eventually turned out to be a precursor to their involvement in setting up manufacturing plants in Europe and particularly the UK.

Free-form jacquard designs followed, first in flat woven structures and then in pile structures, as the technology was developed. The range of fabric technologies from which the interior-trim designer could select was suddenly mushrooming with new products becoming ever more sophisticated due to the continuing development of alternative fibres, yarns, dye-stuffs and fabrics. Some succumbed to the temptation to go overboard with the design of interior fabrics sometimes to the detriment of the interiors, others trod a more cautious and sophisticated path and used design to best effect rather than simply to attract attention.

Eventually design 'styles' started to emerge with the more conservative, perhaps understated and often self-coloured designs appearing in the more expensive up-market models – often these designs were based on geometric principles. Other companies in the mass market began to experiment with larger-scale motifs and frequently used campaign models (these are often variants on existing models using exterior and interior design to either lift flagging sales or experiment with new ideas) to try out bold colourations. In this area particularly, the effect that different cultural approaches to design and colour had on the trim material, soon became apparent. The trained observer in Europe was able to tell which companies had retained design control in their native land whether it be Japan, America etc and which had delegated responsibility to stylists living and trained in Europe.

### 2.1.2 The challenge for the textile supplier

This evolving situation began to pose serious problems for both the supplier and also the car company. The textile manufacturer and supplier, in order to meet the expanding requirement, had to invest much more heavily in true textile design studios with full customer-support facilities dedicated to the requirements of the automotive industry, this in turn put pressure on finding and training qualified designers and establishing training systems.

The development of CAD helped improve work flow and reaction times to customer requirements but again demanded ever more qualified personnel. The automotive company expectations increased in direct pro-

portion to the ability to meet them. What is just possible today, is normal tomorrow, and unacceptable the day after!

Eventually the OEMs became aware that in order to fully appreciate and realize the potential of textile design for interiors they had to know more about it so they started to employ qualified textile designers and technicians. Stopping short usually of designing actual fabric they created ever more sophisticated design briefs for their suppliers, who in turn had to satisfy the requirements of the stylist while at the same time keeping a sharp eye on what the trim engineer wanted, in terms of fabric physical properties, and the laboratory, in terms of test procedures and results. It was and certainly still is the conflicts created by these three areas which present the fabric designer and supplier with the greatest challenge, and, it must be said, greatest dilemma.

### 2.1.3 Design support – hardware and software requirements

It is tempting to say that all these problems are in the past and all is now plain sailing. Unfortunately this is not the case and the dilemmas still exist, although advances in technology have meant certain issues such as light-fastness, for example, today do not present the same difficulties of say 10 to 15 years ago. However other challenges are always coming along. Stretch for instance which was quite a nice thing to have and usually a bonus in the early days has now become a prerequisite for many programmes where complex seat or door panel shapes are involved. This particular parameter has become a closely defined requirement with many Tier-1 suppliers, who are always experimenting with new and more adventurous seat and door panel shapes. Certain physical properties quite simply may be impossible to achieve in the chosen fabric technology so it has become necessary for the suppliers to become competent in all fabric-production techniques and also be able to transfer designs across technologies as and when required.

To the automotive engineer this seemed like a reasonable request, to the textile company with a 100-year tradition of specialization in one or at most two technologies it was certainly, in the early days, something of a revolutionary approach and many found great difficulty coping with the requirement.

The demands the various OEMs place on their fabric suppliers are in principle very similar. They require reviews of new products under development and regular design presentations, sometimes general, sometimes targeted. Car models are defined and designs short-listed and selected, colour and design modification work starts with fairly well-defined critical paths and timings. Technical considerations in terms of fabric performance to a standard test procedure have to be addressed and again modifications

made to ensure laboratory approval. Increasingly the demands of the seat engineer are part of the fabric-development process to ensure that it can be trimmed efficiently.

Today's fabric designer has to cope with all these conflicting issues often in direct competition with competitors, maybe across several fabric technologies and on extremely short time scales for submissions following development meetings and they must never lose sight of the fact that styling aesthetic approval is key to obtaining the business. The designer is in effect the front-line sales force in most textile companies supplying the automotive manufacturer – unless the fabric, design and colour is developed and approved it cannot be sold!

It is possible to segment the process and adopt various approaches to meet the requirement:

Creative work non-specific in terms of customer or technology.

CAD operations to convert creative work into hard copy.

Pilot fabric production to produce new concepts and ideas.

Train designers to specialize in one technology across all accounts – or train designers to specialize on one account across all technologies.

Involve technical specialists to handle the technical fabric development.

Establish a central design studio to 'pool' ideas and maximize creative potential – or consider locating design studios geographically close to customers to assist communication and support.

Involve designers in technical issues related to engineering requirements or free designers from technical issues to concentrate on the creation of new ideas.

How these issues are dealt with, will, over time, lead to an internal design culture which will be recognized by the customers.

A fabric producer will become known as 'highly creative and design-led' or maybe 'technical and engineering-led'. It is a difficult task to be completely successful in both areas all the time even though this should remain a prime objective for automotive textile producers.

Most textile manufacturers with a history of production for non-automotive uses will be familiar with the notion of specialization in one fabric technology to supply various end-uses, requiring a specialist approach to the technology and a flexible approach to the end use customer.

To some extent the automotive industry turns this traditional idea on its head in that the producer has to adopt a specialist approach to the customer and a flexible approach to the fabric technology which may be required. The effect this situation has on the designer is best illustrated by Fig. 2.2. It is also important to recognize that different car companies place the emphasis in different areas, sometimes due to internal politics or maybe

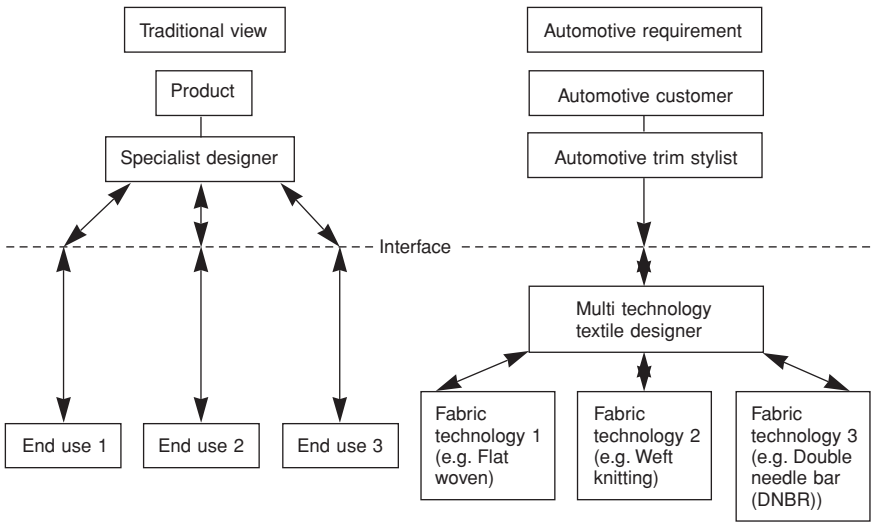

2.2 Comparison of traditional textile and automotive textile design requirement.

cost constraints or even past problems or costly mistakes. These are further additional issues which have to be taken into account.

Any design manager or director has to juggle with all these options plus others and decide which permutation will work best for him and his company and of course for his customer. In order to do this it is important to have in place the necessary tools to do the job, these can broadly be divided into computer aided design (CAD) assistance and pilot-plant facilities to quickly make actual fabric samples.

### 2.1.3.1 Computer-aided design

In today's environment surface pattern design cannot really be undertaken without resorting to the specialized CAD packages which, in the case of woven fabrics, enable ideas to be quickly scanned into the computer and manipulated. They then have to be put into repeat and separated out into colours which represent weave effects. Weaves have to be applied to these colours before a woven simulation can be produced on a colour printer.

Weaving instruction and floppy disk or electronic instruction to program the loom selections are the final requirement prior to weaving the fabric.

The same process is applied to knitted fabrics, but in all cases it is necessary to have a starting point for the creation of the original idea and this can either be done manually or by the use of some non-specific creative CAD package or more probably by the combination of both.

Computer screen showing yarn type and colour design application, which is included in the fabric design to create realistic fabric simulation when printed out

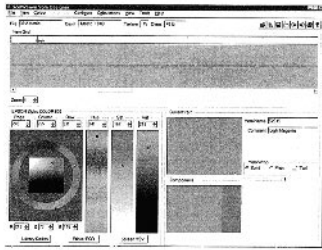

Jacquard design indicating weaves applied to various colours in the design

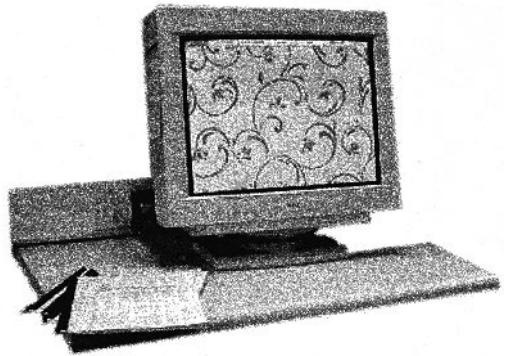

2.3 CAD visualization of a jacquard-woven fabric at the design stage with yarn design simulation inset. (Yarn design reproduced by kind permission of SCOT Innovation and Development Ltd.)

This requirement for efficiency and speed has created a near total reliance on CAD particularly in automotive fabric design where designers are called upon to work on several fabric technologies at the same time and the search for suitable CAD packages should be done thoroughly and with care.

One company who devised and developed a CAD package from a designer's viewpoint starting from a basic knowledge of design is ScotWeave originating from the Scottish College of Textiles and now developed and marketed by ScotWeave Ltd., Galashiels, Scotland, and sold through Jeftex Ltd., Rochdale, Lancashire.

ScotWeave provides flat-woven and woven velvet program for dobby and jacquard designs which allow for yarn-count characteristics and profiles to be stored ready for applying to specific designs. They also enable the universally recognized CIE (Commission Internationale l'Eclairage) colour definitions to be applied for accurate colour rendering and for the final fabric to be reproduced, by the application of contour grids, as a virtual three-dimensional (3D) simulation applied to the object whether it be a car seat or room setting.

Figure 2.3 shows the screen simulation of a flat-woven jacquard fabric where each individual thread interlacing can be checked manually or automatically and inset can be seen the yarn design application which is usually done prior to creating the fabric so that a realistic simulation of the cloth can be created when the image is printed out.

Figure 2.4 illustrates a 3D fabric simulation *in situ* on the model.

The universal acceptance of CAD in the designing of fabrics, both woven and knitted, has led to an enormous shortening of lead times from idea to

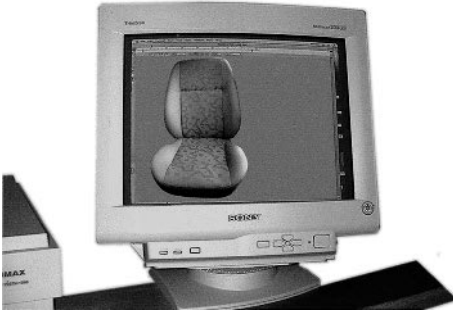

2.4 Simulation of car seat with woven fabric mapped on to surface to resemble 3-D model.

realization which is now accepted as the norm and no one can really operate successfully in the market without a significant investment in CAD.

The importance of having pilot plant available for quickly producing aesthetic and technical samples on short lead times during the development process cannot be overemphasized, and to have this easily accessible to the designers is a great advantage. Obviously the more fabric technologies involved, the more complex and expensive this process becomes. It is, however, difficult to efficiently service the customer base and establish a reputation for innovation and creative work without it.

The overall objective is to retain maximum creativity while at the same time meeting all the other technical and commercial pressures which are inevitably applied in the development of new products.

#### 2.1.4 Design education

It is apparent from the above descriptions that designing textile trim fabrics for automotive use, although exciting and eventually rewarding, is complex and multifaceted and the importance of a good grounding in all aspects of design during the degree courses cannot be overemphasized. Some universities place a lot of emphasis on close contacts with industry to produce what employers want, others take a different view and prefer to give more freedom of expression leaving the realities until later when the graduates start work. Both approaches have advantages and disadvantages but irrespective of the curriculum it is in the long-term interest of the automotive textile producer to create close contacts with colleges and universities to sponsor special projects for students, take students on secondment, be prepared to give talks and lectures on the special requirements of the automotive market. These activities ensure that the the education process produces graduates who have at least a basic knowledge of what is required

and do not have such a traumatic time adjusting to the strict requirements of the business.

In the UK it is possible, with the excellent range of quality courses and large number of students studying design, to find graduates who are capable of fulfilling the role described and, although other countries have different systems, it is significant that many automotive companies have taken advantage of the UK university courses to staff design studios in Europe and further afield.

### 2.1.5 Design development

The requirements of the OEM trim stylist is only one of the issues which the textile designer has to meet. For any fabric to progress to successful mastering against a model programme it must also meet the technical needs of the Tier-1 suppliers – i.e. the manufacturers of the seat and door panels. They must also pass through the laboratory testing procedures laid down by the OEM and be accepted aesthetically not only by the stylists but also by marketing and any other critical areas which the OEM might decide need to have design appeal. Price also is of prime consideration. Many of these issues will probably be referred to in the original design brief but often change as the fabrics progress through the design process.

It is not surprising, therefore, that additional expertise over and above that provided by the fabric designer is inevitably required – this assistance requires input from the technical and commercial departments within the company and it is an important part of the designer's job to see that the original design concept or vision is not sacrificed by the pressures of complying with all the other conflicting requirements.

Two major decorative uses for textile products are 'apparel' and 'furnishings', each of these areas has a long history of textile production – long enough in fact to have attained a definite design 'history' of their own with design styles moving through traditional, modern, geometric, avantgarde etc. etc. as fashion trends dictate. Included in this process are the favoured yarn and fabric technologies which provide the product with the latest in preferred aesthetics – crisp or soft hand – bright or dull lustre – firm or stretchy etc. etc.

By contrast, decorative automotive textiles have only just started to attain an 'applied design' character of their own. In the early days (and we are only talking about 20–25 years ago) the industry 'borrowed' design styles from first the apparel and then the home-furnishing sectors and tried to translate these into structures which could be approved for automotive trim. This translation process caused much of the original aesthetic attractions to be lost due to toning down of the colours, amendment of structures such as the shortening of floats to improve abrasion in the woven structures,

and also to approve fibres and yarns – mainly textured polyester for the bulk market – being unable to support the demands of the designer in terms of handle, lustre etc.

During the past 20 years or so the situation has improved considerably with improvements in the technology of yarn and fabric production. In terms of surface pattern the automotive industry has started to gain an identity of its own with the various styling departments today having fairly clear ideas as to what designs are suitable for sports-level, base-level, luxury-level etc., in most cases these ideas are defined within a company and are likely to differ considerably between companies. In this way, of course, badge identities are promoted although a fairly common theme across most car companies would be for design and colours to become more restrained or understated as they progress up the model ranges. Now that more fabric-producing technologies are available to the stylists and fabric designers it is possible to visualize designs and concepts on various substrates requiring yet another selection process to be included into the development programmes.

It is the responsibility of the designers from both the fabric supplier and the OEM between them to consider proposals which cover all the options of fabric technology, structure, design, colour etc. before narrowing down the choices as the design process proceeds.

### 2.1.6 Interior styling issues and cultural preferences

There are issues, some technical, some cultural, some perceived, which can have a definite influence on the choices of design and fabric technology for any given model programme. Although briefly referred to earlier it may be interesting to consider these in slightly more detail.

The manager or director charged with the responsibility of creating an interior for a new model has many issues to consider, of which the type design and colour of the trim fabric is but one, albeit an important one. Some of these are technical – it is necessary to work within the achievable while constantly striving to push out the barriers, and some are aesthetic – the interior as a whole has to work and items have to be seen to complement each other. There will probably be an overall concept or idea of what the car and the interior of the car should convey to the end user. This concept or target can usually be summed up in a few words or phrases such as; ‘extravagant’, ‘simple elegance’, ‘Innovative’, ‘Sporty’ used to transmit an overall idea. Another equally important concept is the target market: ‘20 to 30-year-old single women’ or ‘50 to 60-year-old retired couples’ or ‘family-orientated purchasers’.

Then there is the geographic location of the major sales area. The same concept could mean a very different thing in terms of trim material to a

purchaser in Tokyo compared with a purchaser in Trinidad or even Tunbridge Wells. Apart from any differences in design and colour the actual material conveys different images in different places. This is noticeable, particularly with regard to the attitude towards printed materials which are now becoming increasingly available. In Europe, generally print except in terms of printed silk, is not usually regarded as an up-market product but in Japan this is not the case and very expensive substrates are printed. In America, fabric trim in general is perceived much further downmarket than leather although velvet takes a larger share of the market in the US than Europe where it is regarded as a relatively cheap option although a *wool*-blend velvet is regarded here almost on the same level as leather. It is necessary therefore for the textile designer to have a close association with the interior trim stylist in assessing all these ideas before serious work commences on the product.

Textile products generally have the advantage that once the substrate is approved the changing of the design and the colour is a relatively simple task for the producer but unfortunately the mastering systems of most automotive companies slow even this process down to turn what should be a simple decision into a fairly big issue. Textiles in general are in competition mainly with leather when it comes to modern trim materials and when it comes to surface decoration, there is little option but to specify a textile product. Although printed leather is available it tends to detract rather than add to the aesthetic and perceived 'quality image' of the product.

This means that the choice of which textile technology to specify is becoming an increasing problem and for the textile supplier it is becoming ever more necessary to have a detailed technical knowledge and capability in all the available technologies so that all the available options can be tried and tested as and when required.

The recent expansion in options for trim material has created one unfortunate problem with which all interior stylists have to contend and that is how to take advantage of what the industry has to offer without taking too much of a risk with the design and colour, to the point that the ultimate customer might actually choose one car against another simply because they do not like the design or colour of the trim material.

Various ways have been devised to deal with this: customer clinics, either national or international can provide a general sampling view as to the suitability of the interior for a particular model from a cross-section of the public. Campaign (i.e. special limited edition) models can be used to test the market although they tend to be used for pushing out the design barriers rather than trying to weed out unpopular designs. The advent of advanced CAD now enables car showrooms to show what different materials will look like and offer options at the point of sale. Unfortunately, apart from the logistical issues which are raised, and have to be paid for

somehow, there is still no guarantee that the customer will like their own choice when it is delivered any more than they may like their new carpet after it has been fitted. The apparel and home-furnishing sectors of the market have for many years used store trials to test new designs, furniture, clothes etc., and this really does put the concepts before 'real' people who spend (or don't spend) their own real money on real products. So far no real equivalent of this has been found for the OEM.

The challenge is to create a system which can test the market as it were 'in real time' before committing to huge investment in production. This is a significant problem for all involved in the industry, particularly those who spend their lives designing fabrics because it means that the ultimate product frequently does not reflect either the technological development nor the design and colouration skills which go into its production – in other words the textile product frequently could be considered to be designed to offend the fewest people rather than to excite the most. One of the major complaints raised by almost all textile designers is the gradual 'dumbing down' of the original idea in terms of both colour and aesthetic effect as it progresses through the automotive development process. The statement is often made that no matter what colour created the initial excitement and interest it will eventually end up as some shade of grey or blue by the time it gets into the vehicle!

However the progress made over the past 20 years or so indicates that the situation is changing and at last the industry may be taking on board the need to experiment and really make use of the design potential offered now by many of the available fabric-producing technologies.

### 2.1.7 The creative issue

One area which is still a problem for both a buyer and supplier is an understanding of what they are dealing with and what is required. This issue particularly affects those dealing with aesthetic and technical design and development in both the car company and the textile supplier. The automotive manufacturers do not have a detailed background knowledge of textile production and technology, similarly neither do the textile producers necessarily have a detailed knowledge of what is involved in the production of seat and door panels etc.

Joint project meetings are held to overcome this problem but cultural and language difficulties often cloud the issues and lead to misunderstandings which can be aggravated further by subtle differences in how test procedures are performed in different laboratories. Thousands of pounds are often spent on issues as simple as how to mount a sample in a holder prior to a test. That such events should not really happen in a highly developed technical industry does not alter the fact that they sometimes do!

The differing ways in which we see colour, and subjectively judge surface pattern are problems particularly relevant to the designer. These issues of 'understanding' can compound development time and costs enormously particularly when decisions have to be delegated. For this reason it is worth spending the time at the start of projects to clarify exactly what is required and what outcome is expected or visualized. It is, in fact, the objective of this book to try and add to the pool of knowledge on both sides of the equation which will help those involved appreciate the importance of defining more closely the issues, the technological constraints and the actions required to deal with them.

Many innovative ways have and continue to be tried of making subjective decisions more objective but efficient ways of transmitting design ideas elude most companies. The age old notion of: 'I'll know it's right when I see it' still dominates most discussions concerning conceptual thoughts about what is and what is not required for a particular project in terms of surface pattern, colour combinations and even differing fabric technologies. This is one of the main reasons why those involved in devising and applying quality systems find such difficulty in coming to terms with 'design'. Creative thought processes come in an infinite variety, totally unique to the imagination of the individuals involved. Attempts to organize these creative elements into boxes or along tight procedural lines will, if taken too far, always have the end result of 'dumbing down' the creativity of first individuals then whole departments. Ultimately this can affect the reputation of whole companies, who could finish up having to copy, albeit very efficiently and to high quality standards, other companies' creative ideas instead of producing their own – a situation which quickly hits bottom lines in terms of attainable sales prices. Under these conditions it is not hard to appreciate the difficulties involved in transmitting creativity between individuals, departments and companies. Frequently the more people involved in the decision-making process the more complex and protracted it becomes.

This situation makes it essential that the supplier or designer has access to facilities which can short-circuit the problem of showing options, modifications, changes of direction etc. Efficient CAD systems can and do help but often there is no substitute for showing actual fabric samples, particularly when the customer may have several people involved in the selection process, some of whom will inevitably have difficulties in translating computer simulations into thoughts about real fabrics. It is here that quick and efficient sampling or pilot production facilities prove invaluable in shortening development lead times and helping the understanding processes. Without such facilities the designer and the customer quickly become disillusioned and cease to be effective contributors to the whole process. Sales are inevitably lost and very soon the heavy cost of providing the facilities are dwarfed by the costs of not providing them.

## 2.1.8 The choice – what technologies are available and what can they offer?

The possibilities offered to the designer of the interior have been referred to earlier and a more detailed study of the various technologies is dealt with in Chapter 3, but it is probably appropriate to consider what they offer in terms of design potential both to the textile designer and to the automotive stylist.

### 2.1.8.1 *Flat-woven structures*

The main fact to bear in mind is that flat-woven cloths are, by their structure, rigid or semi-rigid and any substantial degree of stretch has to be a function of the yarn rather than the fabric. This is an important factor for the engineer and designer to appreciate and build in to any development programme. However, it is a highly adaptable technology when it comes to the choice of raw materials, and by using flock or chenille yarns can in fact create a form of pile structure.

Add to this the patterning potential of the jacquard loom and it becomes probably the most creative technology for interior trim materials from both the design and aesthetic aspects for both engineer and fabric designer.

### 2.1.8.2 *Pile woven*

This refers essentially to double plush and is a flat-woven ground structure with a vertical pile added. The ground structure is rarely seen so serves as base for the pile which supplies all the aesthetic and surface pattern. Fairly flexible in terms of yarns but rather more restrictive than true flat woven; the fact that all visible yarns are viewed on the cross-section rather than along the periphery means that the opportunities for showing yarn characteristics is much more limited. Jacquard velvet offers similar scope for surface pattern and colour variations. The comments regarding the introduction of stretch are basically similar to flat woven.

### 2.1.8.3 *Warp knit tricot*

This technology offers limited opportunity for surface design and the exploitation of yarn characteristics due partly to the requirement to meet specification and partly due to the limitations imposed by the machines, so the designer has to concentrate on subtle variations in yarn lustres, filament cross-sections and mixtures which show up during the finishing or dyeing process. Patterning possibilities are dictated by the number of guide bars used but even in a four-bar machine (usually considered the maximum) the

restricted sideways movement means that designs are limited to small repeat geometric styles.

Dyeing and finishing, particularly brushing and other surface-active processes, play an important part in the creation of new fabrics. Developments in this area have produced dense high pile structures known as 'full rip' cloths where a dense surface has been repeatedly raised and brushed to create a very effective pile. It is a highly specialized finishing technique which has found a significant market.

The input of the designer for these types of structures is more as a technician rather than creative artist.

Warp knit by its fabric geometry offers greater stretch than flat woven without the use of stretch yarns. The structure offers a good base for printing.

#### 2.1.8.4 *Warp-knit raschel*

A highly versatile method of fabric production which has seen greatest application in automotive trim as a pile structure is known as double needle bar Raschel or DNBR, produced as a plain or semi plain pile structure for both seat inserts and bolster areas.

In this form it has greater limitations than woven velvet in the yarns it can use but has the advantage of being a more efficient and cheaper production route due mainly to operating speeds. Surface patterning is limited.

It has the advantage in the plain or semi-plain form of offering a good base for printing particularly via the newer ink-jet technology. In terms of development the designer has to look more at subtle yarn characteristics paying particular attention to the cross-sectional aspects of the yarn such as filament denier, profile and lustre variants etc.

#### 2.1.8.5 *Weft knit – flat bed*

The versatility that this technology offers the designer, rivals, or even surpasses the weaving route. Yarns of widely different characteristics can be used and are viewed along the axis so their full effect is seen. Chenille, flock and fine boucle yarns are possible in order to create surface interest and the knitting of coloured yarns can, like colour weaving, create innumerable colour and design options particularly when combined with jacquard patterning. Air textured yarns can be developed both for weaving and flatbed allowing fabrics with very high abrasion resistance to be produced.

Three-dimensional effects are attainable and surface patterns which coincide with the panel shape are also possible [see Section 3.5].

By comparison with flat wovens the fabric geometry can create flexibility and stretch potential. Overall, for the designer, it offers great poten-

tial but as yet has not made any lasting impact on the automotive trim market.

#### 2.1.8.6 *Weft knit – circular*

Circular knit fabrics can be produced as jacquard-designed structures offering wide surface pattern potential. This is a highly versatile medium and has had a big impact on the trim market particularly in Europe.

Single jersey jacquards are relatively cheap in comparison and offer good design possibilities which have been exploited in France and Italy. Yarn selection has to be carefully considered due to the critical nature of the knitting process and yarns of uneven surface profiles (i.e. boucles etc.) are not to be recommended.

The major development of recent years has been in the circular-knitted jacquard pile fabrics described in Section 3.4. They offer quite luxurious pile together with very versatile patterning possibilities capable of utilizing several yarn colours for the creation of multicoloured designs and a fabric which has inherent stretch. Despite the fact that the structure is under price pressure in competition with jacquard flat wovens it offers wide design possibilities for the designer, although again yarn selection is limited to fine counts with aesthetic differences being obtained by attention to fibre cross-section, variations in texturizing processes to create high/low surface effects and lustre variants.

#### 2.1.8.7 *Print*

In Europe, printed fabrics have not enjoyed any great success unlike Japan and Korea where they have taken a large percentage of the market. The new non-contact ink-jet printing process could change this situation and designers should acquaint themselves with this technology (described in Section 4.3).

The potential is huge in that almost any substrate described earlier could be printed via this route thus allowing the fabric and the design to be considered as two entirely separate design operations. There is only one company world-wide, at the time of writing, that is producing automotive fabrics in volume via this route so it has to be considered as an evolving technology. However, since it is essentially a computer-based technology coming from the graphics industry rather than a traditional textile technology the rate of development will be rapid particularly if one of the major printer manufacturers such as Hewlett Packard decides to target the textile area. For a designer it has to be a case of 'watch this space'.

### 2.1.9 Realizing the ideas

Eventually after all the design and development work has been completed to the time scales agreed for the project, the success or otherwise of the way in which the original idea or concept for the completed interior has been interpreted will be assessed, first of all by the managers or designers involved in the individual products and finally by the director responsible for whole interior design element of the vehicle. This is the coming together of all the various elements which constitute the interior trim – it is of course a feature of the textile trim material that, along probably with seat and fascia design, it is the main element which the final customer will see when buying and examining a new purchase, and for this reason first impressions are extremely important. Once the customer has accepted the appearance of the trim fabric he or she will in all probability have difficulty in remembering much about it thereafter.

For this reason, it is important not to convey a negative impression with the textile designs but rather to complement not overpower the whole interior ‘atmosphere’ which has taken so long to create. This is a difficult and often delicate line for the fabric designer to tread because they have to create something which has a feeling of being unique but not too unique, adventurous but not too adventurous and if possible something which carries their own ideas and handwriting but which the automotive stylist can put forward as conveying their concept as well. There is always the constant danger, as mentioned before, of designs being ‘dumbed down’ to offend the fewest rather than excite the most. The importance of treading this line carefully and successfully cannot be overestimated for the textile producer. Some designers are extremely creative but have difficulty translating another designer’s concepts into successful designs. Other designers are extremely good at translating ideas but have difficulty in imparting flair and creativity to this translation.

It can be seen therefore that if the textile producer takes either situation to the extreme it can result in failure to successfully complete the project. Carefully selecting designers to major on their strong points must be a priority for the textile trim manufacturer – reputations, good or bad, tend to last a long time in the automotive business. A flair for colouration is also an extremely large part of design development – designs can be transformed by clever use of colour and colour combinations within the textile fabric, and the modern use of coloured yarns prevalent, particularly in Europe, makes this aspect of the utmost importance.

Unfortunately the trend of automotive companies to frequently insist that the majority colour of trim fabric must match some interior trim shade most usually the vinyl or fascia colour which in turn is usually a rather unex-

citing variation on shades of black, grey or blue, mitigates against the intelligent use of colour in the fabric and it is often this situation which drives the use of either toning self colours or highlight colours on dark or predetermined backgrounds. It is not unknown for the exact non-metameric colour-matching of a vinyl shade onto a polyester yarn to take almost as long as the development of the design itself – not a situation which encourages creative textile design.

The situation is one, however, which the interior trim designer has to live and work with and it is a tribute to the design and colouration ingenuity which modern technology and clever designers have exploited that, despite the criticisms mentioned earlier, today's car interiors are infinitely more attractive in every way than even a decade ago. It is important however to emphasize that today's dyes, fibres, yarns, fabric technologies, finishing techniques and production techniques all offer an almost infinite range of possibilities in terms of creative design and colouration. Design in all its aspects does now and will, due to world overproduction of cars, continue to play an increasingly vital role in maintaining market share.

It would be wrong at this stage in the discussion about fabric design not to mention the important influence that the established fabric testing procedures operated by the OEMs have on the creativity of the designer. It is a fact of life that in most car companies the role and responsibility of the designer and that of the laboratory manager are separate and, it often appears, non-complementary. Most companies now employ textile designers in their trim design areas but few companies probably realize at a higher management level the dramatic effect the imposition of stringent test procedures has on their fabric-design options.

A textile supplier who may supply numerous OEMs will have to develop light flat wovens and heavy pile fabrics for company A, while exactly the reverse can be the case with company B. There cannot be many sound technical reasons for this when all manufacturers are selling predominantly into the same world market place, and the most likely explanation is historic. In today's design-led environment a very strong case can be made for thorough reviews of testing procedures to assess their real relevance in the light of many years of experience of using textile fabrics in cars. Relaxation or even minor changes to tests and assessment procedures can open up whole new fields of creativity and design possibilities for those responsible for the development of interior trim textiles.

### 2.1.10 Summary

The main requirements for any manufacturer who is contemplating moving into the automotive textile trim field can be summarized as follows.

Be prepared for high entry costs in terms of both money and time to market.

Invest in good quality designers and research the local market thoroughly. Become involved in the design education process.

Be prepared to invest in several fabric-producing technologies and establish pilot plant production for design and development, if possible in each one.

CAD is essential and is often composed of two parts – a creative package to cover all technologies, these specialist creative design packages are available from most textile CAD suppliers – or the ubiquitous Adobe Photo shop package, which can be used very successfully as a more general creative tool.

In addition specialist targeted CAD packages related to the individual technology are also essential for the quick translation of creative ideas into design repeats and ultimately the fabric itself.

Research the availability of suitable raw materials and establish whether they can be supplied to the the high requirements of the automotive business.

Institute quality and auditing procedures to verify suppliers before investing large amounts of money in trials.

Become familiar with the physical test requirements and be prepared to invest in expensive fabric-testing equipment including lightfastness.

Establish test procedures alongside the development process and educate designers in the fabric requirements.

It is up to the managers, designers and technologists of both the OEMs and the textile suppliers to ensure that the possibilities offered by today's textile technology and the design flair of the fabric designers, which the UK universities lead the world in educating, are not wasted due to lack of imagination and forward thinking on the part of those responsible for creating, developing and specifying interior-design concepts.

## 2.2 Further reading

1. Aldrich WE, 'CAD in Clothing and Textiles', Oxford, BSP Professional Books, 1992.
2. Anon, 'Strong stuff needed for the road ahead', *International Dyer*, July 1999, 19–21.
3. Anon (material from DRA Associates), 'Car seating fabrics – suppliers and trends', *Automotive Seating Review 1997 (Inside Automotives International)*, 1997, 28–37.
4. Fabris G, 'The Maher Lecture: an analysis of social change and its effect on the world of textiles and fashion', *J Textile Institute*, 1988, 1–13.
5. Hann MA & Thomson GM, 'The Geometry of Repeating Patterns', Manchester, The Textile Institute, 1992.

6. Higginson S, '*World Review of Textile Design*', Manchester, The Textile Institute, 1993.
7. Grosicki ZJ, '*Watson's Advanced Textile Design*', 4th edn London, Newnes-Butterworths, 1989.
8. Goerner D, '*Woven Structure and Design Pts 1 & 2*', BTTG/WIRA, Leeds, 1989.
9. McGarrigle J, (Ciba), 'Upholstery colour and design – meeting the demands of the market', *Automotive Interiors International Directory 1997*, 4–8.
10. McNamara A & Snelling P, '*Design and Practice for Printed Textiles*', Australia, OUP, 1995.
11. Meller S & Elffers J, '*Textile Design*', London, Thames & Hudson, 1991.
12. Phillips P & Bunce G, '*Repeat Patterns; A Manual for Designers, Artists and Architects*', London, Thames & Hudson, 1992.
13. Schoeser M, '*International Textile Design*', London, Laurence King, 1995.
14. Ten Hoeval B, 'Worldwide trends in automotive textiles', *Automotive Interiors International Directory*, 1996, 16–18.
15. '*The Surface Designer's Art*', North Carolina, USA, Lark Books, 1993.
16. Whelan BM, '*Colour Harmony*', London, Thames & Hudson, 1994.
17. Waterson J, 'Covering trends', *Automotive Interiors International*, February 1998, 28–32.
18. Waterson J, 'Global trends in colour trim', *Automotive Interiors International Directory 1997*, 10–20.
19. Yates M, '*Textiles; A Handbook for Designers*', 2nd edn., London & New York, Edn Nortons, 1995.

### 3.1 Introduction, fibres and yarn types

The use of textile products for the trim areas of vehicles has a relatively recent history when compared with other more established sectors of the decorative textiles industry.

The high technical requirements that the automotive industry places on all items which go into vehicles has ensured that many of the old-established methods of producing fibres, yarns and fabrics proved to be at best extremely difficult and at worst virtually impossible for many reasons, among the most important of these are;

Abrasion,	Fastness to light and UV degradation,
Tensile strength,	Pilling,
Flammability,	Seam strength.

Although many tests are required by OEMs before a fabric is signed off as acceptable, it was the reaction to these tests which proved instrumental, almost by a process of natural selection, in identifying the most suitable fabric technologies, and in quantifying polyester as the most universally acceptable fibre for automotive trim fabric. In selective tests other fibres, particularly nylon for strength and elasticity, acrylic for lightfastness, and polypropylene for strength for minimum weight, can each outperform polyester but none can perform as consistently well across all the tests.

The fact that polyester has become a world fibre in the truest sense means that it is now virtually universally available no matter where the fabric manufacturing takes place. Intense research into new variants of polyester to achieve specific results such as stretch, variable dyeing, different lustres, and colour extrusion of the polyester filaments, has contributed to consolidate its position as the dominant fibre for automotive decorative trim fabrics. In 1997 polyester gained the distinction of achieving a 94% world market share of automotive textile trim fabrics and as at the time of writing, there

seems to be little in the way of serious competition to radically change that situation in the foreseeable future. However the choice of polyester is but the first link in the chain, yarn production systems, and fabric technologies play an equally important part.

### 3.1.1 Fibres

The use of natural fibres in the production of textile materials for automotive interiors is limited in the main to wool, due to minimum performance requirements for lightfastness, abrasion etc but also due to the comfort and added value which wool is perceived as imparting to the product. It has been the introduction of synthetic fibres which led to the growth in products which found their way into automotive end uses for reasons mainly to do with performance, cost and versatility.

Synthetic fibres are always produced in a continuous filament form which can be retained as continuous filament in producing textured yarns or cut into short lengths, known as 'staple', for blending with natural fibres such as wool and spinning on the conventional systems such as ring or open end which we shall describe later. Most synthetic fibres and yarns and certainly the ones used in automotive fabrics are thermoplastic in nature. This is an important property of synthetic fibres particularly when texturized yarns and fabrics are being produced. Essentially it is the ability of the fibre, yarn and eventually the fabric, to be set without causing a chemical change, in various conditions by the application of heat on a time/temperature basis. In very broad terms what has been set into the fibre during manufacture will be permanent unless the time and temperature is exceeded in subsequent processing at which point a new overriding 'set' is introduced. [This process is fundamentally different from the crease-resist processes which are applied to cellulosic fibres and fabrics where a chemical cross-linking of the fibre molecules takes place.] This property is often referred to as the 'heat memory' of the fibre.

### 3.1.2 Partially orientated yarn

When synthetic fibres are being manufactured the molten polymer solution is extruded through a spinneret which is a series of fine holes in a plate, the size, shape and number of the holes determining the decitex, fibre cross-section and number of filaments in the yarn being produced. The filaments are gathered together, dried in an airflow and wound onto a producer bobbin for the next stage. It is necessary during some stage in the process to 'draw' the fibres. This process refers to the stretching of the individual filaments to orientate the molecules, which in turn strengthens the fibres and reduces to acceptable levels the further tendency to stretch.

It has been found that part of this drawing process can be carried out during downstream operations such as texturizing [air or false twist known as draw texturing] or warping [known as draw warping]; this speeds up the production of the original fibres and is commercially attractive for this reason.

It also has technical advantages since yarns can be produced with specific amounts of residual stretch left in by adjusting the draw ratios during texturing and for automotive use, particularly in fairly rigid flat-woven cloths, partially orientated yarns can produce cloths which are capable of being moulded under pressure to three-dimensional shapes such as door panels or head shells.

### 3.1.3 Heat history

During the manufacturing processes from fibre through yarn, fabric and finally into a finished product a 'heat history' is acquired and a close study of this can often provide useful information, for instance in the designing of suitable downstream processes, or in developing characteristics for specific end uses, or even in finding the cause of quality problems such as dimensional changes in the fabric after manufacture, which could be either subsequent shrinkage or the opposite one of extension or 'bagging' in use. A rule to remember is that any synthetic thermoplastic fibre, yarn, or fabric will always strive to return to the form of its most permanent set [time  $\times$  temperature] wherever that occurred during the process.

Heat history of synthetic textile products can either be an extremely useful or a very dangerous property depending upon how much attention it receives during the whole manufacturing process and should never be ignored during the development processes. We have earlier referred to the dominance of polyester as a fibre for automotive textiles. This is a synthetic and has thermoplastic properties and is capable of being produced in continuous filament textured form, blended or produced as 100% in staple-spun yarns.

### 3.1.4 Yarn types

In order to produce a good-quality, well-designed, aesthetically pleasing fabric it is essential to pay particular attention to the basic building blocks of the structure and they start with the yarn. Many yarn types are used in the production of automotive fabrics and, although continuous filament false twist and continuous filament air-textured predominate, we need to have an appreciation of other possible methods to obtain a rounded view of the situation in order to make informed decisions about designing fabric

structures and also appreciate the possible problems associated with selecting the wrong route for particular fabric technologies.

### 3.1.5 Staple spinning

This is probably the oldest method of yarn production. It started as the method to consolidate discontinuous variable-length fibres, known collectively as staple, of natural products such as cotton, wool, flax, etc. into continuous lengths of yarn of known and controllable thickness designated by the 'count' or 'number' of the yarn (i.e. weight per unit length).

The method used was one of drawing out the fibres into ever more parallel sheets or strands called 'rovings'. These were then made more parallel by a process known as carding and in the case of the better quality yarns, usually produced from fibres with longer staple lengths. A further 'combing' process was included. Eventually the roving of parallel fibres was drawn out or 'drafted' to reduce the number of fibres in the cross-section and when the desired number had been achieved twist was inserted to bind all the fibres together and produce a yarn. The strength of such a yarn was highly dependent upon the amount of friction between the individual fibres – known as 'inter-fibre friction'. Up to certain points this was increased or decreased by adding or reducing the amount of twist applied at the spinning stage.

For thousands of years the whole process was done by hand until the Industrial Revolution in the mid-eighteenth century saw the introduction of mechanical means of reproducing the process, which is now referred to as 'ring spinning' on account of the ring which carries the yarn round the package as twist is inserted [see Fig. 3.1]. Other methods such as 'open-end' spinning and 'wrap spinning' are all based on forming fibres into yarns and each have their own particular characteristics. All these methods tend to reduce the amount of twist required to form a yarn, thus increasing production and reducing costs but in almost all cases also reducing the surface abrasion characteristics of the yarn. An exception to this would be the air-jet spinning technique – not to be confused with air-jet texturizing – where twist is inserted into the fibres by application of multiple air jets, and wraps fibres in opposing directions round a central core of fibres.

For automotive applications any system which reduces surface abrasion should be avoided so wrap-spun or open-end-spun yarns should be treated with caution. Ring spinning is the system which has the longest history and is tried and trusted, plus it has the advantage that abrasion properties can be improved by simply increasing the twist in the yarn at the spinning stage.

The method of forming fibres into yarns known as ring spinning started with natural fibres but now encompasses the full gamut of synthetic fibres including polyester where the continuous filaments are cut into suitable

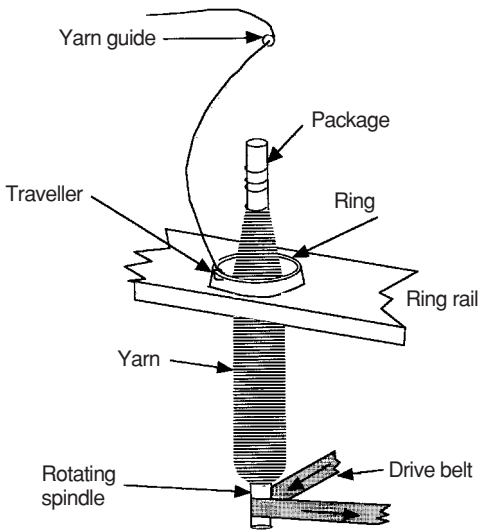

3.1 Basic elements of ring spinning.

lengths prior to the spinning process and are either spun as pure fibre or as blends with natural fibres, with polyester and wool being a favourite blend for automotive applications.

The staple length of the fibres and also the thickness and variability decide which of various systems are used – cotton system, worsted system, woollen system etc. – each creates yarns with their own characteristics and properties. There is not enough room in this book to go into detail but blended polyester and wool ring-spun yarns are used extensively in woven velvet and flat-woven automotive structures where the strength and abrasion resistance of the polyester complements the comfort and moisture-absorbing properties of the wool in a yarn which adds to the aesthetic appearance and handle of the trim fabric.

### 3.1.6 Continuous filament yarns

The advent of synthetic fibres in the middle of the twentieth century saw an explosion of new applications for textile products – replacing silk in hosiery, strengthening vehicle tyres, assisting in civil engineering projects, etc. etc. Despite these new markets however no sooner had the new synthetics started to become known in their own right than ways were investigated to make them more ‘natural’ in handle and appearance. We have described how this could be done by cutting the filaments into suitable lengths to spin and also to blend with natural fibres such as cotton and wool but how could bundles of continuous filaments be made to rival natural products?

Investigations eventually led to the creation of what we now know as 'texturizing' processes. Over the years these have become extremely versatile and effective in engineering yarns to meet specific purposes and have had a huge effect upon the development of textiles for automotive use particularly in the trim areas. Over the years many methods of texturizing yarns have been developed and most have concentrated on curling or deforming the individual filaments within the yarn and increasing the air space between the filaments to create such properties as soft handle, high bulk, warm touch, etc. Methods such as 'gear crimping', 'stuffer box crimping', 'knit de knit crimping' have all gained a place in specialized end uses. However, in automotive applications the need to meet strict performance requirements, such as abrasion and strength, has ensured that the two main methods which have survived and which are worth studying due to their success in penetrating the automotive fabric business are 'false-twist-textured' and 'air-jet-textured'

### 3.1.6.1 *False-twist texturizing*

This method uses the principle of twisting the filaments in a continuous multifilament thermoplastic yarn, thermal fixing of this twisted yarn and then untwisting at a lower temperature.

The twist which had been set into the yarn is 'false' in the sense that at no time during the texturing process is either the supply package or take-up package rotated but the individual filaments due to their heat memory try to assume the twisted dimension. This creates a bulking of the yarn as the filaments try unsuccessfully to spiral round each other.

The method of twist-insertion, heat-setting and twist-removal is a continuous process as illustrated in Fig. 3.2 reproduced by kind permission of Rieter-Scragg Ltd.

The yarn which results from this method of texturizing is characterized by high bulk where the filaments retract and distort under conditions of zero load and are pulled virtually parallel when load is applied. This lends an element of stretch or extensibility to the yarn which can, in certain circumstances, be very useful for automotive applications. In order to give some cohesion to the yarn the filaments are 'intermingled' at points along the length of the yarn by introducing jets of air during manufacture. These intermingling points, sometimes referred to as 'knots' or 'nodes', can be at almost any predetermined frequency although 100 knots or points per metre, or one every centimetre, is a fairly common standard which is applied.

The axis of the yarn in close up is shown in Fig. 3.3 and from this it can be seen that despite the intermingling points the individual filaments are highly visible and this can cause abrasion problems when the yarn is used in woven products where the filaments are easily worn away in use. Careful

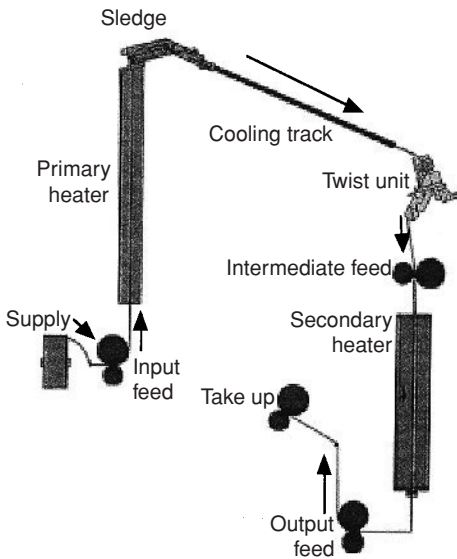

3.2 False twist texturing. (Reproduced by kind permission of Rieter-Scragg Ltd.)

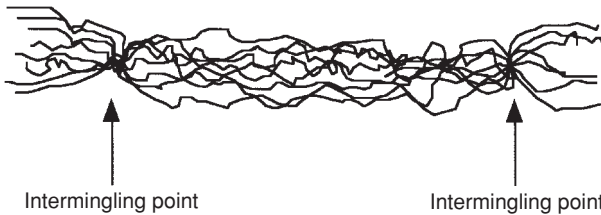

3.3 False-twist yarn in relaxed condition showing crimp developed in the individual filaments. Note that the filaments are not bound into the body of the yarn except at the intermingling points – this can cause abrasion problems if the axis of the yarn is exposed during use.

attention to fabric design and combination with other yarns, such as air-textured or staple-spun, can reduce this effect and still allow the advantages of false-twist yarns such as production efficiency, stretch and cost effectiveness to benefit the end product.

False-twist yarns however have made major contributions in automotive fabrics as the pile yarn in cut pile fabrics such as woven plush, double-needle bar, circular knit. In these cases the bulking effect is shown to best advantage when translated into pile coverage or density, and the abrasion issue is much less of a problem since it is taking place on the cross-section rather than the axis of the yarn. This invariably yields a better result even

though the test method used can have some unfortunate effects – the Martindale abrasion method for instance can show up some harsh results on cut pile fabrics unless it is subject to very careful assessment, and reliance on this method alone could lead to over-engineering the product and the cost.

False-twist yarns are produced primarily from nylon and polyester but can theoretically be produced from any strong synthetic fibre which is thermoplastic and can display heat memory. The dominance of polyester for the reasons explained at the start of this chapter continue to ensure that the majority of false-twist yarns used in automotive trim fabrics are produced from this fibre.

### 3.1.6.2 *Air texturizing*

The development of the air-texturing process for continuous filament yarns was probably one of the most significant textile processes contributing to the vastly increased use of textile fabrics in the trim area of cars. The use of polyester soon became prominent for the reasons discussed earlier but the technique of air texturing added a new technical dimension which increased the durability and quality of the fabrics, particularly flat-woven fabrics using textured yarn, and provided answers to many of the early problems of consistent quality and durability encountered with other yarn technologies.

Several flat (i.e. parallel-filament, un-textured) individual continuous filament yarns known as 'feed stock' yarns (which are likely to be partially orientated yarns as described earlier) are arranged in a creel and run together into the path of an air jet which distorts and intermingles the filaments so that, unlike false-twist yarns, they are effectively locked in position to create a composite yarn which has strength, a high degree of levelness and uniformity, and which, due to the integration of the filaments, possesses greater resistance to surface abrasion than almost any other yarn technology. The individual feed stock yarns can be introduced into the air jet at the same rate to create what is known as a parallel-textured yarn where all the feed stock yarns are textured to the same level, or they can be introduced at different rates to create what are known as core and effect yarns, which possess a higher degree of texture on the effect creating a raised surface and warmer touch in the fabric. A typical air-texturizing line is illustrated in Fig. 3.4. The differences between a parallel textured yarn and a core and effect yarn is shown in Fig. 3.5.

There are many other possible variations in the design of specific properties in air-textured yarns. These include using feed-stock yarns with different filament thickness (decitex) or lustre (bright, dull, etc.) or filaments with different cross-sections (round, tri-lobal, etc.). Another technique for automotive use is to design stretch into the yarn by using a feed-stock yarn

Textured yarn packages      Air texturizing heads      Creel of feed-stock yarn

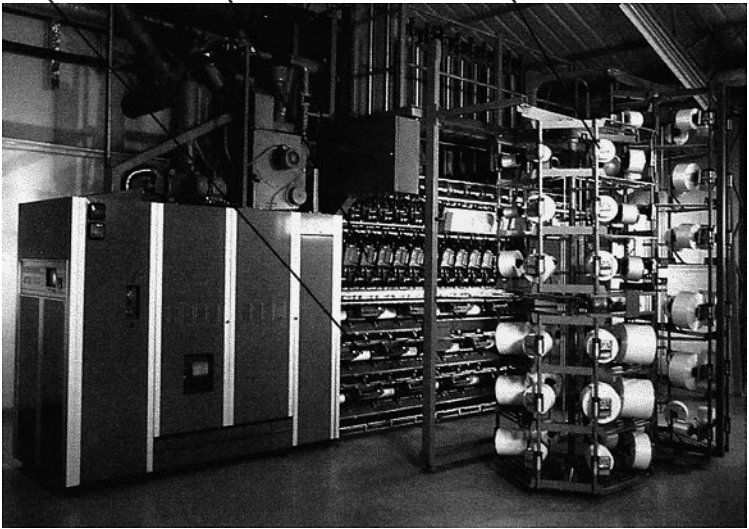

3.4 Air-jet texturizing line. (Reproduced by kind permission of Rieter-Scragg Ltd.)



Parallel-textured yarn

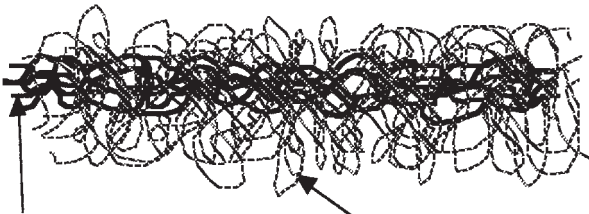

Core filaments

Effect filaments

Core and effect yarn

3.5 Comparison of parallel and core and effect air-jet textured yarns.

made from a special polyester polymer which has a certain amount of stretch and recovery 'built in'. These special polymers known as polybutylterephthalate or PBT have made major contributions in recent years in the design of woven fabrics with enough flexibility to allow the automotive interior designer greater freedom in the application of the fabrics to more adventurous three-dimensional shapes.

### 3.1.7 Speciality yarns

Although numerous novelty and speciality yarns have been developed, only a fraction of these have found their way into automotive uses, mainly due to the high specification requirements particularly abrasion, pilling, snagging, etc. However, at least two yarn types are worth discussing since they have been quite successful in automotive fabrics.

#### 3.1.7.1 *Chenille yarns*

Chenille yarns are constructed from at least two fine-core yarns woven in leno fashion or twisted together during this process. Pile yarns are inserted at right angles and cut to within 1 or 2 mm of the core yarn surface to create a surface in which the fibres contained in the pile yarns burst and form a soft pile surface to the yarn. There are two main features of this technique which cause problems for automotive use; one is the fact that due to the construction technique the pile tends to twist and flatten in different directions causing variable light reflection and the other is the tendency for the pile yarns to pull out of the core during use.

Developments of the method of construction have largely eliminated these problems; low-melt fibres have been inserted in the core which fuse with the pile under subsequent heat processes to help increase pile adhesion and clever methods of pile yarn insertion have created a more rounded yarn effect yet still retained the somewhat unique character of the chenille.

#### 3.1.7.2 *Flock yarns*

Flock yarns must not be confused with chenille since they are totally different yarns although they still present a pile surface. They have been used extensively in automotive applications due to their high abrasion resistance and versatility. They are constructed from pre-cut pile fibres which are only 1 or 2 mm in length and which are electrically charged and deposited upon a core yarn which has been pre-coated with an adhesive. Opposite electric charges ensure that the fibres are attracted to the core in a vertical position and are fixed in this position by the adhesive. This method means that when the pile is deformed in use the fibres have to bend easily or they will break

causing uneven wear and it is this feature which has led to the use of nylon as the pile fibre rather than polyester which has a much more brittle and less flexible character than nylon. Viscose has been used successfully as a core due to the affinity with the adhesive to give good adhesion to the pile.

Loss of pile in extended use with flock yarns is much less likely than with the chenille yarns in similar fabric constructions although the fabrics tend to be harsher and less flexible.

The differences in yarn profiles can be clearly seen in Fig. 3.6.

### 3.1.8 Yarn thickness or 'count'

The thickness or weight of yarns is measured by calculating the weight per unit length. There are dozens of different methods of doing this but generally all continuous filament textured yarns are designated by their 'Decitex' which is a direct system of measurement – the higher the number of the Decitex the thicker the yarn. The Decitex is the weight in grams of 10000m of the yarn, 10000m of an 830 decitex yarn weighs 830g. (Incidentally the forerunner of Decitex was Denier most often associated with nylon hose. Denier was and still is the weight in grams of 9000m of yarn.)

Staple-spun yarns use an indirect system in that the greater the number of the count and the thinner or lighter the yarn, the count is calculated according to the spinning system used (i.e. cotton-spun – cotton count or cc or Ne; worsted system used for wool uses the worsted count or wc. Linen system linen count or lea). In Europe attempts at standardizing the situation has led to a metric count to cover all systems. Whatever system is stated, it always is based on the weight in pounds or kilograms of a certain stated length of yarn.

The table in Fig. 3.7 gives a clearer understanding of what can be a confusing situation. Proper consideration of the count of the yarn is vital in designing suitable fabrics for automotive and, in fact, any other use since it is the building block on which all subsequent properties are based.

## 3.2 Fabric structures – wovens

Automotive textile manufacture is somewhat unique in that it requires the producer to be competent, if not expert, in several textile fabric technologies all at the same time. Traditionally this has not been the way in which most textile companies have developed. Usually it has been a case of concentrating investment and expertise in maybe one technology and concentrating effort in locating different markets for essentially the same product technology. Where possible, additional investment would be channelled into upstream or downstream activities which would support this original technology. Even large multinational companies which had acquired many

Twisted core holding pile

Pile fibres held by core

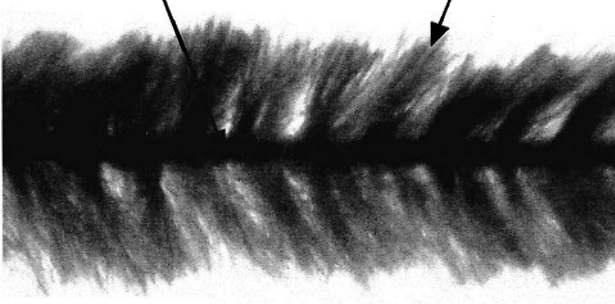

Chenille yarn

Core covered with adhesive to hold pile vertically

Pile fibres glued to core

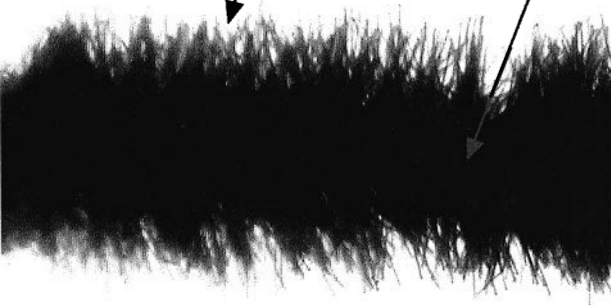

Flock yarn

### 3.6 Comparison of surface profile of chenille and flock yarns.

fabric manufacturing technologies would effectively differentiate between them by placing them in different divisions with separate profit centres.

The requirements of the automotive companies turned this well-established concept on its head. Their need was for one company serving one end use with as many technologies as could meet the demanding

		Direct count systems
		[The higher the count number the thicker/heavier the yarn]
TEX	[Tex]	Weight in grams of 1000m of yarn
DECITEX	[Dtx]	Weight in grams of 10000m of yarn
DENIER	[Den]	Weight in grams of 9000m of yarn

		Indirect count systems
		[The higher the number the thinner/lighter the yarn]
METRIC	[Nm]	Number of 1000m hanks of yarn per 1 kilogram
COTTON	[Ne <sub>c</sub> ]	Number of 840 yard hanks per 1 pound weight
WORSTED	[Ne <sub>w</sub> ]	Number of 560 yard hanks per 1 pound weight
WOOLLEN	[Ny]	Number of 256 yard hanks per 1 pound weight
[Yorkshire]		
WOOLLEN	[Nar]	Number of 1600 yard hanks per 1 pound weight
[American]		
LINEN	[Ne <sub>l</sub> ]	Number of 300 yard hanks per 1 pound weight

### 3.7 The major direct and indirect yarn count numbering systems in use.

technical requirements. This led over a period of several years to the establishment of single companies dedicated to serving the automotive producer with flat wovens, warp knits, circular knits, prints, non-wovens, each in a variety of effects achieved through the finishing processes. The technical strains this placed upon management have been considerable and in many cases led to the creation of joint ventures or technical agreements between manufacturers although the strong textile producers in the field nowadays have faced up to the responsibility of coming to terms with all these various fabric production technologies and their up- and downstream requirements in terms of raw material and finishing. During the course of this chapter we shall be looking at the main fabrics in use in the automotive industry but before that, it is important to have an appreciation of the fibre types and yarn production methods which have developed and the reason why they have developed to support the successful fabric technologies.

The three main fabric-forming structures which have a place in automotive manufacturing are woven, knitted and non-woven. Each of these can be divided into a multitude of additional classifications each with its own particular technology or technique; broadly speaking woven structures have a base of two sets of interlacing threads at right angles to each other; knitted structures have a base of many individual interlacing threads at a variety of angles to each other and non-woven structures are based on textile structures produced directly from fibres rather than yarn and utilize some bonding or needling process. They are dealt with separately in Section 3.6.

In both the woven and knitted sections true pile fabrics are included which utilize the same base but have an additional dimension of pile which stands out vertically or semi-vertically from the two-dimensional base and these are discussed under woven velvet and weft knitting.

### 3.2.1 Woven structures

The woven fabric is the original textile structure and is formed by the interlacing of two sets of yarns.

The properties of woven structures are determined by three main elements:

- 1 Yarn properties in terms of thickness, surface characteristics, fibre content, strength, extensibility etc.
- 2 Fabric setting or the density in which the yarns are woven, usually referred to as the threads per inch or per centimetre
- 3 The method of interlacing of the yarns known as the weave of the fabric

By varying the above three elements an infinite number of fabric variations can be created in terms of physical, chemical or aesthetic properties as well as an equally vast range of surface design and colour options. It is this huge potential in terms of design and physical possibilities which has been instrumental in making woven structures a dominant force in automotive trim over the past 20 years or so. In more recent times however one of the features of woven structures – their tendency to be rigid in both directions – has mitigated against their use in the more adventurous trim and seating designs where the ability to stretch round corners has been an increasing requirement. The use of stretch yarns and special finishing techniques has helped but not totally solved this problem.

Woven fabrics can be further subdivided into flat woven and pile woven. Flat-woven structures are essentially two-dimensional whereas pile woven use the two-dimensional flat woven as a base upon which vertical pile yarns are incorporated to create a more three-dimensional velvet or plush effect.

#### 3.2.1.1 Flat woven

Flat-woven structures are composed of two sets of individual threads interlaced at right angles to each other. The vertical threads are collectively referred to as ‘warp’ or individually as ‘ends’ and the horizontal threads are collectively referred to as ‘weft’ or individually as ‘picks’. In the USA weft is referred to as ‘filling’.

The interlacing of warp and weft is done by separating the individual warp threads across the full width of the fabric to create an opening or ‘shed’ through which the weft thread is inserted. This shed is then closed

and the weft thread compacted or 'beaten up' to the preceding weft thread before another shed is formed separating different combinations of warp threads – and so the process is repeated at up to 1000 times a minute or more in the fast air-jet weaving machines. The method used to control the individual warp threads to create the shed determines the potential of the process to create simple or complex weaves and surface patterns.

The two main classifications of weaving machines are 'dobby looms' and 'jacquard looms' both use exactly the same principle of interlacing vertical warp threads with horizontal weft threads but the control mechanism for the process is totally different and accounts for the greater versatility of jacquard looms in the production of figured fabrics and designs. Dobby looms use individual 'shafts' which have the limitation of controlling warp threads in groups whereas jacquard looms have much greater versatility in that they control a far greater number of threads individually by the use of a 'harness' arrangement.

The weaving process is carried out on a loom which requires a prepared sheet of individual warp threads or ends to be entered into either a set of shafts in the case of the dobby looms or into the harness in the case of the jacquard looms. In both cases the shafts or the harness control the individual warp threads or ends and allow the weft threads or filling to be inserted to create the weave and thereby the woven structure.

Figure 3.8 shows the basic woven structure and how the warp and weft threads interlace, it also shows how yarn crimp is introduced due to this process. The control and manipulation of this physical characteristic of woven cloths is an often misunderstood and overlooked element which can add or subtract from the required cloth performance.

Many different manufacturers produce machinery for the production of woven cloths and there are several different ways in which the weft threads can be inserted – by the traditional shuttle or by the more recent rapier

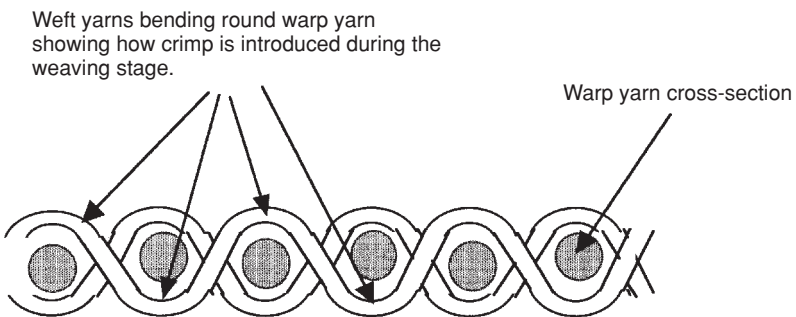

3.8 Cross-section of a plain-weave structure showing how the yarns interlace and 'crimp up'.

principle which can be either rigid or flexible, by individual 'bullets' as in projectile weaving, by compressed air as in air-jet weaving and also by jets of water in water-jet looms. The speed with which the insertion of the weft threads can be carried out determines the fabric production speed and thereby the production costs.

Each method has advantages and disadvantages and usually is suited to a particular range of yarns and fabric types.

The main essential processes involved in the production of woven fabrics, either flat or pile, are: yarn preparation; warping; production of the warp beam for the loom; entering the warp into the loom; weaving; checking all elements against approved masters; doffing the woven pieces; finishing (to include coating laminating etc.).

### 3.2.1.2 *Warping*

As in all things careful attention to the preparation of the raw material is a prerequisite to producing a good quality product and this is never more true than the preparation of the warp prior to the weaving process. This requires a creel in which all the individual yarn packages are mounted and drawn together as a section to be wound on to the drum.

The warp contains all the individual threads or ends which are used in the full width of the fabric, these threads are wound side by side onto a beam as a continuous sheet which can be up to 3000 m or more long dependent upon the count and density in ends per cm of the yarn being processed. Various methods are employed to do this but the one which best combines quality, production efficiency and pattern versatility is the section-warping system in which the warp sheet is built up in sections across the width of a large diameter drum until the full length and number of ends is completed. This is then transferred from the drum onto the weaver's beam used in the loom. One of the leading producers of section-warping machinery is the Benninger company of Switzerland and the process is illustrated in Fig. 3.9 and 3.10.

The modern section-warping machine is effectively under computer control with continuous control of yarn tension during all production phases, and the all important control of the correct build-up of the individual yarn sections across the width of the large drum which is so vital to the production of high quality warps which form one of the building blocks for successful fabric production.

### 3.2.2 Weaving – flat fabrics

The process of creating fabric from the warp is carried out on a loom which mechanically interlaces the individual vertical warp threads with the hori-

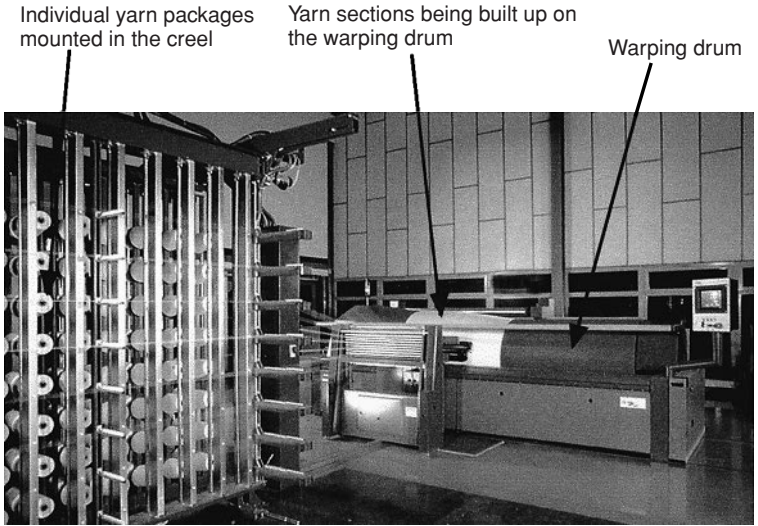

3.9 Section-warping machine. (Reproduced by kind permission of Benninger Co Ltd. Switzerland.)

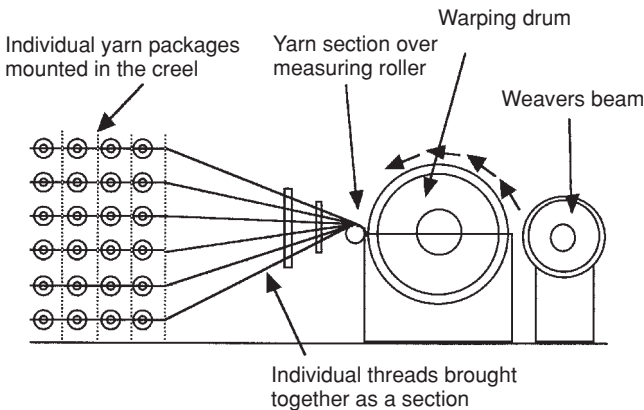

3.10 Diagram of section warping machine. (Reproduced by kind permission of Benninger & Co Ltd. Switzerland.)

zontal weft yarn. The way in which this interlacing is done determines the weave and surface design of the fabric. An individual warp end can only be in one of two positions in relation to the weft thread – it can either be over the weft or under and it is this ‘over’ and ‘under’ position of each of the ends across the full width and length of the fabric that determines the weave of the cloth and also the surface design or pattern. This weave can be illustrated on squared paper known universally as ‘point paper’ where a square

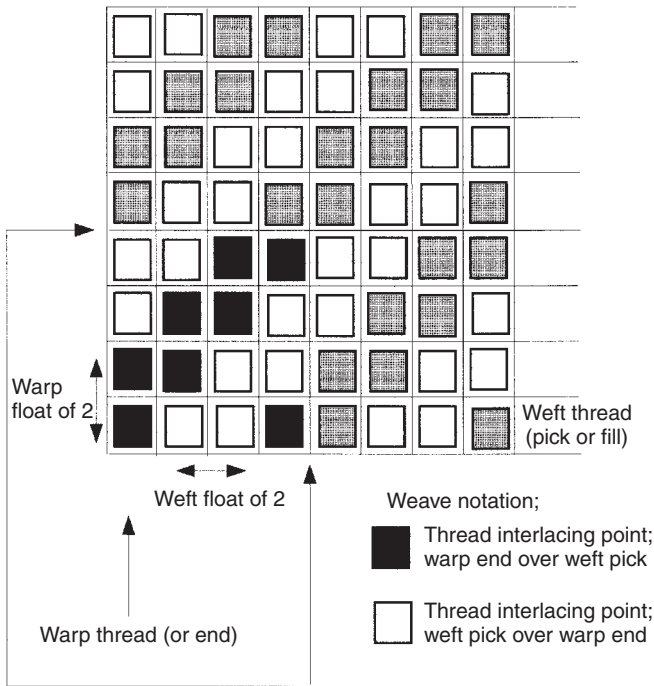

This indicates 1 repeat of the weave, i.e.  
4 picks  $\times$  4 ends

3.11 Point paper notation of  $2 \times 2$  twill weave.

filled in represents a warp thread (end) over a weft thread (pick or filling) and a blank represents a weft thread over a warp thread. Where a thread goes over another thread the result is known as a 'float' so that if a warp end goes over two adjacent weft picks it is referred to as a warp float of two and where the reverse applies it would be known as a weft float of two. Where this is done however it is important to define whether the float is on the face or the back of the fabric.

All weaves have a repeat, in other words the interlacing pattern starts repeating after a certain number of ends and picks. Figure 3.11 illustrates a very common weave known as  $2 \times 2$  twill since it is formed by ends floating over a group of two picks and vice versa. Twill weaves such as this create diagonal lines in the fabric, the angle of the twill is determined by the relationship of the number of ends per inch to the number of picks per inch. In a 'square set' fabric these are equal and the angle would be  $45^\circ$ .

A weaving machine performs three main elements mechanically:

- 1 It controls the way in which the warp ends interlace with the picks, this determines the weave and surface pattern of the fabric.

- 2 It controls the amount of warp that is advanced or 'let off' after each weft thread has been inserted, this is a major contributor to the fabric density by controlling the picks per cm (or inch) in the cloth. The lower the advance after each pick the higher will be the picks per inch, the higher the fabric density, the lower the production rate of the cloth and the higher the overall cost to produce each metre or yard of fabric.
- 3 It controls the insertion of the weft yarn into the fabric and the speed at which this is carried out directly determines the production rate of the cloth and is therefore responsible for one of the main production cost elements of the fabric.

There are two main methods of controlling the individual warp ends – by shafts in dobby-woven fabrics and by harness cords in jacquard-woven cloths. Jacquard-woven fabrics have a far greater potential for surface pattern creation than dobby which tend to be limited to plain, semi-plain weave effects or geometric-style patterns. The visual effect of both can be increased by the use of coloured yarns in stripe and check formation and it is the combination of yarn selection, colour selection, weave creation and design or pattern production which is the preserve of the highly skilled woven textile designer.

### 3.2.2.1 *Dobby weaving*

In dobby production the individual ends of the warp are entered through mail eyes which are mounted on frameworks or shafts which traverse the full width of the cloth. Each shaft can lift or lower all the ends it controls over or under each pick as they are inserted but since the number of individual shafts which can be accommodated in a loom is limited (16 is common but above 20 is more difficult and can reduce weaving speeds and efficiencies) it follows that the possible combinations of thread interlacing are also limited so that the figuring capacity to produce complex patterns is much less than with a jacquard machine. The figuring capability can be increased by carefully deciding the order in which the ends are arranged through the mails and on the shafts – this is known as 'drafting' and is yet another skilled operation worked out by the textile designer when creating the fabric and design.

Figure 3.12 illustrates the arrangement for a simple four-shaft style which could be used to produce the  $2 \times 2$  twill weave. The drafting arrangement or 'draft' is noted on point paper in a similar way to the weave.

### 3.2.2.2 *Jacquard weaving*

In jacquard-woven cloths each individual end in the repeat of the design is controlled separately by a harness cord which is in turn controlled by the

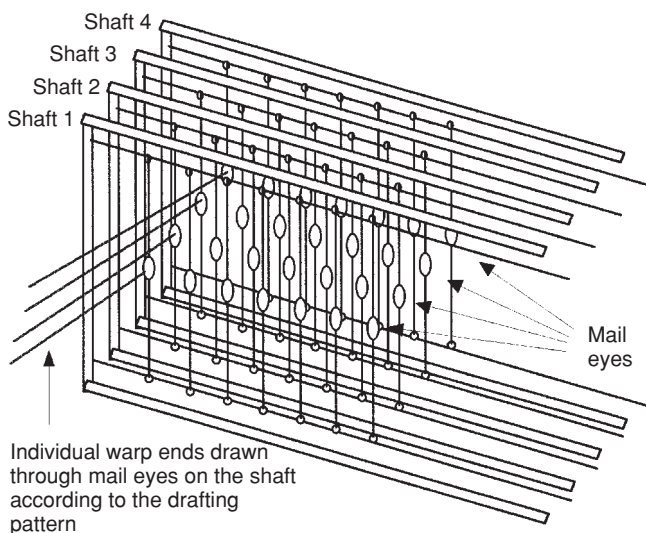

Shaft 4			4	
Shaft 3			3	
Shaft 2		2		
Shaft 1	1			

Drafting pattern indicating the order in which the ends are drawn through the shafts – repeated across full width of fabric. This illustrates a four-shaft straight draft

### 3.12 Set up for a four-shaft Dobby style fabric.

jacquard mechanism mounted above the loom. A typical harness would have in each division 1248 individually controlled ends to create one repeat of the design so if the warp were set at say 48 ends per inch the design repeat capable of being produced by such a harness would be  $1248/48$  or 26 inches. If the cloth width required was say 78 inches or 198 cms this would require  $78/26$  or three repeats of the harness division across the full width of the loom creating three full repeats of the design across the full width of the cloth. This would in fact be the harness design for that particular loom and although it has great flexibility in terms of design in that any weave combination or pattern figure can be created within the repeat of the 1248 ends, it is less flexible when it comes to requiring different warp settings (i.e. ends per inch). Settings which are less than that for which the harness has been designed (in our example 48 ends per inch) can be accommodated by 'casting out' the harness – this simply means not using all the harness cords which are available – but it is impossible to produce fabrics which require a higher set than the harness – in these cases the only answer is to purchase another harness.

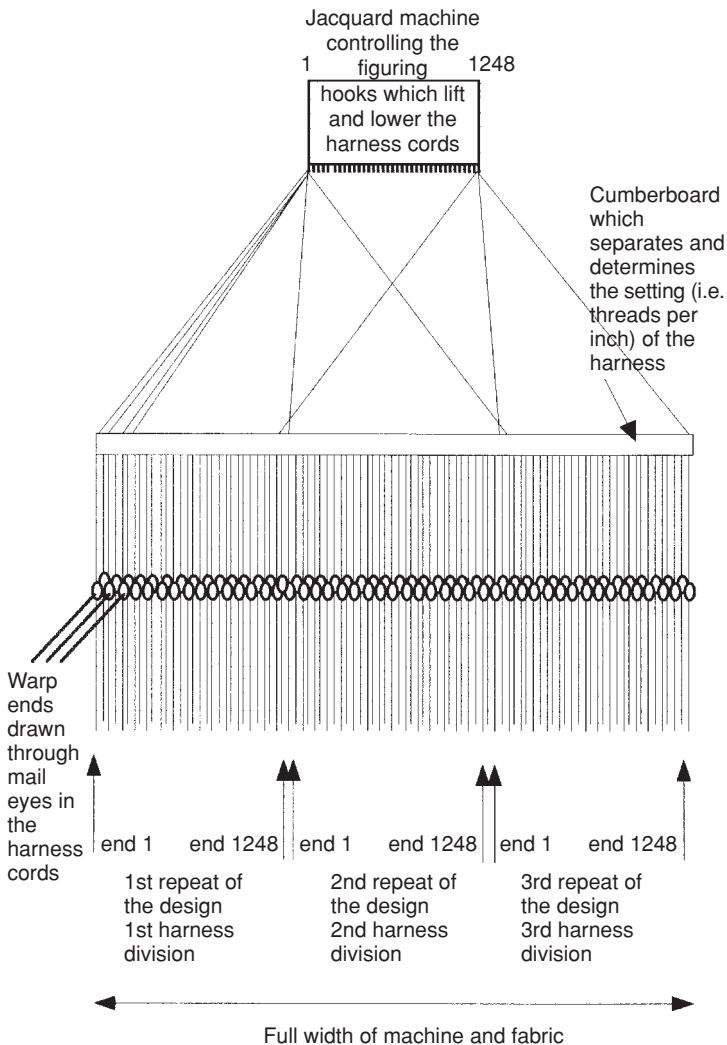

In 'cast out designs' ends are drawn through only some of the harness cords thus reducing the effective set or ends per inch in the fabric. This system enables a variety of different fabric structures to be woven in the same harness.

**3.13 Typical jacquard harness arrangement.**

The harness cords are controlled by the jacquard mechanism which has the ability to lift and lower each cord individually within the repeat to create the pattern. Nowadays almost all of the mechanisms are controlled electronically and designs can be programmed onto floppy disks which slot into a controller on the loom and create the lifting pattern of the ends which in turn creates different weaves to produce the design.

Figure 3.13 provides a schematic of the main elements of a jacquard and harness arrangement mounted over a loom.

Although the jacquard mechanism was invented in 1790 by Joseph-Marie Jacquard from Lyon, France, it was not until the latter part of this century that the original mechanical arrangement invented by Jacquard was supplanted, almost world-wide now, by the electronically controlled machine. The leading developer of this has been the Bonas Machine Company, Gateshead, England.

### 3.2.3 The weaving machine (or loom)

The weaving machine which produces the fabric can operate, with certain modifications, either a dobby or a jacquard – in effect the dobby or jacquard provides the figuring capacity and the loom provides the mechanics for actually weaving the fabric. There are many methods used for propelling the weft yarn across the warp. The original way was with a shuttle loaded with a bobbin of yarn but nowadays, this has largely been superseded by water jets, air jets, rigid rapier, flexible rapiers, projectiles or ‘bullets’ etc.

The weaving of automotive fabrics demands a system which can efficiently handle a wide variety of yarn types and counts in both warp and weft, can insert from a variety of packages and select many different colours as required by the design. One machine which has been particularly successful at this is the Dornier rigid rapier system. In this method the weft thread is propelled across the width of the fabric by two rigid rapiers each carrying a gripper which grips the thread on the entry side of the fabric, takes it half way across the cloth and transfers it positively to another gripper propelled by the rapier on the other side which completes the journey. This positive method of transfer is unique to the Dornier system and is an important feature when weaving high-quality fabrics particularly for the automotive industry. The individual weft threads are presented to the grippers by selectors and the versatility of the machine means that 12 or more different yarns or colours can be used in the same fabric of widely differing thickness and type as illustrated in Fig. 3.14.

The Dornier type P weaving machine and its various parts including the VDU control station are illustrated in Fig. 3.15 which shows a dobby mechanism for controlling the warp ends whereas Fig. 3.16 shows a similar machine but mounted under a jacquard head with a harness controlling the warp.

Computer control of the jacquard pattern is, nowadays, complemented by similar computer-driven, programmable controls of such things as dobby shafts, warp yarn let-off and fabric take-up, weft selection and control and

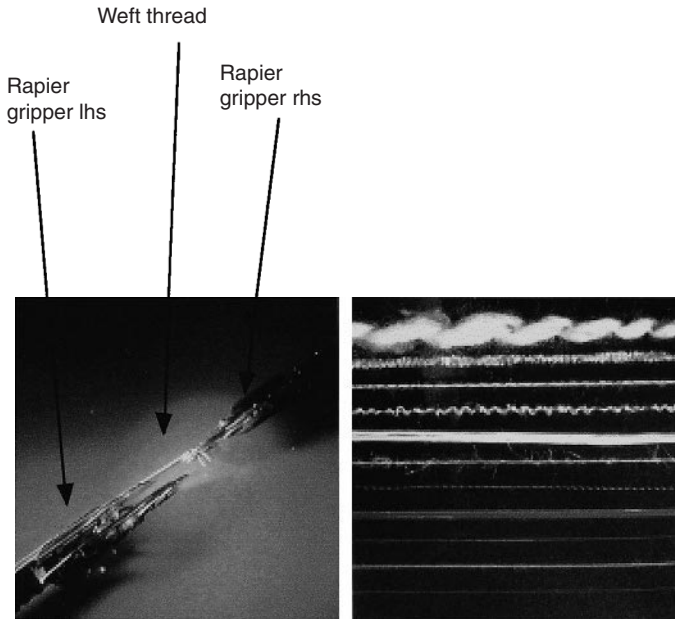

As weft is transferred from left-hand to right-hand of fabricy

Typical range of weft varns which can be woven on the Rapier loom – app 8 Decitex to 33000 Decitex

3.14 Dornier rapier gripper arrangement and typical weft which can be efficiently handled. (Reproduced by kind permission of Lindauer Dornier Gesellschaft mbH.)

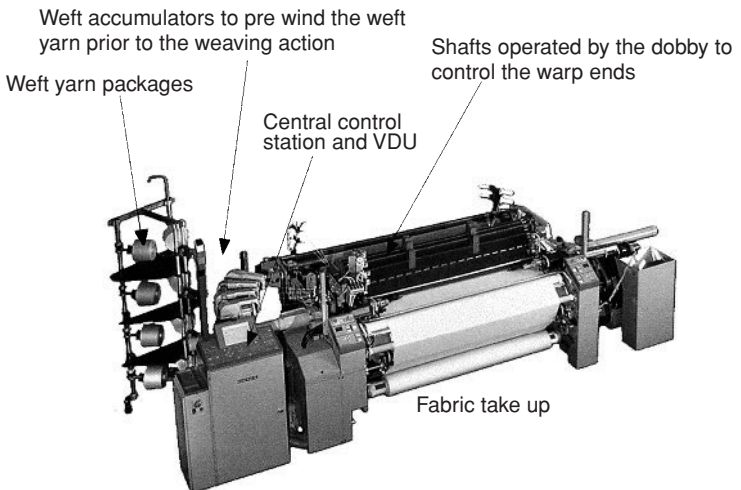

3.15 Dornier model P weaving machine with warp ends controlled by a dobby mechanism. (Reproduced by kind permission of Lindauer Dornier Gesellschaft mbH.)

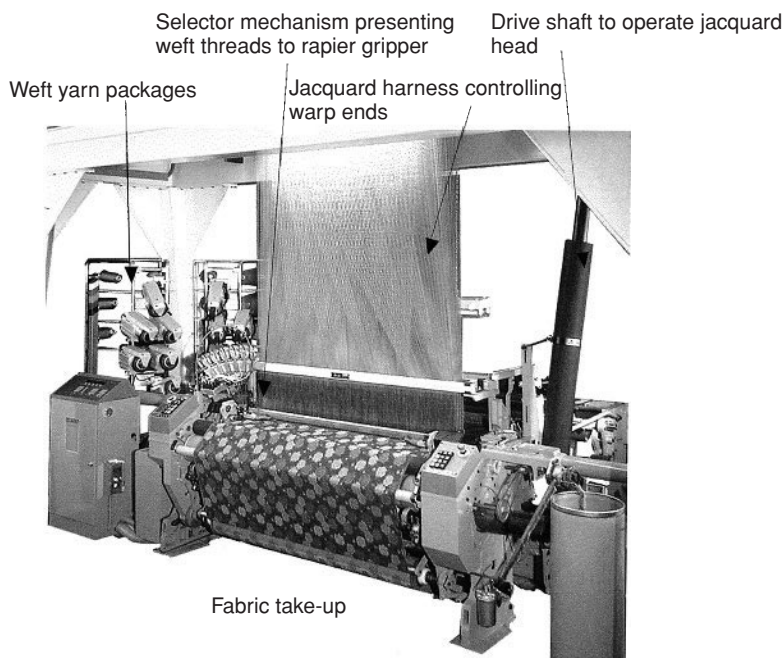

3.16 Dornier model HTV 12/J Rapier weaving machine mounted beneath electronic jacquard. (Reproduced by kind permission of Lindauer Dornier Gesellschaft mbH.)

an increasing number of other features such as variable pick rate which ensure that the fabric designer and technologist are presented with possibilities not dreamt about only a few years ago.

### 3.2.3.1 *Fabric constructions*

The construction of any flat-woven fabric is determined by the nature and type of the warp and weft yarns, the weave or interlacing pattern and the setting of the fabric in terms of ends per inch or cm and picks per inch or cm.

There is a general requirement to go lighter in weight for reasons of fuel economy etc but this is tempered by the requirement to meet physical tests and also by the possible design requirement to create design detail and colour content by 'cramming' the warp or weft yarns (cramming is a weaving technique used to increase end or pick rates beyond what would normally be considered adequate specifically to produce dense colour or design details).

The result of this is that the 'normal' range of weights for flat-woven fabrics is usually between 250 and 350 g per m<sup>2</sup> (7.4 to 10.4 oz per yd<sup>2</sup>) with

occasional 'crammed' fabrics reaching up to 450 g (13 oz/yd<sup>2</sup>). These weights are based on the 'singles' fabric – i.e. before coating or lamination.

In order to achieve this sort of weight range many different combinations of yarns and settings can and are used, Dobby fabrics can be produced using almost any combination of end, pick and yarn, but jacquard fabrics are usually standardized within a particular manufacturing plant due to the expense and difficulty of changing the harnesses which determine to a certain extent the ends per inch.

Some possible combinations are listed below with counts shown in both Decitex and English cotton count – approximate weights which include an estimate of yarn crimp are shown:

Warp	Ends cm (inch)	Weft	picks cm (inch)	Singles g/m <sup>2</sup> (oz/yd <sup>2</sup> )
420 dtx (14 cc or 2/28 cc)	20 (51)	830 dtx (7 cc or 2/14 cc)	17 (43)	236 (7.0)
540 dtx (11 cc or 2/22 cc)	20 (51)	830 dtx (7 cc or 2/14 cc)	16 (41)	254 (7.5)
420 dtx (14 cc or 2/28 cc)	40 (101)	540 dtx (11 cc or 2/22 cc)	20 (51)	289 (8.5)
540 dtx (11 cc or 2/22 cc)	25 (64)	830 dtx (7 cc or 2/14 cc)	18 (46)	298 (8.8)
420 dtx (14 cc or 2/28 cc)	30 (76)	830 dtx (7 cc or 2/14 cc)	20 (51)	307 (9.0)
830 dtx (7 cc or 2/14 cc)	20 (51)	830 dtx (7 cc or 2/14 cc)	16 (41)	315 (9.3)
1300 dtx (4.5 cc or 2/9 cc)	15 (38)	1300 dtx (4.5 cc or 2/9 cc)	12 (30.5)	368 (10.8)
830 dtx (7 cc or 2/14 cc)	25 (64)	830 dtx (7 cc or 2/14 cc)	18 (46)	375 (11)
600 dtx (10 cc or 2/20 cc)	40 (101)	600 dtx (10 cc or 2/20 cc)	30 (76)	441 (13)

It may be useful at this stage to consider the calculation for fabric production which is directly related to the picks per inch [or cm.]

### 3.2.3.2 Production rates

The production rate of both flat- and pile-woven structures is dependent upon three primary elements: picks per inch (or cm); weaving speed in picks per minute; weaving efficiency.

Once these three factors are known the calculation is straightforward according to the formula.

$$\text{Production in metres per hour} = \frac{\text{picks per minute of the weaving machine} \times 60}{\text{picks per cm} \times 100} \times \text{efficiency \%}$$

Example: 20 picks per cm weaving at 400 picks per minute at 80% weaving efficiency.

$$\text{Production} = \frac{400 \times 60}{20 \times 100} \times \frac{80}{100} = 9.6 \text{ metres per hour}$$

### 3.2.3.3 *Design and fabric development*

The designing and development of the yarns and fabric structures still rely on the tried and trusted methods of weaving and finishing samples. Certain yarns have become almost standards, such as 830 decitex parallel textured for warp yarn and textured with overfeed effect on parallel core for weft. Such yarns are capable of producing a wide range of fabric weights in a variety of structures which have met the testing requirements of most OEM's world-wide.

Development is now centred upon devising new yarn effects and weave structures to allow innovative fabrics to be produced. In this context the importance of weave development (i.e. the specific order of interlacing of warp and weft yarns) cannot be overemphasized since clever designing and innovation in this area can enhance visual design effects and mean the difference between fabrics passing and failing tests.

Finishing processes have also been important particularly with the increasing importance of flexibility in fabrics. In its simplest form a woven cloth simply needs a stenter finish to set the yarn and structure before it is laminated but by adding wet processes it is possible to better relax and consolidate the fabric, which can improve both handle and abrasion performance. Finishing agents such as softeners, anti-static agents etc can also be applied.

By including surface actions such as brushing, sueding etc. new fabrics can be developed which have different physical and aesthetic properties.

### 3.2.4 Weaving – pile fabrics

The basic principle of weaving pile fabrics is very much the same as flat-woven fabrics in that the ground structure of the fabric is composed of vertical warp ends and horizontal weft threads. However the pile takes the form of additional warp threads controlled either by pile shafts in a dobby-woven cloth or by a jacquard harness in a figured-jacquard structure. In both cases the design of the fabric is created by the vertical pile ends which form the surface of the cloth.

Many systems have been developed to manufacture this type of fabric including wire looms for the production of cut and uncut moquette but the one which has dominated particularly the automotive sector is the 'double plush' or 'face to face' system. One of the main reasons for this is the fact that two fabrics are effectively woven at the same time one above the other joined together by the pile warp ends which cross from top cloth to bottom cloth according to the design and during this weaving process a knife situated between the two cloths continuously traverses the width of the fabric cutting the pile warp threads to create two cloths each with a cut warp pile

surface. It is important to appreciate that a surface pile tuft is formed only when a pile end crosses from the top cloth into the bottom cloth and is cut on the loom by the traversing knife, and it is in this way that the surface pile design and colour are created. When it is not required on the surface of the fabric the pile is woven or 'incorporated' into the ground structure either in the top or bottom cloth.

Some of the more complex structures also utilize a 'reflect' warp principle where there are areas of no pile which reveal the ground structure as part of the design. This is a principle that is widely used in the domestic upholstery business but has to be used with care in automotive due to issues with the uneven surface causing abrasion and other performance problems. The two obvious results of this system are that the production costs are reduced due to the simultaneous production of two cloths and also that the design on the top cloth is a mirror image of the design on the bottom cloth – a feature of particular importance when planning fabrics and seats to be made from jacquard-woven designs.

The main function of the ground yarn is to support the structure and create a base which meets tensile and seam fatigue requirements. However, any stretch requirements would be a function of ground yarn and structure and would have to be approached in the way described for flat wovens although there would be much less opportunity to influence yarn crimp.

The pile yarn is the main feature and must meet aesthetic design, colour and the main technical requirements such as lightfastness, abrasion, crush resistance, tuft adhesion.

Special looms are used to weave face to face velvets. These insert two picks at a time, one top cloth, one bottom cloth, but use conventional shaft arrangements controlled by a dobby or alternatively a jacquard harness to control the pile ends. The looms are quite complex and since variable take-up of threads is part of the weaving process, complex warp yarn let off and tension-compensating devices are required. The situation in jacquard is complicated by the fact that each of the several thousand individual pile warp ends is incorporated into the cloth at a different rate which means that all the ends come from a separate package all mounted in a creel utilizing a negative system of yarn feed controlled by friction tension devices.

There are many different weave structures associated with velvet particularly in relation to the interlacing of the pile yarns and often velvets are referred to as 'V', 'U', or 'W' weave. This refers to the individual tuft formation and is illustrated in Fig. 3.17. It is immediately apparent from this that the densest pile will be formed from the 'V' weave but it will also have the lowest tuft adhesion since each tuft is only anchored by one thread. 'U' weave has a lower pile density, and 'W' weave has a low density but a high tuft adhesion since it is anchored by three threads. For automotive uses the

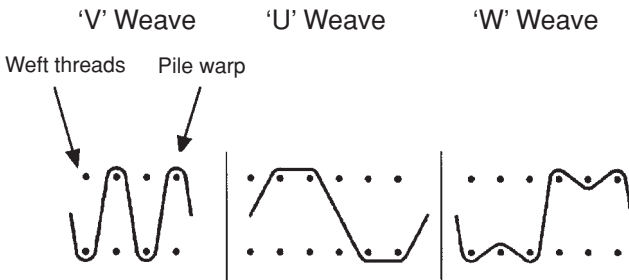

3.17 Illustrating the three main pile warp interlacing techniques used in face to face woven velvet structures. 'V' weave is popular due to high pile density for any given ground structure but has low pile adhesion properties. This is improved by back coating the fabric. (For purposes of clarity the ground warp interlacing is omitted from above diagram.) (Reproduced by kind permission of Michel Van De Wiele NV.)

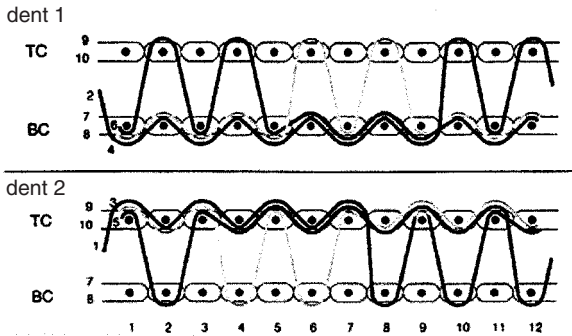

3.18 Section through a jacquard structure showing two adjacent lines of the design – dent 1 and dent 2, each one containing three differently coloured pile ends which can be crossed from top to bottom to create a design of three distinct colours plus combinations of these. When not in use the pile ends are incorporated in both top and bottom cloth to equalize fabric weight. This would be known as a 'three-frame' jacquard design and utilizes the 'V' pile principle shown in Fig 3.17 as the basis for the pile interlacing. (Reproduced by kind permission of Michel Van De Wiele NV.)

'V' pile is very popular since it produces high pile density, and tuft adhesion is improved to acceptable levels by back-coating the fabric.

Figure 3.18 shows a cross-section through a jacquard-woven structure where for every two ground ends in top and bottom cloth, there are three pile ends crossing between. It can be seen that where a tuft is formed the 'V' weave is used and where the pile end is not required on the surface it is incorporated into the ground either on the top or bottom cloth. The dents

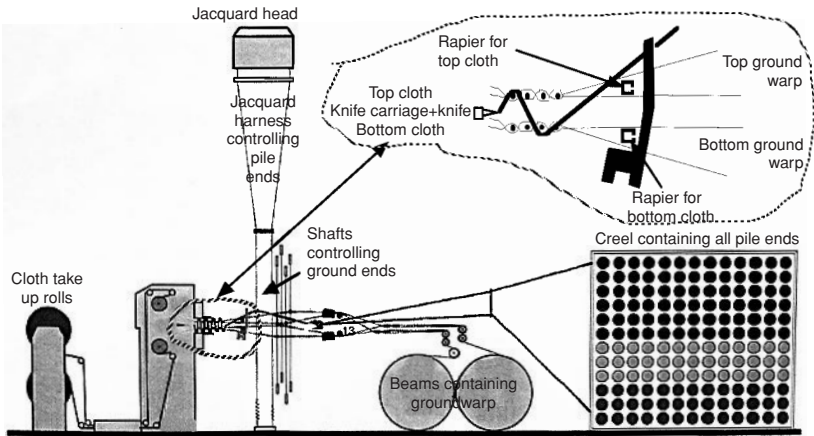

3.19 Face to face velvet jacquard weaving machine with detail inset of yarn/fabric interface. (Reproduced by kind permission of Michel Van De Wiele NV.)

refer to each vertical line of figuring, and in this structure it is possible to select any one of the three different colours of pile to create the design. Each alternate line (i.e. dent 1, dent 2) would tend to incorporate the pile into opposite cloths in order to create a balanced weight structure between the top and bottom cloths, and the weave selection to do this is part of the highly skilled job of the velvet design technician.

The looms for weaving face to face velvet cloths are, in principle at least, similar to those used for weaving flat fabrics but have many additional features to accommodate the pile ends and also the ability to weave two cloths simultaneously one above the other. The looms can be built to either use a jacquard machine to control the pile ends as illustrated in Fig. 3.19 or they can utilize a dobby mechanism for this as illustrated in Fig. 3.20. In both cases the weaving of the ground structure is very similar.

Designing for velvet fabrics is a highly skilled operation requiring specialist knowledge of the weaves, yarns, fabric structures etc. Since the ground cloth is rarely seen, it is usual to try to minimize weight and cost of ground yarns consistent with tensile and tear strength requirements. However, they do have an effect on the adhesion of the pile yarns so ground yarns which present high surface friction will help tuft retention (air-textured yarns for instance).

Pile yarns on the other hand form the fabric surface and depend upon the individual filaments 'bursting' to create a full dense surface. Attention should be paid here to filament denier and cross-section and spinning systems which allow filaments to burst – it is well known that the air texturing system employed for yarns in flat-woven automotive cloths (and which are quite good as ground yarns) does not lend itself to creating good

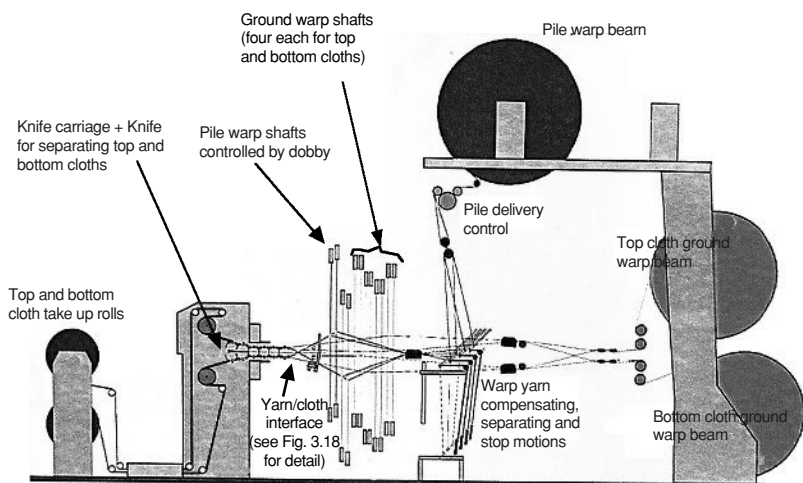

3.20 Face to face velvet dobby weaving machine. (Reproduced by kind permission of Michel Van De Wiele NV.)

pile yarns due to the high degree of entanglement of the filaments. The staple-spun or false-twist method is better in this regard.

Finishing is a vital part of velvet cloth development. After weaving the cloth is cropped to even out the pile surface and 'tigered' or vigorously brushed on the pile surface to burst the yarn filaments, cropped again to create a standard 'pile height' specification and maybe heated and brushed again to thermally set the pile at a specific angle. Totally vertical pile looks good but is not favoured since in use it does not present a uniform appearance when individual filaments crush in different directions. A slight angle to the pile causes the filaments to crush in a similar direction presenting a more even light reflection and appearance in use.

Woven velvet structures have been, and still are, highly regarded as an up-market product for automotive trim, particularly in Japan where they compete with leather in the higher trim levels and in excess of 20% of the textile trim market has been accounted for by woven velvet fabrics mainly of 'V' weave structures. In America the 'V' weave predominates and has in recent years accounted for around one-third of the trim market. However this tendency has been less pronounced in Europe where the market share has been somewhat less than 10% with 'W' weave featuring in better qualities with wool or wool-blend pile yarns. The reason for this low market share is unclear but could be associated with the high cost and also because velvets are even more difficult than flat-woven cloths to produce with stretch to match modern seat and interior design. They have also faced intense competition in Europe from innovations in jacquard circular-knitted structures which have inherent stretch characteristics and, despite

their more limited capability to exploit novel yarn characteristics, have in recent years taken a large share of the pile fabric market.

#### 3.2.4.1 *Design and development*

The designing of velvet fabrics requires the same attention to CAD, yarn development and finishing as flat-woven cloths. Efficient CAD packages are now available to design and simulate velvet fabrics in printouts.

Yarn development concentrates on developing standard ground yarns which are cheap, which meet the strength requirements and are at the correct count level to give the correct density and weight. They should also display a high surface friction in order to form an efficient anchor for the pile yarns to maximize tuft retention, and it is this property which tends to favour staple-spun yarns or air-textured filament yarns as ground yarns for automotive velvets rather than flat- or false-twist filament which are cheaper. However, there is a trade off in terms of cost since tuft retention can be increased by the application of a back coating and it may be cheaper in the final analysis to use a cheap flat-filament ground yarn and apply a heavy back coating. Development trials and testing are the way to verify the suitability. Once this has been decided the effort should be diverted to the pile yarns which form the aesthetic surface of the fabric as these can be of an infinite variety with a much greater choice available than for say, the circular-knitted pile cloths. However the performance requirements tend again to limit the choice to fibres which can display light and UV resistance and good abrasion performance. Since woven velvets tend to be expensive and have an up-market image just under that of leather in Europe and Japan (less so in the USA), the trend has been to use wool or wool blended with polyester as pile yarn for automotive in counts ranging from 2/17s metric to 2/28s metric in 70/30 polyester wool-blend fibre dyed and worsted spun. Wool blended with nylon has for a long time been prominent for public transport.

#### 3.2.5 Woven cloth characteristics

By their very nature, woven structures are rigid or semi-rigid in the vertical and horizontal directions with only slightly more flexibility in the bias direction. Over recent years this has become a handicap due to the increasing requirement for stretch substrates to allow greater flexibility in the design and manufacture of both seats and door panels. This situation has affected both flat- and pile-woven cloths and has been addressed by the weavers in two main ways.

Special yarn is designed to incorporate stretch by the use of stretch polymers for limited stretch requirement. This would include the use of poly-

butylterephthalate-type yarns where recoverable stretch was wanted or part-oriented yarn (using a feedstock which had not been fully stretched during the manufacturing extrusion process described earlier under fibres) where stretch was needed but recovery was not important (e.g. bonded door panel manufacture) or incorporating an elastomeric fibre (e.g. Lycra®) into the yarn during manufacture where much greater stretch and recovery properties are needed. These methods have met with some success in meeting a lot of the requirements and in competing with the knitted structure but have presented problems of cost and also the constant difficulty of making the same design colour in both stretch and cheaper non-stretch versions in matching fabrics.

The other solution, where only minimum amounts of flexibility are needed to overcome specific problems, requires special weaving and finishing techniques using standard yarns – this method is almost entirely dependent upon introducing yarn crimp into the fabric during weaving and/or finishing. An exaggerated view of yarn crimp is illustrated in Fig. 3.21 and it can be appreciated from this that, once developed into the fabric, it is, by the application of tension, capable of being pulled or extended thus creating a limited amount of stretch.

This crimp is influenced by such things as yarn thickness (i.e. count), yarn type, order of thread interlacing (i.e. weave) and weaving tensions. Once the fabric is woven these parameters are fixed in the fabric but can be altered by finishing techniques applied to the fabric after weaving, particularly where the fabric is wet out or scoured, relaxed and dried under various tension controls on the stenter. These techniques can, to a limited extent ‘interchange’ warp crimp to weft crimp and vice versa. When applied at the finishing stage under the influence of heat to thermoplastic fabrics such as polyester, it is possible to set the crimp in the fabric, thus making it permanent and recoverable unless the setting temperature is exceeded.

Close attention to this aspect of fabric geometry can be extremely useful in addressing such problems as surface abrasion, fabric handle, fine tuning

Vertical warp threads cross  
sectional view

Horizontal weft thread bending  
round the warp

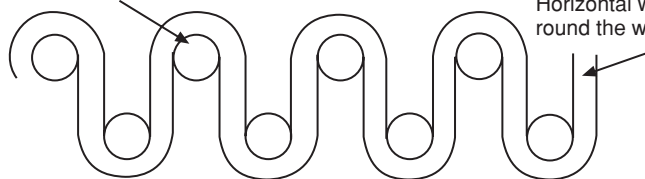

3.21 Illustration of yarn crimp which can contribute to fabric stretch in woven structures.

## 4.1 Introduction

Most car seat fabric is made from polyester fibre but there are still relatively small amounts of nylon, wool and acrylic used. Acrylic fibre is used in the roof of convertible cars because of its excellent resistance to weathering and UV degradation. Wool is, and will continue to be, used in luxury and up-market cars. The processing methods, machines and materials used for each fibre vary according to the fibre type and fabric construction. Colour lightfastness must be of a very high standard and the number of dyes available for each of the four fibre types, is relatively small compared to other applications such as domestic furniture. Automotive upholstery is fixed in place for the life of the car and cleaning in a washing machine is not possible. The only methods of cleaning are brushing, vacuuming and shampooing. This factor has contributed to restricting interior colours to generally dark shades, although this is now changing.

Fabric finishing is important, because if not carried out properly to give fabric with uniform properties, serious problems can arise in downstream processing as well as giving rise to complaints by the car buyer. An essential requirement is that the fabric has consistent stretch, dimensional stability as well as a good uniform appearance, because as will be seen, difficulties could arise in seat making. The synthetic fibres, polyester, nylon and acrylic are thermoplastic, which means that they will melt if heated to a sufficiently high temperature. Fabrics made from them will shrink readily with heat unless they have been heat set.

Yarns are normally lubricated at various stages of processing to reduce static electricity and to help improve the efficiency of winding, texturizing, warping and weaving. In addition, residual dyebath chemicals can still be present on the yarn. These lubricants and processing chemicals, loosely referred to as 'oil', are best scoured off before the fabric is dressed flat on the stenter. Scouring provides a number of benefits including reducing the phenomenon of fogging, which can be caused by the 'oils' vaporizing off

under the action of hot sunlight and condensing on the car windscreen thus reducing visibility.

Very few actual fabric finishes are applied to automotive fabrics compared to say apparel materials. Some OEMs request a soil-release finish or an anti-static finish, but they have to be carefully chosen, for reasons which will become clear later. A back coating is sometimes applied to woven fabrics to improve abrasion resistance, and in some cases, to impart a measure of flame resistance. A coating to help lock in the pile is important for woven velvet fabrics.

After finishing, the fabric is laminated to polyurethane foam, and a scrim is laminated on to the back of the foam to produce a triple laminate. As already noted the scrim acts as a slide aid, but it also helps seam strength and seam fatigue. With knitted fabrics, the scrim helps control stretch and scrims of different construction and properties are required for different knitted-face fabrics. Flame lamination is widely used as the method of producing the triple laminate. This process is economical and produces a laminate with the required handle and drape, such as the ability to bend around concave and convex curves without 'cracking'. The lamination process can be accomplished with a single pass but it burns off a layer of polyurethane foam producing potentially toxic fumes which have to be treated before release to atmosphere. Several alternative lamination methods have been developed and proposed to replace it. This aspect is discussed later in this chapter and in Chapter 8.

The processing sequence for the production of both woven and knitted car seat fabrics can be summarized:

		Parent yarn texturize (if applicable)	
yarn package dye	warp/beam	yarn package dye	yarn package dye
warp/beam	<b>warp knit</b>	wind on to cone	wind on to cone
<b>weave</b>	brush/crop	<b>weft knit</b>	<b>3D knit</b>
scour	stenter preset	shear	heat stabilise
stenter/finish	scour/dye	scour	fit to seat
foam laminate	stenter	stenter/finish	
cut/sew	brush	foam laminate	
fit to seat	stenter finish	cut/sew	
	foam laminate	fit to seat	
	cut/sew		
	fit to seat		

Sometimes it is necessary to vary the processing sequence and to add to it, for particular yarns or to optimize certain properties. Printing is carried out on prepared fabric; the significant advantage is that many of the con-

straints of weaving and knitting are absent, and the design decision, can be made closer to the launch date of the car. This enables the design to be right up-to-date, and there are also possible cost savings, because the new printed fabric may not have to be put through the full testing and acceptance procedure if a different print design is put on to an existing and already approved base fabric.

## 4.2 Dyeing and finishing

### 4.2.1 General principles of dyeing

Dyeing is a very complex operation; the following is a simplified account of the theory and principles, but deals only with processes relevant to automotive fabrics. Dyeing has been described as essentially putting material into a pot of water and stirring. In reality the water is either pumped through the material or the material is drawn through the water. Either way the objective is to provide good liquor circulation by stirring or agitation to obtain a level uniform dyeing. Heat is also applied to make the process go faster. For economic and commercial reasons, the dyeing must take place as fast as possible, using the least amount of water, but it must also be level, on shade, and make full use of the dyes. Dyes are expensive chemicals and so as much as possible should go on the yarn or fabric, and not remain in the water at the end of the dyeing process. Thus dyeing machines are designed to accomplish a quality dyeing quickly, using the minimum amount of water, but they must also preserve the properties, texture and other aesthetics of the substrate, i.e. the yarn or fabric. Economical use of water and full use of the dye also minimizes effluent problems as will be made clear in Chapter 8.

Dyes are organic molecules consisting in general of two parts; one part is synthesized to produce the colour, the other part is designed to have affinity for a particular fibre. Different fibres have different positions or sites on the polymer molecules, which attract particular classes of dye. Nylon and wool are dyed with acid (anionic) dyes, acrylic fibres are dyed with basic (cationic) dyes. Polyester with no specific chemical sites for dyes, is dyed with dyes called disperse dyes which occupy spaces within the polyester polymer network.

Fibres, especially synthetic fibres, are made up from long polymer chains which in some areas of the polymer network can be closely packed and relatively parallel to each other (called crystalline regions), or more tangled and more loosely packed areas (called amorphous regions). The amorphous regions are more accessible for dye penetration because they are more open. When heat is applied above the glass transition temperature ( $T_g$ ), the polymer chains are able to move about more freely and to swell, to allow

the entry of dye into the more crystalline regions in addition to the amorphous regions. Thus the higher the temperature, the faster the dye uptake and this factor is especially important for polyester fibres, which have no specific dye sites, nor any special affinity for dyes. This is the reason why polyester must be dyed at high temperatures, above the boiling point of water and in pressurized dyeing machines. It is possible to swell polyester using 'dye carriers' and dye at lower temperatures, but this is seldom done because the 'carriers' are environmentally unfriendly chemicals. The disperse dyes, once inside the polymer chain network are trapped, cannot escape easily and therefore have good fastness.

Dyes must go on the fibre quickly, but they must also go on uniformly to produce a level appearance. Rate of dyeing and levelness are controlled by temperature increase, and by the use of chemical dyeing auxiliaries. Polyester dyeing auxiliaries help to dissolve and disperse the dye uniformly in the water. In the case of acid dyes for nylon or wool, auxiliaries can control the rate of dyeing by forming temporary complexes with the dye, thus holding it off the fibre or by blocking the dye off the fibre by temporary occupying dye sites on the fibre.

At the molecular scale, dyeing takes place by three fundamental steps, dissolution of the dye in water, movement of the dye to the fibre and adsorption on to the fibre surface, and finally penetration and diffusion of the dye inside the polymer network. This last step is very important for dye-fastness. If the dyeing cycle is too short, or water circulation not effective, the dye will be concentrated on the outside of the fibre, and will be easily removed in a fastness test such as wet perspiration, rubbing or crocking. The lightfastness is also likely to be lower than expected. This condition is referred to as 'ring dyed'.

Shades are usually produced by mixtures of dyes and the trichromatic mixture of a red, blue and yellow dye is usually the most versatile. However, because each dye has its own special character and rate of dyeing, the best results are obtained by mixtures of dyes with similar characteristics, and which are compatible with each other. Incompatible dyes can block each other off, and mixtures of dyes with different dyeing rates can produce uneven dyeings, and batch-to-batch variation, see Fig. 4.1. The dye and dyeing auxiliary chemical makers, compete with each other by providing advice and technical service. They recommend dyes, recipes and dyeing methods suitable for the end use as well as those best suited for a particular dyeing method. Many dyes produced by different manufactures are identical chemically, and share the same Colour Index Number, (e.g. Acid Red 80), assigned by the Society of Dyers and Colourists (UK) and the American Association of Textile Chemists and Colorists. Several articles have appeared in the technical press specific to the dyeing and finishing of automotive textiles.<sup>1-5</sup>

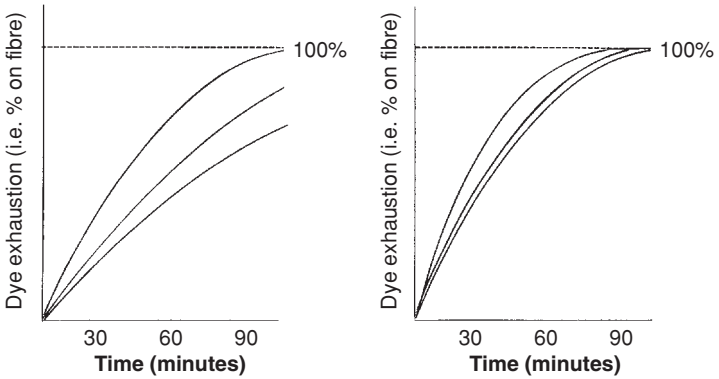

The three dyes in the mixture have different characteristics – poor batch-to-batch reproducibility likely.

The three dyes in the mixture have similar characteristics – good batch-to-batch reproducibility likely.

- 4.1 Dye mixture compatibility. Dyeing with dye mixtures, e.g. trichromatic mixtures. For batch to batch reproducibility, all the dyes in the mixture should have similar dyeing characteristics. Ideally, dyes in the same mixture should have similar dyeing rates and final exhaustion values for reproducible results. Dyers sometimes struggle to obtain this ideal with the small number of dyes available which have the high performance requirements necessary for automotive use.

#### 4.2.2 Laboratory recipe preparation

Everyone working with colour should first be tested for colour-defective vision, using standard ‘colour confusion’ test patterns such as Ishihara. Any colour can be specified by the use of three quantities termed, hue, value and chroma. These qualities can be represented in a three-dimensional diagram, the ‘colour solid’, see Fig. 4.2. Hue refers to how it appears as red, blue, yellow, etc. Value, also termed saturation, is the white/black content, i.e. whether the colour is a strong or deep shade or a pastel shade. Chroma expresses the ‘grey’ content or vividness or brightness. There is a fourth quantity termed ‘metallic brilliance’ in SAE J361, (recommended procedure for visual evaluation of vehicle interior and exterior automotive trim), which refers to the metallized or opalescent appearance, but this fourth quantity is more associated with plastics and metal than fabric. The Munsell Book of Colour contains a large number of standard colour samples arranged according to the colour solid. Any shade can be described by matching it to a standard sample in the book, which are specified using Munsell notation representing the hue, value and chroma.

Every colour can also be specified in numerical terms based on information obtained by an instrument known as the spectrophotometer, which measures the reflectance of light in each part of the spectrum. An

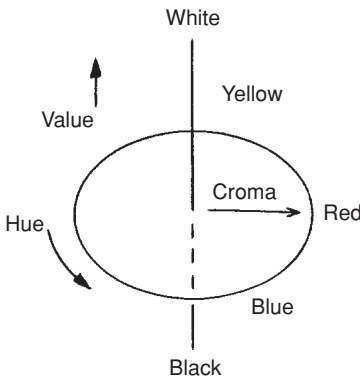

4.2 The Colour Solid. Hue refers to appearance, yellow, red, blue, etc. Value (saturation), is the 'white/black' content. Croma expresses the 'grey' content or 'brightness'

alternative instrument is the tristimulus colorimeter, which measures the reflectance for each of three colours. The information in both cases can be expressed as the 'chromaticity co-ordinates which represent the lightness/darkness ( $L$ ), the redness/greeness ( $a$ ), and the blueness/yellowness ( $b$ ), as seen by a standard observer. This information is then fed into a colour computer, which has been programmed with a data bank of information of colours and shades obtainable by a range of dyestuffs both individually or in combination with each other. These dyestuffs will have been specially selected for automotive use on particular fibres. From the input information, the computer is able to produce a dye recipe to give any shade on the specified fabric. This recipe and a suitable dyeing procedure can then be evaluated in the dye laboratory and if necessary, adjustments can be made to produce a closer matching. Matching of shades by computer techniques has been available for many years and is being continuously improved. It is possible mathematically to convert chromaticity co-ordinates to Munsell notation and vice versa.

The shade must be viewed under agreed lighting conditions, preferably using a standard source of illumination, see also colour approval, Chapter 5. This is especially important in automobiles when not only the same fabric processed in different factories, but also leather, plastics and other materials all produced to the same colour may come together in the same car interior. If precautions are not taken they could all appear slightly different when viewed in different lighting conditions. This phenomenon is known as 'metamerism' and arises because the different shades or individual dyes in the shades, may have the same spectral absorption curves in daylight, but are different under say tungsten or some other artificial light. To avoid

metamerism, careful dye selection is important; the individual spectral curves on each substrate should be the same at all wavelengths, and under lighting conditions specified by the customer. For this reason, use of a spectrophotometer is preferred to use of a tri-stimulus colorimeter.

In order to accurately reproduce the laboratory shade in bulk commercial dyeings, it is essential that the same dyeing method (rate of temperature rise and time), dyeing recipe, dyes, liquor-to-goods ratio, chemicals and even water are used in both the laboratory and the actual dyehouse. Extremely careful weighing and dispensing of dyes and chemical are essential for on shade dyeings, which must be right first time if the dyeworks is to operate economically. In a modern dyeworks, operative error and human variation are much reduced by automated dispensing systems both in the laboratory and main works, which provide accurate and consistent weighing and dispensing of dye and chemical.<sup>6,7</sup> Shade additions add significantly to time and cost, and 'blind dyeing' techniques – i.e. when the shade is not examined until the dye cycle has ended and the goods taken out of the dyeing machine, are now the order of the day for profitability especially where automotive fabrics are involved. Figure 4.3 shows the action in some dyeing machines and Fig. 4.4 shows a laboratory sample dyeing machine.

### 4.2.3 Yarn package dyeing

Yarn is first wound on to a former or 'dye spring' to prepare a package of yarn usually weighing about 1–2 kg. Skill is needed in this operation to produce a package of uniform density, which is essential to obtain a level dyed package. Also the correct tension is necessary to allow for any shrinkage which could occur, causing layers of yarn to crush those layers underneath and thus damage texture. In extreme cases the textured yarn can be flattened into a tape-like appearance. Also high yarn shrinkage could produce hard areas within the package thus restricting liquor flow causing dye unevenness.<sup>8,9</sup> When the yarn is woven or knitted into fabric these factors could produce an irregular appearance such as unlevel dyeing or lustre stripes.

Packages of yarn are placed on top of each other on a perforated spindle; each dyeing machine containing several spindles, see Figs. 4.3 and 4.5. Most modern package dyeing machines are pressurised and operate at temperatures above the boiling point of water, where maximum penetration and maximum efficiency of the pumps is obtained. Dye liquor is pumped through the packages via the spindle – this process being termed inside to outside flow. The liquor can also be reversed and pumped into the perforated spindle via the yarn packages – this process is termed outside to inside flow. The whole dyeing procedure, including rate of temperature rise is computer controlled for batch-to-batch consistency. Package dye levelness can

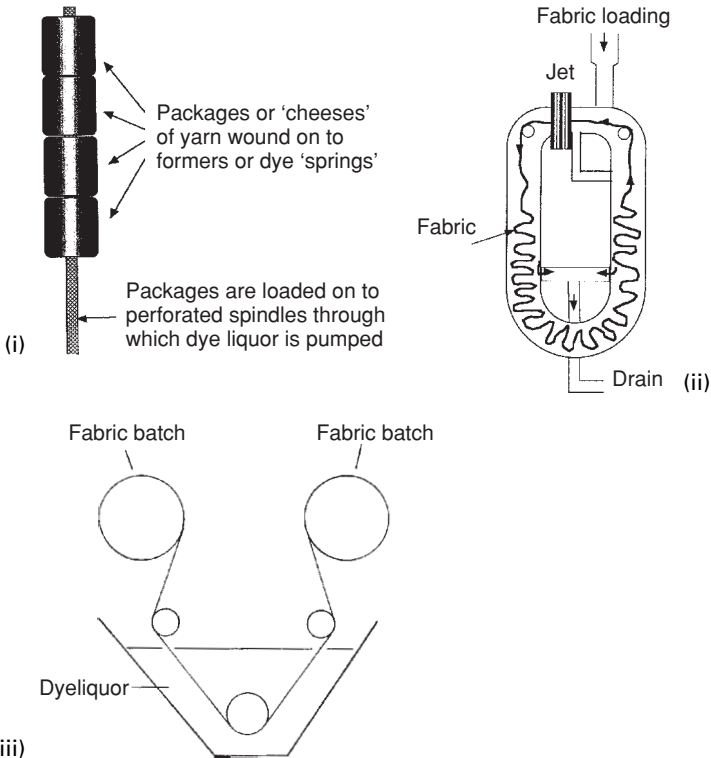

4.3 The action of some dyeing machines used in automotive fabric production. (i) Package dyeing/beam dyeing, the dye liquor is pumped through each package of yarn, which must be wound with uniform tension for a level dyeing. However yarn shrinks under the conditions inside a dyeing machine and package winding and preparation are skilled and complex operations. **Beam dyeing of fabric** uses similar principles; the dye liquor is pumped through layers of fabric wound on to a perforated spindle called the beam. Fabric shrinks during dyeing and must be heat set to stabilize it beforehand. (ii) Jet dyeing, fully immersed fabric is drawn through the dyeli liquor by the jet. The machine is pressurized and the liquor is above the boiling point of water. The size and design of the jet are regulated to suit the fabric being dyed. (iii) Jig dyeing, the fabric passes open width from one roller to the other through the dye liquor. Thus the fabric is kept flat the entire time during dyeing and creases are prevented.

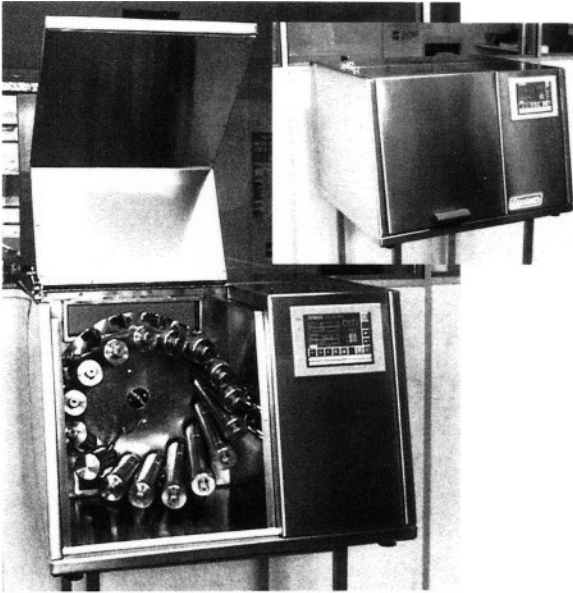

4.4 Laboratory sample dyeing machine with infra-red heating.  
Reproduced with kind permission of Roaches International Ltd.

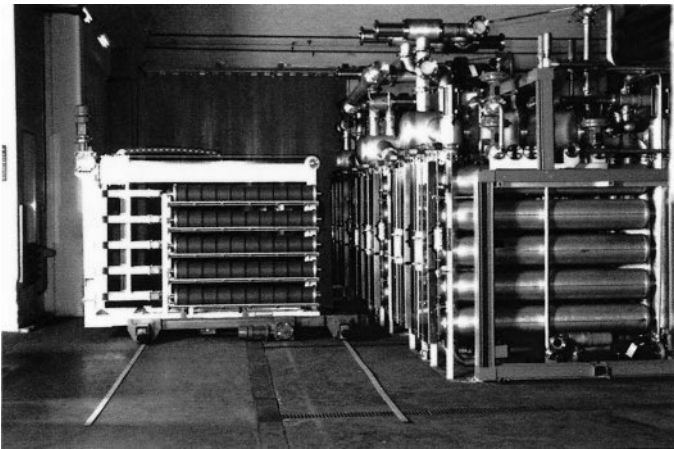

4.5 Commercial yarn package dyeing machine. Each horizontal spindle has its own individual dyeing tube for maximum efficiency and dye evenness. Courtesy of Obem Dyeing Machinery/Border Textiles (UK) Ltd. and reproduced with kind permission.

be assessed by taking a sample of yarn from the outside of the package and knitting it adjacent to a sample taken from the inside of the package and then viewing them side-by-side in a light cabinet. Yarns of high dtex such as carpet yarns or very high bulk can be dyed in muffs, i.e. softly wound packages without a former or in hank form. After the completion of dyeing an antistatic agent or lubricant is applied to facilitate yarn winding.

#### 4.2.4 Fabric (piece) dyeing

Knitted polyester is invariably dyed in a fully enclosed pressurized jet-dyeing machine, where the fabric is forced through the machine by vigorously moving dye liquor. In addition it passes through the jet or nozzle, the action of which adds to the agitation and turbulence inside the machine, see Figs. 4.3 and 4.6. There are a number of jet machines of various configurations, each designed to optimize a particular dyeing or fabric-handling aspect, and each is considered best suited for a particular construction of fabric. All jets are operated above the boiling point of water, about 130 °C.

Knitted nylon fabric can be dyed on a beam which is a perforated spindle on to which preheat-set fabric is wound, and liquor pumped through it, in a similar way to the package dyeing machine. It is essential to heat-set the fabric first to stabilize it, otherwise it could shrink on the beam during dyeing causing watermarks, loss of texture, creasing and in extreme cases 'telescope' off the beam, or even cause the beam to collapse.

Rigid-woven fabric that is woven from non-textured yarn, such as taffetas which are prone to creasing, are dyed open width on a jig machine

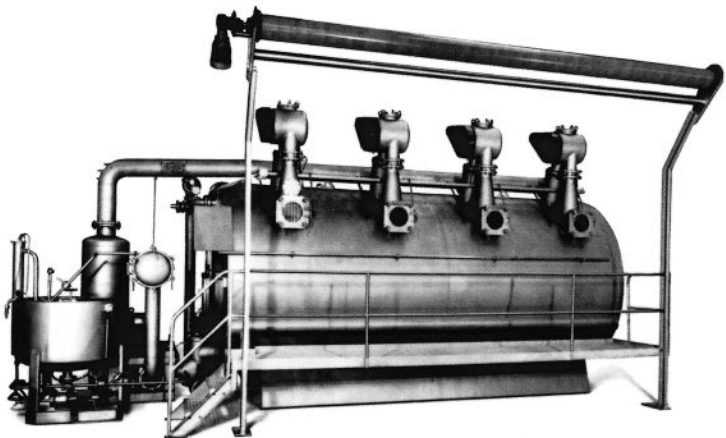

4.6 HT eco-soft general purpose jet dyeing machine for both heavy and lightweight knitted and woven fabrics. Courtesy of Thies (UK) Ltd. and reproduced with kind permission.

(Fig. 4.6). The dye process consists of winding and rewinding the fabric from one large roller to another through the heated dyebath. In this way the fabric is never folded or creased. For polyester the machine is enclosed and pressurized to obtain temperatures above the boil.

#### 4.2.5 Polyester dyeing

Polyester requires high temperature above the boil to achieve build up of dye.<sup>10</sup> Disperse dyes are sensitive to alkali and so polyester is generally dyed under acidic conditions – a new technique of *alkali dyeing* is described later in this section. An example of a dyeing procedure and recipe using Clariant chemicals is:  $x\%$  disperse dye; 2–4% Fadex F liquid; 1–2 g/l Sandacid PB liquid (to give pH 4.5–5); and 0.5–1 g/l Lyocol RDN liquid.

Sandacid PB liquid is a blend of organic acids, salts and anionic dispersing agents for disperse dyes. Lyocol RDN liquid, is an additional dispersing agent for disperse dyes. The inclusion of a UV-absorbing agent such as Fadex F can improve the lightfastness further by up to 1–2 points, as well as reducing fibre damage by photochemical degradation. Dye recipes must be accurately prepared first in the laboratory, and then trialled with small pilot quantities of yarn or fabric, preferably using a small model of the type of commercial machine which will be used to dye in bulk. Disperse dyes recommended by Clariant are their Foron range prefixed with the letter A – for automotive, e.g. Foron Brilliant Red AS-5GL. Ciba recommend their Teratop selection of disperse dyes for automotive fabrics.

In fact there are only about 15 disperse dyes in existence which meet the very high lightfastness standards required for automotive fabrics. A dye mixture comprising dyes compatible with each other is more likely to produce good batch-to-batch reproducibility than a mixture containing dyes not compatible with each other, see Fig. 4.1. Sometimes however it may be necessary to use dyes together which are not ideal in terms of compatibility – because there are no alternatives to obtain the required shade. After the dyeing of polyester is complete, a thorough rinsing procedure termed ‘reduction clearing’ is usually carried out to remove all dye on the surface of the fibre which has not penetrated inside the polymer network. This process is essential to ensure that dyefastness, i.e. light, wet and rubbing is optimum.

#### 4.2.6 Oligomer reduction – alkali dyeing of polyester

A major problem associated with polyester dyeing is the presence of oligomer, which is a low molecular weight by-product of the polymerization reaction. Oligomer is believed to be mainly trimer and is present in

polyester yarn at levels up to approximately 3% or more by weight.<sup>11</sup> It appears as a white powder during dyeing and can contaminate dyed yarn or fabric and also leave deposits in the dyeing machine. Oligomer has been described as the single biggest problem in the dyeing of polyester. Regular thorough cleaning of dyeing machines is necessary to minimize the risk of oligomer contamination, which can arise in downstream processing such as weaving and fabric scouring.

Oligomer is more soluble in hot water than cold, and more soluble in alkali liquor, say pH 10 to 11 than lower acid values of pH. Thus draining the dye liquor at high temperature and at high pH values helps to remove it from the dyed goods. Special plant is normally required to do this however, as water authorities may not allow hot water and water at these high values of pH to enter drains. A novel method of reducing oligomer was pioneered in Japan, the concept of *alkali dyeing*. Oligomer is significantly more soluble in alkali liquors compared to acid, but the shade and other properties of disperse dyes can be influenced by alkali conditions. The Japanese were the first to develop a method of actually dyeing under alkali conditions to reduce the nuisance of oligomer. At the present time several dyestuff manufacturers now have products and recommended methods for alkali dyeing of polyester,<sup>12-14</sup> but care is needed as reduced abrasion resistance of polyester yarn can result. Also each dye must be individually screened for suitability for use in this method.

#### 4.2.7 Nylon dyeing

Nylon is dyed in a different way to polyester. Dyeing above the boil is not essential and acid dyes are used instead of disperse dyes. Only a certain class of acid dyes, metal complex – also called premetallized dyes – have the necessary high standard of lightfastness. As with polyester dyeing, dye mixtures are best made up from dyes which are compatible with each other. Recommended acid dyes for automotive fabric include selections from the Lanasyn (Clariant), Lancron (Ciba) and Neutrilan (Crompton and Knowles) ranges. There are more dyes to choose from compared to polyester dyeing but the premetallized dyes generally tend to be duller and darker shades.

The rate of dyeing of nylon is pH-sensitive, the rate being much faster under acid conditions. In order to obtain level dyeings, it is usual to start the dyeing under slightly alkali conditions and raise the temperature of the dyebath to the boil at a controlled rate. When most of the dye had gone on to the fibre it was usual to add acetic acid to lower the pH to exhaust the remainder of the dye. Nowadays there are now ‘acid donor’ chemicals which are alkaline, at the start of the dyeing, but break down as dyeing proceeds at about 80 to 100°C and release acid to lower the pH.

### 4.2.8 Acrylic dyeing

Acrylic is a synthetic fibre which is dyed with basic (cationic) dyes such as the Astrazone range produced by Dystar. Much acrylic fibre (made by Acordis, using the Neochrome process developed by Courtaulds) is spun dyed during yarn manufacture which produces dyeings of higher light fastness than those produced in an aqueous dye bath.

### 4.2.9 Wool dyeing

Wool can be dyed using the same premetallized dyes recommended for nylon. Wool processing especially needs environmental monitoring because of the amounts of oils or greases which may be present in raw wool. Wool, being a natural product, is more variable in its properties than synthetic fibres and cannot generally be 'blind dyed'.

### 4.2.10 Fabric scouring

For fabrics woven from dyed yarn, the scouring process not only removes residual lubricant and dirt from the fabric, but it is also an opportunity to relax the material and to develop bulk and texture. There are specialist machines available for processing delicate fabrics with very high levels of stretch but they can be very expensive. Woven fabrics are generally scoured full width on continuous scouring ranges to prevent creasing. Care and the correct apparatus are needed if the material is to relax according to specification, without stretching and destroying texture and residual stretch, which could be needed in a later process. The washing process is essentially controlled by four factors; mechanical aspects determined by machine design, chemical aspects, which means choice of the correct scouring agent and auxiliary chemical (e.g. to treat hard water), temperature of the water baths and time of treatment. In continuous scouring, time is determined by fabric speed. The chemical nature of the scouring agent is important because residual amounts may react adversely with finishing agents. For example a residual strongly cationic scouring agent may form white deposits with an anionic anti-static agent applied later to the fabric. Non-ionics or weak anionics are probably the safest scouring agents. Ideally the scouring agent must first enable rapid wetting of the fabric, followed by removal of soiling. The scouring agent should then hold the soiling in suspension and prevent redeposition back on to the fabric. Fabric drying on cans requires considerable care because the fabric can be stretched affecting dimensional stability and in extreme cases can cause glazing or loss of texture. Knitted fabrics are generally scoured in the dyeing machine before dyeing.

#### 4.2.11 Final stentering of fabric

This is a very important operation requiring much attention, and its importance is sometimes not fully appreciated. It is not simply an operation to dry off water and to put the material into convenient-sized rolls for handling. Final stentering is to produce fabric with the correct width, appearance and dimensional stability and must be carried out according to a carefully formulated standard operating procedure which takes into consideration all the processes the fabric will undergo after it leaves the finishing works. Final stentering imparts to the fabric the important properties of dimensional stability and the correct degree of stretch. These properties are developed by the amount of overfeed put into the fabric. However allowance must be made for the width and vice versa. Fabric pulled out widthways will tend to lose length, fabric stentered with excessive overfeed may be slack in the width. Dimensionally stable fabric with the correct properties are essential for efficient fabricating into panels for seats or other components as will be seen later in Chapter 6. The higher the setting temperature, the more dimensionally stable will the fabric be, see Fig. 4.7. Some automotive fabrics are not stentered at especially high temperatures because of the risk of shade change.

During the stentering process the fabric aesthetics, texture and pattern should be preserved. This is not easy when fabrics with checked designs or with lines down the length or across the width are being processed. The pattern is carefully examined at the take-up end of the stenter and any necessary adjustments to correct any ‘bow and skew’ should be made immediately. Distorted pattern is the reason for much rejected fabric, which can sometimes be corrected by restentering. Occasionally distorted patterns are noticed on laminated fabric during final examination; these cannot usually be corrected and so it is important to detect faults as early as possible and before further processing value has been added to the material. Very occasionally distorted patterns are noticed by the customer when the fabric has been made up into a seat cover – which is a disaster!

The stenter must be equipped with the appropriate equipment for controlling fabric especially when processing lightweight knitted material, which needs effective edge uncurlers and gum applicators. Clear instructions for simple operations such as stentering to the correct width must be made, whether the stated width is between the pins (usable width) or overall width including or excluding the ‘fringe’.

#### 4.2.12 Fabric finishing

There are very many fabric finishes available for textiles but very few are actually applied to automotive textiles. Some finishes have the side effect

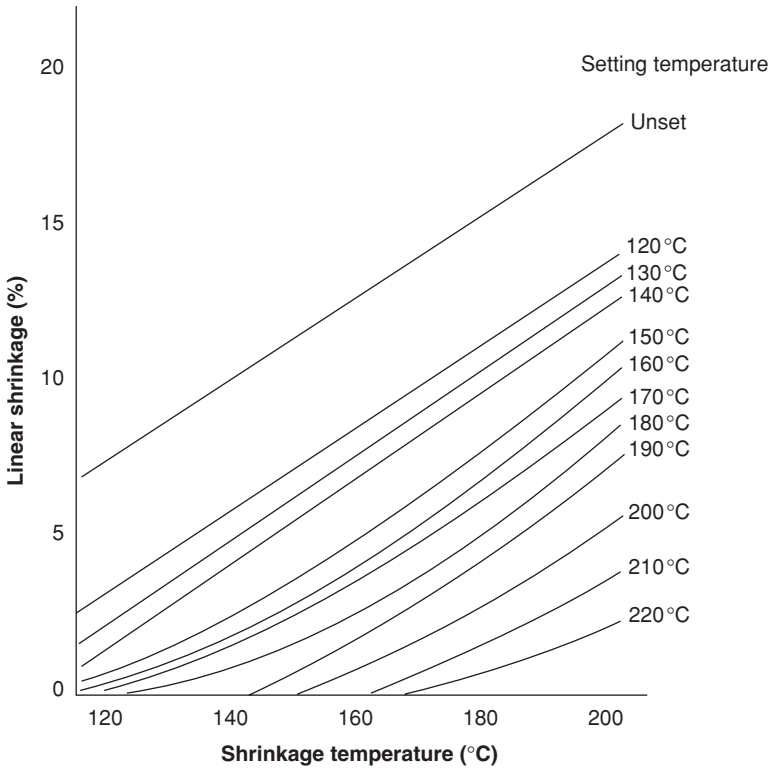

4.7 The effect of setting temperature on the dimensional stability of DuPont polyester fabric. Technical information from DuPont (UK) Ltd. (April 1999) and reproduced with kind permission. The higher the setting temperature the more thermally stable the fabric, i.e. the less shrinkage on reheating.

of reducing abrasion whereas others would cause fogging problems, give rise to white deposits, reduce lightfastness properties or otherwise affect colour. Many automotive fabrics have no finish at all applied. Some OEMs specify an anti-static finish, which is applied by dipping or full immersion on a pad mangle – a process usually described as padding or impregnation. Finishes can also be applied by a foam-finishing route which is more economical than padding, because less heat is required to dry off a reduced amount of water. Thus faster stentering speeds are possible and in addition there is no wasted residual chemical in a pad bath and therefore less effluent. Another important advantage is that the finish is applied to only one side of the fabric, the face side, because some finishes, notably soil release agents and especially silicones, reduce adhesion on lamination.

The foam-finishing process entails adding a small amount of foaming agent to an aqueous bath of the finish to be applied, at the concentration

Knife on air (floating knife)  
Knife or blade actually touches fabric

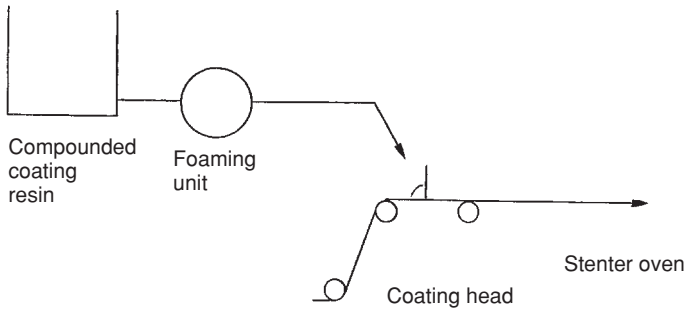

Knife over roller or table  
Knife or blade does not touch fabric  
There is a set gap between it and the fabric to determine resin add-on

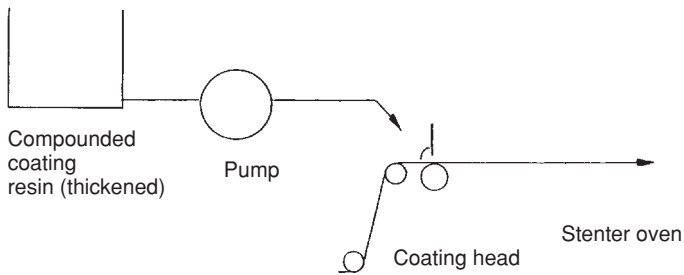

4.8 Fabric coating on stenter.

calculated for the required add on. The mixture is then put through a mechanical foaming machine and the foam is applied to the face of the fabric by a knife coating process. When foam processing is being carried out, the knife or blade normally touches the fabric surface, see Fig. 4.8. This procedure is termed 'knife over air' or 'floating knife', see fabric coating below. The foam density is such that it sits on the fabric surface without sinking into the fabric. The chemical add-on to the fabric is controlled by concentration of the chemical in the liquor, i.e. solids content and foam density (sometimes called blow ratio or cup weight). Blade profile, fabric speed and fabric surface condition and geometry will also influence add-on.

Anti-soil finishes with branded names, such as Scotchguard (3-M) or Teflon (DuPont), are sometimes specified by the OEM and these can be applied by the same methods of padding or by foaming. Soft finishes or flame-retardant finishes are hardly ever applied to automotive interior

fabrics because of fogging or other problems already mentioned, which could develop on the fabric over a period of time in the car. Flame-retardant chemicals are applied to automotive fabrics via a back coating, see below. Care is needed in formulating foam recipes otherwise frothing may occur during wet crocking and 'tide marks' may appear after drying. Also the amount applied needs to be optimized carefully. Too much can affect the shade of the fabric or cause stiffening, cracking or 'chalk marking'. There are fabric finishes developed to improve the abrasion resistance of fabrics which can be applied by padding or foam processing.

Foam processing should not be confused with the process of fabric coating, which is a similar process. The difference between 'foam coating', (also called foam finishing or foam processing) and 'fabric coating' is that the actual 'solids' applied to the fabric is, in the former case, the same as that added by a pad or impregnation route, i.e. 0.5 to 2% or less. Fabric coating applies considerably more, say 10 g/m<sup>2</sup> and much higher, usually as a visible layer to the back of the fabric. Foam processing is an alternative to padding or impregnation and where the finish cannot be seen. Only woven fabrics and some heavier weight knitted fabrics can be foam processed by this coating technique. Knitted fabrics, especially lighter-weight qualities intended for, say headliners are usually too stretchy and require more specialized apparatus such as a curved blade applicator.

### 4.3 Printing

The printing of textile substrates has been around almost for as long as textile fabrics, with evidence dating back 2000 BC. Printing of textile fabrics for automotive trim usage is, needless to say, somewhat more recent! Before describing the processes primarily used for automotive fabrics it would be useful to quickly review, and briefly describe, some of the many techniques used for applying a printed image to a textile fabric.

One of the earliest was block or hand printing where the flat surface of a block of wood was engraved with the design required to appear on the fabric left as a raised surface with the parts not required carved away. Upon completion the engraved part of the block was dipped in a colourant and applied under pressure to the fabric leaving an imprint of the design. By carefully applying the block print to line up with its neighbour top, bottom and side to side a complete coverage of the material is obtained and careful designing ensured that the pattern repeat could be disguised to appear much larger than it actually was.

Resist printing employed a similar technique of applying a printed image but instead of a dye or colourant a dye resistant substance was used (wax, clay, etc.) and the fabric was subsequently dyed with the dye failing to register where the wax appeared. This was then washed out leaving clear areas

of design on a dyed background. Clever developments of this technique allowed the process to be repeated several times to achieve multicoloured effects and have been successfully employed for centuries in such places as Indonesia where the process has become known as 'Batik' printing.

A further development of the Batik technique is 'Ikat' where the warp yarns are treated in a similar way and after dyeing and removal of the resist substance the warp is woven to create a very indistinct and it has to be said somewhat unrepeatable impression of the design. This Ikat principle is used today by printing the full design in all colours on the warp and then weaving. Very attractive effects are obtained in this way but the somewhat random and uncontrolled nature of the end result preclude it from becoming a serious process for automotive and in fact is yet another example of where the control and requirement for accurate repeatability, so much a feature of automotive production, preclude so many of the more creative and traditional textile processes being utilized.

Roller printing could be regarded almost as a development of block printing where the block is formed into a cylinder with the design being engraved on the outer circumference of the cylinder, producing a roller which is charged with dye liquor and rolled across the fabric surface leaving behind an impression of the design. This is shown in a simplified form in Fig. 4.9.

Roller printing is expensive due to the high cost of the metal rollers (usually plated copper etched with acid), delicate and slow engraving

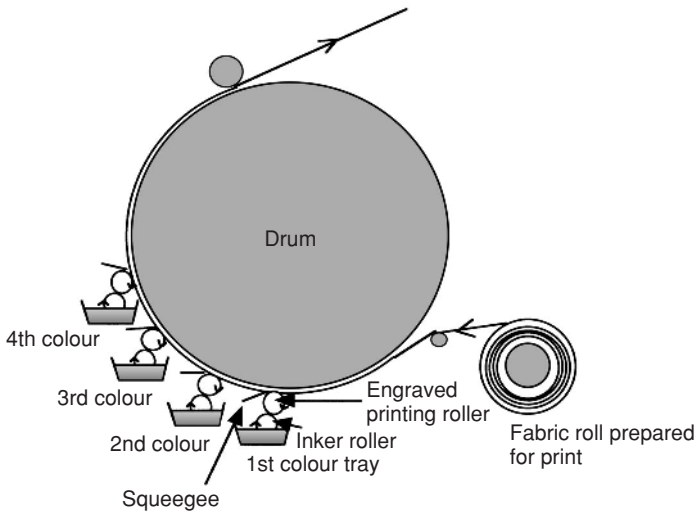

4.9 Simplified diagram of roller printing by engraved copper roller, showing set up for a 4 colour printed design.

process and high set-up costs demanding very high print runs for economy. However, it has a place in the production of very high quality and fine detail prints where large volumes are required per design and colour. The four main commercial printing processes which are relevant to automotive textile substrates are: flatbed screen, rotary screen, heat transfer, and the latest, and the one with possibly the greatest potential, digital ink jet.

### 4.3.1 Flatbed screen

In this technique the final design as perceived by the designer is separated into the constituent colours and each of these prepared as an individual design – this initial process is referred to as ‘separation’ and for a design composed of six colours would result in six individual designs being separated out prior to the next process. This used to be a highly skilled manual process but now the design is scanned into a computer and the colours automatically separated out and prepared as individual designs in exact register with each other so that if they were printed onto transparent film and laid exactly one on top of the other an exact reproduction of the original artwork would be seen.

Each of these separated designs is prepared on a flat screen which originally used to be of a fine silk material – hence the term ‘silk screen printing’, which is still used today, although nowadays the screen is likely to be of a synthetic material or fine metal mesh. The design is transferred to the screen by coating it with photosensitive material and exposing to light those areas which represent the colour to be printed. This degrades the coating and allows the exposed part to be washed out in the next process. One screen for each of the colours in the design is prepared in this way.

The screen covers the full width of the fabric and can be of varying length. Each screen is mounted in a frame locked into position above the printing bed, and the frames are arranged along the printing bed in the order in which the colours are going to be applied to the fabric. The fabric to be printed is temporarily stuck down to a printing blanket by thermally sensitive adhesive and transported by this blanket under the screens stopping for the screens to be lowered and the design printed.

The printing is done by introducing a viscous print paste containing the ink or dye of the desired colour onto the top of the screen and traversing the full width of the screen with a squeegee to force the dye paste through the screen areas, and onto the fabric. The fabric is then moved on and the next colour printed on top of the previous one, etc. until all the colours have been applied and a full colour-printed fabric reaches the end of the print bed and is peeled off the printing blanket to go through a dryer ready for the next process. A diagram of the process can be seen in Fig. 4.10.

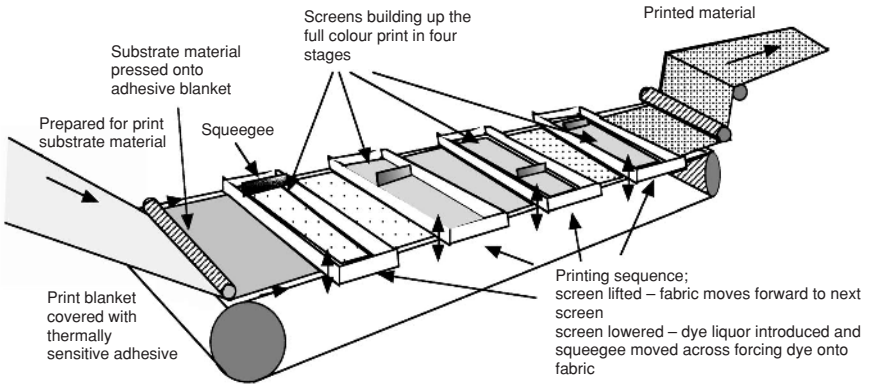

4.10 Simple diagram of flat-bed printing, showing main elements and sequence of the process.

Flatbed screen printing is a relatively slow but precise process which allows for fine detail in the design similar to an engraved roller but it has become expensive and rather uneconomic when compared with rotary screen printing. The problem of course is the fact that no matter how mechanized the process becomes, the fabric always has to stop to be printed.

#### 4.3.2 Rotary screen printing

In principle this is a development of flatbed. The flat screens have been replaced by hollow cylinders, the screen forming the outside perimeter of the cylinder and the dye liquor introduced into the centre of the cylinder and 'squeegeed' through the screen to the outside and onto the fabric. Like the flatbed screens the cylinders are arranged down the printing bed and the fabric is stuck down and transported down the bed but this time it is allowed to travel continuously and the cylinders or rotary screens revolve continuously, printing the individual colours in stages down the fabric until the full colour design has been built up. Figure 4.11 shows a simplified view of this. The speed of printing is vastly greater than for flatbed screen and the cost is of course lower for this reason, however the detail which can be obtained and the variety of substrates which can be printed is more limited so flatbed still holds an increasingly niche market in the printing of textile products.

The consistency of the dye paste for rotary screen is much thinner since it has to penetrate the screen much faster. With both systems it is essential for the individual screens to be in perfect register down the print bed so that the different colours are printed in exactly the right place on the fabric with no overlap of colour except where this is required as a specific part of the design.

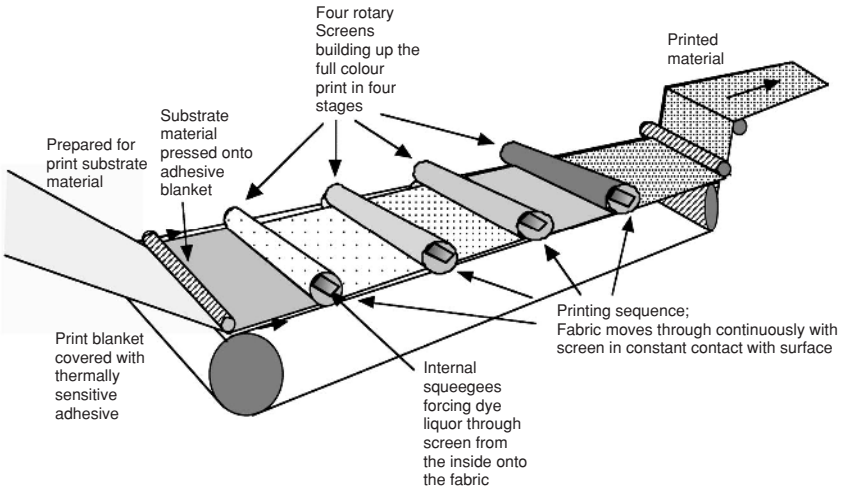

4.11 Simple diagram of rotary screen printing showing main elements and sequence of the process for a four-colour screen print design.

The overall principle of printing either by flat or rotary screen is the same and the formulation of the basic dye recipe is similar as are the additional processes after printing. This is of particular importance for the printing of automotive cloths, which are likely to be based on polyester fibres.

In order to achieve the required fastness to light on polyester, it is necessary to carefully select the dye stuffs used and also to fix these into the fabric at around  $130^{\circ}\text{C}$ . When package dyeing the yarn or fabric, this is done by processing under pressure in an enclosed cylinder. Of course, this is not possible when printing so the fixation has to be a separate process after the fabric has been printed. It is usual to wash off loose dyestuff immediately after the print process then transfer the fabric through a cabinet of superheated steam raising the temperature of the fabric to above  $130^{\circ}\text{C}$  for several minutes. This has the effect of driving the dye molecules into the fibres and developing optimum light fastness. Additional fastness is frequently obtained by mixing the dyes with a UV absorber of which there are several proprietary brands available. The final process would be to stenter out the fabric to the required width and roll up.

#### 4.3.3 Heat-transfer printing

This method came to prominence mainly due to its ability to print fabrics cheaply and easily on inexpensive equipment – only a simple calender arrangement is needed – plus the added advantage that the heat generated

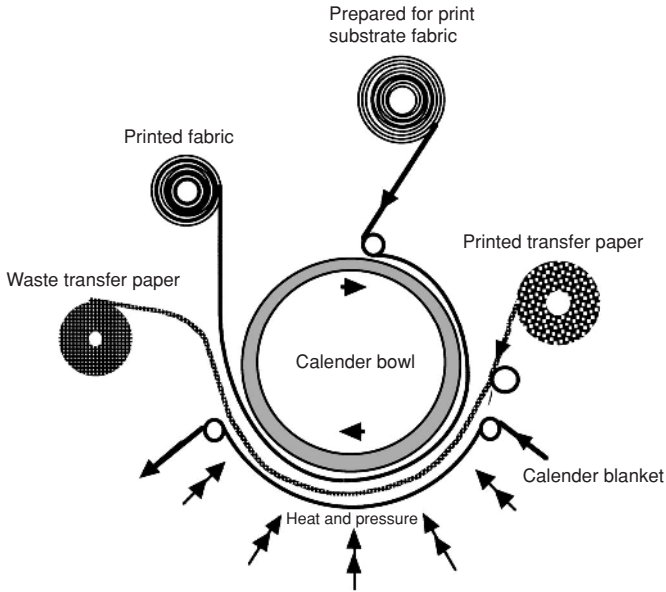

4.12 Diagram of a transfer printing machine used for polyester fabrics.

during the process made it very suitable for polyester fabrics which needed the heat to thermally fix the dyes into the fabric.

In transfer printing, the original design is printed in mirror image using disperse dyes selected for their ease of sublimation (i.e. ability to move from fixed to vapour form from one substrate to another under application of heat) onto special heat-resistant paper.

The paper and fabric are then pressed together in a rotary calender or press and the dyes sublime from the paper onto the fabric under the influence of heat at between 170 and 220°C. This produces a mirror image of the paper design on the fabric in great clarity and detail since no liquid phase is involved; furthermore, due to the heat the dyes are firmly fixed and display maximum lightfastness. The process is economic with short runs and is also able to print dimensionally unstable fabrics such as knits. The process of printing the papers prior to printing the fabric is the preserve of specialist transfer-paper printers.

With all these advantages particularly for printing polyester fabrics – the staple diet of automotive trim – it is a valid question to ask why it has not been massively exploited in this area. There are, as you may expect, a few key disadvantages – colour repeatability to the fine tolerances required in automotive materials is difficult – the pressure means that any fabric with any sort of surface pile or nap will be flattened and almost all fabrics will

change appearance and handle. This aspect has proved to be a great limitation with regard to the number of fabric types which can be processed successfully for trim, although the process has been and still is used particularly for applying colour and design to headlining fabric and other areas where there is some wider tolerance in terms of aesthetics and handle. A simplified diagram of the process is shown at Fig. 4.12.

#### 4.3.4 Ink-jet printing

Flatbed and rotary screen printing are basically fairly old technologies which are still used to print automotive fabric and both these methods are usually carried out by specialist printing companies who have invested the considerable amounts of money required in the capital-intensive print machines and after-processing equipment. However a lot of development effort is now invested in a process which has the potential to totally reverse this situation and that is digital ink-jet printing.

Ink-jet printing itself has been around for many years but has been largely confined to the graphics industry and to a limited degree carpet printing (Millitron<sup>®</sup> process is an example of this) where fine definition of design is not vital to the product.

The printing of textile substrates by ink jet has been carried out for several years in the production of single one-off panels for approval of design and colour prior to the engraving of screens but with recent developments of wide-width, ink-jet printers and the massive advances in computing power and speed, fine detail printing at 360 dots per inch and more can be carried out on a continuous basis albeit very slowly in comparison with rotary screen printing.

An ink jet printer is essentially composed of an ink supply, print head, a drive mechanism which propels the print head horizontally across the fabric width somewhat reminiscent of the shuttle, a continuous cloth feed arrangement and of course a CAD system which not only allows the design to be created but also drives and controls the print heads and colour mixing. Many such wide-width printers are available, some developed by the traditional screen printing machine manufacturers and totally dedicated to printing textile substrates, and some developed by the graphic printer manufacturers such as Epson, Hewlett Packard, Encad, Innotech etc. which have been modified to take textile instead of paper substrate.

There is a fundamental difference between ink jet and conventional printing in that ink jet uses what is known as 'process colour' to create the effect on cloth where each colour is a combination in varying proportions of cyan, magenta, yellow and black (CMYK) which are only mixed to create the required colour effect when they actually hit the substrate from the ink jets.

Conventional printing on the other hand uses what has become known as 'spot colour' where the actual final colour required is premixed in a colour kitchen before printing. This means that the range of colours available as 'spot colours' is almost limitless and when they are printed they are effectively 'pure' colour with great clarity. 'Process colours' on the other hand are much more limited both in their range and also the sharpness and clarity when printed out. Developments are in hand to improve this by increasing the standard four CMYK inks to intermediate shades up to eight or more each with its own jet and combining blocks of jets to operate as one, this is known as 'super pixel' technology and it produces greater freedom to match colour requirements since colours can be premixed in a similar manner to 'spot colours' to better match design colour needs. It currently has problems with small jet nozzles and is not an ideal solution for the graphics application where very high resolutions are needed but has possibilities for textiles where print resolutions can be much lower to match existing screen print.

Development is ongoing and the approach taken for textiles has varied from company to company. The traditional manufacturers of such machines, coming from a graphics background where high print resolution has been the driving force, have tended to assume that this would also be a key requirement for textile substrates and have adapted existing machines to take textile fabrics. This has sometimes meant that fabrics have to be coated or laminated to create an even surface – not an ideal situation and much more relevant products will have to be developed for this end use.

Other manufacturers, such as Stork and Zimmer, coming from a background in textile printing have realized that machines have to accept many different fabric substrates and that high printing speed to keep production costs down would be an important factor. Since this is more easily obtained at lower print resolutions (not as many jets to feed with ink and information from the computer) development effort now is considering more closely matching the ink jet with the existing resolution of screen print and, in fact, possibly varying the print head according to the resolution and substrate to be processed – a very fine silk chiffon is likely to require far different treatment from a coarse velvet coach fabric in terms of design definition or resolution.

The basic hardware requirements and possible configuration for an ink-jet printing set up are illustrated in Fig. 4.13. However, irrespective of the origins of the printer the key element is the print head and this is usually of three main types as illustrated in Fig. 4.14. They are: continuous drop deflection where a continuous flow of droplets (over half a million per second) from each jet is directed at the fabric and when not required, is deflected away; drop on demand thermal (e.g. thermal ink jet as produced by Canon and Hewlett Packard) where the ink is heated up to 300 to

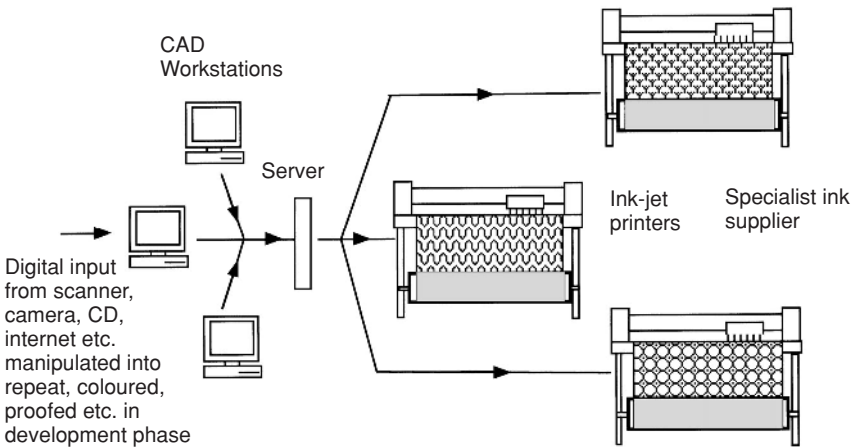

4.13 A possible configuration for the digital printing of textile substrates.

400 °C to form a bubble which explodes and propels the ink onto the surface of the fabric; and drop on demand Piezo electric (e.g. Epson printers) which applies an electric charge to a piezo crystal which expands a diaphragm in the ink well causing a mini explosion that forces ink drops from a jet. The sort of wide-width printer which would house the print heads is illustrated in Fig. 4.15.

Whichever system is used the method of building up the design and colour is essentially different from the traditional methods in that the different colours on the fabric are built up by mixing dots of pure CMYK colour on the surface of the fabric. This has been referred to earlier as 'process colour' compared with the 'spot colour' of traditional screen printing where the individual colours are mixed to the correct shade *before* applying to the fabric.

There are many issues to address using ink-jet systems, one being the development of suitable inks and colourant dyes which do not clog the jets – particularly important for polyester where disperse dyes comprising fairly large dye particles are concerned. Another and fundamental issue is the development of the CAD software package to produce the design to control the jets and to mix the colours to fine limits to realize and control the exact colour required for each element of the design. In other words to decide how many dots from each of the jets will be required to create the final colour on the cloth.

Both these issues have received a lot of attention from such companies as Du Pont, CIBA, BASF etc. who manufacture the inks and dyes and Sophis Systems, who are headquartered at Wevelgem Belgium, and have

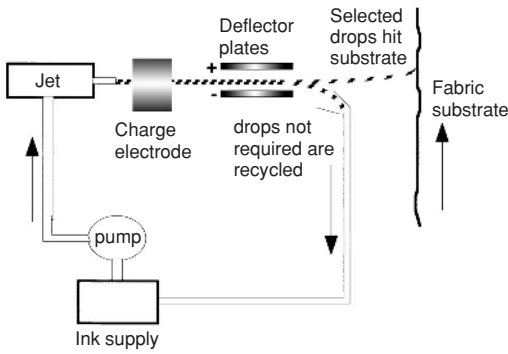

**Continuous inkjet drop deflection technique.**  
 A continuous stream of drops is fired at the substrate and given  $\pm$  charge by electrode. Drops not required are deflected by  $\pm$  plates and recycled

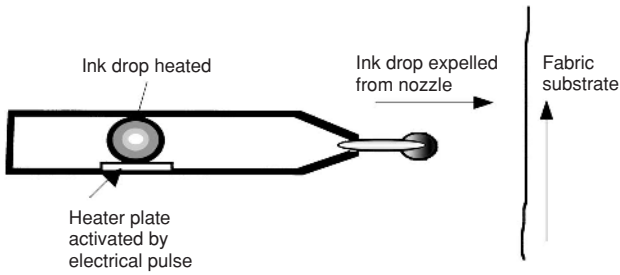

**Drop on demand – thermal**  
 Ink drop heated to  $400^{\circ}\text{C}$  in millisecond and expands to form vapour bubble. It is expelled through nozzles and hits fabric as a droplet

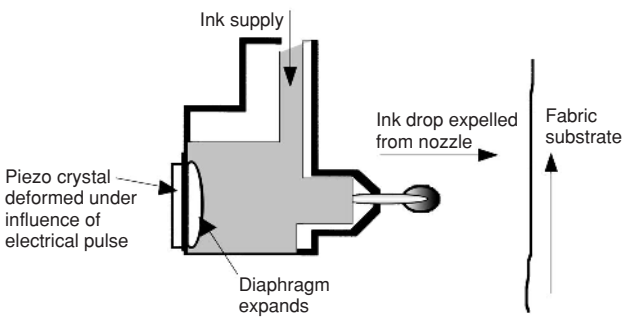

**Drop on demand – piezoelectric crystal**  
 Diaphragm expanded under influence of piezo crystal and displaces ink out through the nozzle as droplets which deposit onto the fabric

4.14 The three main types of ink-jet printing heads, illustrating the principles involved in propelling the ink drops onto the substrate material.

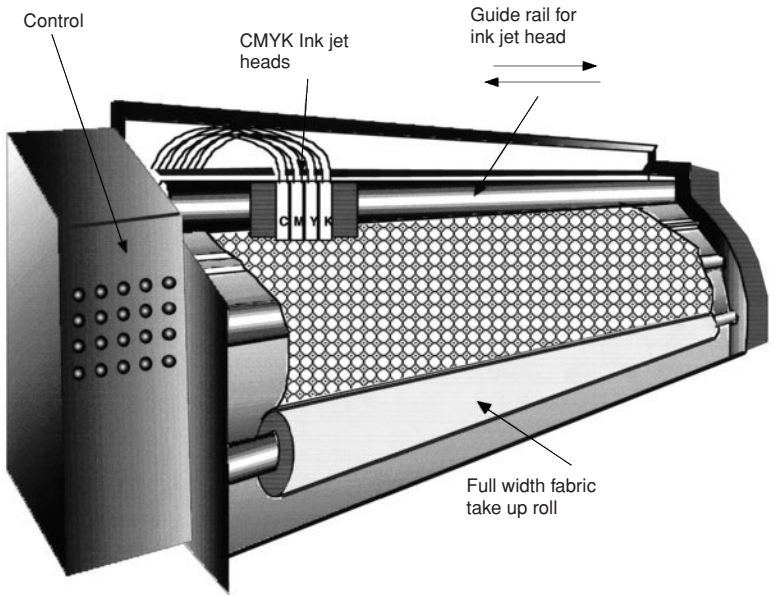

4.15 Diagram of wide-width ink-jet printing machine adapted for the continuous printing of textile substrates.

spent many years perfecting the CAD systems necessary to drive the design elements of the process.

Following the printing process it is necessary to wash off and, in the case of polyester, fix the dyes into the fabric to obtain the necessary lightfastness. This is done in ways similar to those employed following rotary or flatbed screen printing. It has to be borne in mind, however, that the continuous ink-jet printing of textile products, particularly automotive materials with its preference for polyester, is, on a world scale, in its infancy but companies such as Seiren in Japan have currently taken a lead in the application of the technology to automotive substrates.

A lot of attention is being focused on the process mainly due to the advantages it offers in terms of ease of design and colour change with minimum down time, and responsiveness to what has become known as 'agile manufacturing'. This is the ability of a process to respond quickly and efficiently to short-term demand based on sales patterns and volume requirements and is particularly relevant to the automotive scene where design and production and the need to differentiate models is becoming increasingly short term and complex.

These advantages however are balanced by the slow production and the totally new organization required to make a success of this form of printing. No longer is it necessary to involve commission printers to print

large volumes from a few hugely expensive machines installed in a central print works. Rather it offers the possibility of installing many ink-jet printers controlled, via a CAD system, by the fabric producer and similar in concept and production rates to the manufacture of jacquard-woven fabrics.

Ink-jet is the only true noncontact method of applying surface pattern to substrates and this fact alone offers many advantages for textile producers, particularly those involved with pile products or any fabric which has a sensitive surface such as artificial suede, etc. Since the print heads never actually come into contact with the fabric surface no disturbance can take place due to the actual printing process and the ink can be made to penetrate into the pile surface without any necessity to apply pressure and flatten any specific surface effect.

Further development of control systems of the fabric relative to the print heads offers the potential to locate colour on specific parts of the fabric to within fine tolerances which could mean that jacquard woven or knitted designs in ecru fabric could be printed with colour located on the actual design area imitating colour weaving or knitting but without the large yarn inventory and the extended lead times this involves.

Ink-jet is an emerging technology which is largely computer driven, where development is traditionally very fast and which has huge potential in the production of figured automotive trim fabrics and transportation fabrics generally. It also offers the possibility for existing fabric producers to become involved in a small way and grow as experience and knowledge are obtained. One company, The Seiren Co Ltd., Fukui, Japan, have done just that with their Viscotecs® system.

Whether this potential will be fully realized world-wide will depend on many factors, of which mastering the technology and optimizing production speeds, print resolution, physical properties, colour consistency, range and repeatability, are but a few.

## **4.4 Coating and lamination**

### **4.4.1 Fabric coating**

This section is concerned only with the coating of automotive fabrics, more general information is presented in Chapter 9. The definition of fabric coating is usually accepted as the application of a polymer or resin to one side of a piece of fabric. A simple analogy is spreading butter onto toast. The modern coating industry dates from the early nineteenth century, when Charles Macintosh made the first rubber-coated fabric. His name became synonymous with the raincoat. Automotive fabrics are coated for a number of reasons, the two most important being to improve abrasion resistance

and secondly to confer some flame-retardancy (FR) properties. Early heavy knitted automotive fabrics were coated to control fabric stretch. Other properties, which can be imparted by coating include high frequency (HF) weldability, by application of a PVC latex, and barrier properties to liquids. The higher the amount of coating applied the better the barrier properties. However, fabric handle can be stiffened significantly by coating especially if the coating resin applied is not chosen carefully. Fabrics are also sometimes coated to modify stretch and to control porosity. In general only woven fabrics can be easily coated by the usual methods – knitted fabrics are generally too stretchy and dimensionally unstable. Having stated this, it is believed some heavy-duty knitted fabrics are sometimes back-coated to reduce excessive stretch. Woven velvet fabrics must be coated to lock in the pile.

Polymers applied are generally water-based acrylic, polyurethane or PVC lattices. Acrylics are probably the most versatile and are used the most. Polyurethanes are a little more expensive but generally have better stretch properties. The polymers are mixed with water and other ingredients such as thickening agents, foaming agents, fillers for economy and when necessary, FR chemicals. The whole mixture is referred to as a compounded resin. Sometimes extra cross-linking agents, wetting agents and other specialist additives are also included. The compound is mechanically foamed by high speed agitation and air pumped in to give a foam of a predetermined density usually about  $0.2\text{ g/cm}^3$ . This compound is pumped on top of the fabric reverse side up, in front of a doctor blade in front of a stenter. This particular method of fabric coating is referred to as the 'direct method' and there are a number of variations. When the doctor blade or 'knife' actually touches the unsupported fabric, see Fig. 4.8 it is referred to as a 'floating' knife and the method 'knife on air'. When higher levels of polymer are applied, the fabric is supported by a table or roller and a finite gap between the blade and the supported fabric is set using a feeler gauge. The size of the gap is another factor which determines add-on. This method is referred to as 'knife over roller' or 'knife over table'.

The same factors that already have been mentioned in foam processing control compound add-on. Motion of the fabric forwards into the stenter oven spreads the foamed coating evenly onto the surface of the fabric. On drying under the action of the stenter the foam collapses and an even coating is obtained on the back of the fabric. Foaming is necessary to prevent the compound wetting and sinking into the fabric and penetrating to the face side. This method is excellent for applying relatively low additions of resin, say up to about  $30\text{--}40\text{ g/m}^2$ . When much heavier weights need to be applied, the compound is not foamed but thickened with a thickening agent. This has the same effect as foaming, allowing the resin to sit on

the surface of the fabric without sinking in, and penetrating to the face side. Resin penetration can lead to fabric stiffening and chalkmarking or other appearance problems. Both foam processing and foam coating can also be carried out using rotary-screen techniques, which have certain benefits such as allowing certain knitted fabrics to be coated by the direct method, but which entail more expensive plant.

#### 4.4.2 Introduction to lamination

Lamination is the joining together of two materials, and is one of the fundamental processes in the production of car interior trim. Usually a third material is used as the adhesive, but sometimes one of the materials being joined can itself act as the adhesive as in flame lamination. There are four main groups of mechanisms by which adhesion is believed to take place.<sup>15</sup> These are: mechanical interlocking, diffusion of polymer molecules across the interface, electrostatic forces and finally interatomic and intermolecular attractions between the atoms and molecules of the materials being joined, i.e. the adhesive and one of the substrates. The adhesive acts as a 'go between' between the two substrates being joined together. The last-named group includes chemical bonding, which generally produces a strong and durable bond. All types of bond require clean surfaces that are free from dirt, grease and other contaminants especially silicones. Increasing the surface roughness generally improves the bond strength. When bonding problems with films and plastics are experienced, surface treatment of the film or plastic with corona discharge or a plasma process sometimes help. Chemical cleaning or pretreatments with flame are also reported to be helpful.

Mechanical interlocking, especially with rough, natural, short-filament fibres such as cotton, is an important means of adhesion. Much development has been necessary to improve the bonding of rubbers and plastics to smooth continuous filament synthetic fibres. In automotive applications, high production rates are the norm and material handling considerations are just as important as the actual joining process. Feed systems for fabrics, foams, films and other materials to be laminated at high speeds present logistic problems and other limitations, which are common to all methods of joining. The lamination process must not affect the appearance, colour or surface texture of the fabric being joined and should have minimum effect on the handle of materials especially those that are to be used for further processing. Thus adhesive must be controlled: it should first 'wet' and flow on the surfaces of the materials being joined, penetrate to a certain extent but not such that it will cause stiffening or penetrate through to the fabric or material face.

### 4.4.3 Types of adhesives

Adhesives are available as solutions, as dispersions in water or solvent or as solids, which melt under the action of heat. All adhesives must have some affinity for both the materials being joined. As just mentioned above, they must first of all 'wet', cover and penetrate the surfaces to be joined and then solidify by evaporation of the carrier liquid to form the permanent bond by the mechanisms already mentioned. In the case of a 'hot-melt' adhesive, the bond is formed on cooling. Hot-melt adhesives are available in several forms; as a 'web' (resembles a net curtain), as a continuous film, or in powder or granular form. Some adhesives are also available as a liquid or jelly which are 100% (or nearly) active material and do not contain any solvents or water.

#### 4.4.3.1 Solvent- and water-based

Solvent-based adhesives are generally environmentally unfriendly, and safety precautions must be taken because many are flammable and their fumes can be harmful to health. In addition solvents are more expensive than water but in general, solvent adhesives 'wet' the surfaces to be joined better than water-based adhesives, have more 'grab' and they also dry off faster. Shelf life is reported to be generally better than water-based, because the organic ingredients disperse better in a solvent, compared to water. Water-based adhesives are safer to use and pose less of a problem to the environment, but drying of water can be expensive both in terms of energy and time.

#### 4.4.3.2 Hot-melt adhesives

Because of the factors stated above, hot-melt adhesives are gaining in popularity but they need to be carefully selected. For good durability their softening and melting point must be well above the temperature to which they will be exposed inside the car. Other performance factors, which must be considered in common with all types of adhesive are, bond strength, resistance to moisture, humidity, heat ageing, light and UV degradation, and any effect on fabric colour. The nature of the materials to be joined, where they will be used within the car, and their physical form, all need to be taken into consideration when deciding which adhesive, and which lamination machine to use.

Choice of hot-melt adhesive affects the handle because of two reasons. The first is the physical property of the adhesive material itself, i.e. if it is hard or soft, and secondly the degree to which it sinks into the fabric. The melting characteristics, flow properties and viscosity of hot-melt adhesives

are important considerations. If too much heat is applied they can flow away from the surfaces to be joined and hence produce a poor bond. This excessive flow may also cause stiffening of the laminate and penetration to the face of the fabric being laminated. The adhesive manufacturers offer advice on which chemical class of adhesive to use, and the best particular one for the job in hand. They should also have information on adhesive properties including recommended temperature of bonding, heat resistance, resistance to water, and solvents, etc. Manufacturers should also be able to advise on resistance to PVC plasticizer migration, when PVC is being joined, and have information on adhesive viscosity at the recommended bonding temperature. Of course it is always sensible to get at least a second opinion, and to carry out impartial trials. The manufacturer being consulted may not actually sell the best product or even the best chemical type for the job. They may judge that it is not in their best interest to recommend a competitor's product!

Chemical types include polyethylene, polypropylene, (the two chemical types merge and are often referred to as polyolefin), polyamide, polyester and polyurethane. There are copolymer varieties of each chemical type allowing a wide range of properties including melting points and heat resistance to be obtained. Polyolefins tend to be the most economical but tend to have lower durability. The polyurethanes tend to be the most expensive but they are capable of giving softer, more flexible and stretchy laminates.

Adhesives in film or web form are generally significantly more expensive than corresponding adhesive powders. Continuous film adhesives cause stiffening which may not be a problem in the case of say headliners. Slit films, which reticulate on the application of heat, are available, e.g. Sarna Xiro films. These allow a more flexible handle as do adhesive webs or powder. Adhesive powders are available in all the chemical types and also in particle sizes ranging from very small, up to about 500 microns or so in diameter. The choice of size depends on a number of factors including the machinery available, the surface nature of the substrates and the handle and properties required. There are a number of processes by which hot melts can be applied, each with its own merits, see Fig. 4.16.

#### 4.4.4 Materials to be joined

The largest volume material in the car interior is the car seat cover which is a triple laminate made up of polyester fabric joined to polyurethane foam with a thickness of anything between 1 and 10mm, with a scrim fabric on the back. Door casing and headliner fabric is also laminated to polyurethane foam to provide a soft touch, but a scrim fabric is not generally needed. A variety of methods is used in door panel assembly with textiles being used in combination with plastic foils in polyurethane, PVC,

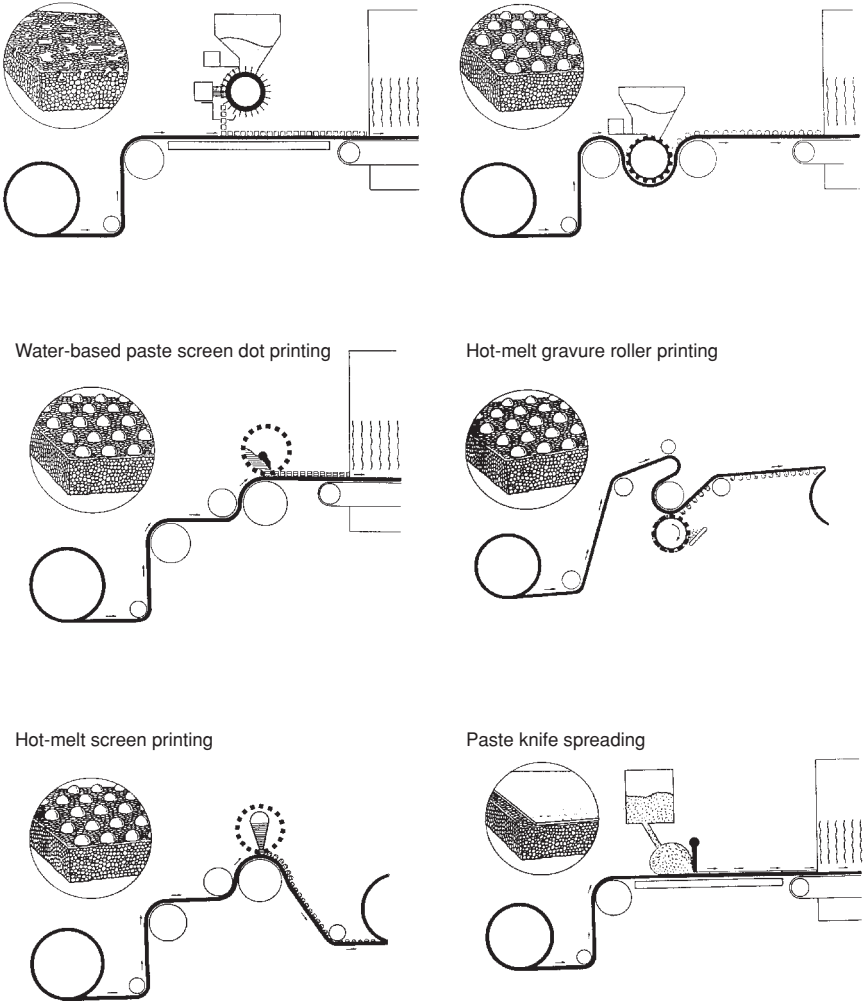

4.16 Hot melt adhesive application methods. Diagrams reproduced with kind permission of EMS-Chemie AG Switzerland. The hot-melt screen printing and hot-melt roller printing methods require a screw extruder to melt the powder and deliver the melt adhesive to the coating head. Diagrams reproduced with kind permission of EMS-Chemie AG (Switzerland).

PVC/ABS and polypropylene; textile/leather combinations appear in up-market models. Solvent spray adhesives are still widely used with 100% solids hot melt coming into use. Some manufacturers make use of pressure-sensitive adhesives, which are clean and require no heating or drying and no special safety apparatus such as extraction units or spray booths. The nature and texture of the materials being joined, the performance required

plus the plant available, all have an influence on which adhesive and which adhesive type to use.

The following factors must be taken into consideration:

Chemical nature of substrates to be joined i.e. polyester, PVC etc.

Physical condition i.e. texture, pile and surface nature – will it be damaged, especially by hot-melt processes?

Fabric construction, open or relatively closed – will adhesive penetrate?

Fabric stability – how it will affect handling – is stretching or shrinkage likely to occur?

Presence of fabric finish or residual lubricant and possible effect on adhesion.

Temperature resistance required of the resultant laminate.

Initial bond strength specified.

Bond durability, i.e. resistance to water, high relative humidity etc.

Plasticizer migration (of PVC components).

UV and light resistance (if applicable).

Possible effect on appearance, e.g. discoloration of face fabric.

#### 4.4.5 Flame lamination

The process in widespread use throughout the world is flame lamination, which was actually invented in the 1950s and extensively developed commercially in the 1970s. This lamination method makes use of the polyurethane foam itself as the adhesive and is a quick, economical process. All three components, face fabric, polyurethane foam and scrim fabric are fed into the laminator and the three materials, joined together, emerge at speeds between 25 to 40m (or more) per minute. A gas flame licks and melts the surface of the moving foam, which then acts as the adhesive to the fabric, which is laid over it. This happens twice in a double head machine as shown in Fig. 4.17. To compensate for the foam burnt off, input foam slightly thicker than that specified must be used. Headliner and door casing face fabric is generally produced in the same way but without a scrim – a bilaminate. It is possible to flame laminate polyester face fabric to a polyester non-woven material (polyurethane foam substitute), using ‘mini’ foam, i.e. polyurethane foam about 0.5 to 1 mm thick. The foam adhesive is virtually all burned off, but some readers may hold the view that this practice is not satisfactory because one of the objectives of using non-woven fabric is to replace polyurethane foam and remove the need to flame laminate!

Machine settings controlling flame temperature (gas/air ratio), burner distance, gap separation of the rollers and speed must be optimized for each quality of foam and fabric being laminated. Flame-retardant grades may

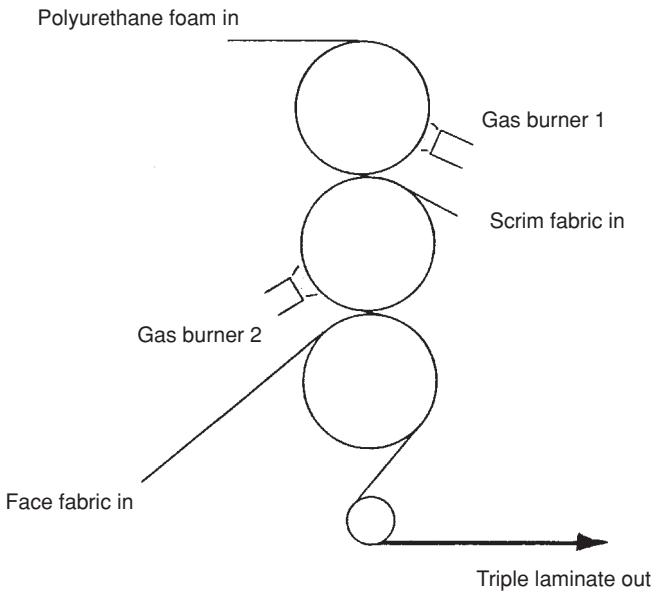

4.17 Flame lamination. The gas flame from burner 1 melts the surface of the foam, which then acts as the adhesive for the scrim fabric. On the other side, burner 2 melts the other surface of the foam, which then acts as the adhesive for the face fabric. Thus three separate materials are fed in and a single triple laminate emerges.

need more burn off to produce a satisfactory bond. Originally polyether polyurethane foam could not be bonded well by the flame lamination process but the foam manufacturers have modified it and it can now be bonded just as well as polyester polyurethane foam, although different machine settings may be needed. The two types of foam, which are both polyurethanes, have slightly different properties, the main one being that polyether polyurethane foam has better hydrolysis resistance than polyester polyurethane foam. The former variety is better suited to more tropical regions of the world and is specified by some OEMs. The two terms sometimes cause confusion, especially when for brevity they are referred to as simply 'ether foam' and 'ester foam'. They are both polyurethane foams.

The flame lamination process has come under environmental scrutiny in recent years,<sup>16,17</sup> because it produces potentially toxic fumes by the burning of polyurethane and alternative methods have been developed using hot melt adhesives.<sup>18-21</sup> However the cost of controlling the emissions is, in many cases covered by the economies of the process and certain large volume operators have chosen to continue to operate flame laminators.<sup>22,23</sup> They

have installed effective fume control equipment such as carbon adsorption which has satisfied the environmental authorities. Flame lamination produces a flexible laminate with high bond strength and without affecting the aesthetics of the fabric in any way. A particular requirement of laminated fabric for car seats is the ability to form both concave and convex curves without 'cracking'. In-put tension control needs to be controlled very carefully for the laminate to be uniformly dimensionally stable and to have the ability to lie flat on the cutting table. Panels cut from the laminate must keep their shape and not distort under differential tensions within the material itself because of the substrates, foam in particular, being joined in a stretched state.

#### 4.4.6 Flatbed laminators – calenders

When the issue of flame lamination being an environmentally unfriendly process arose, thoughts first turned to calenders and the hot-melt adhesives, which had been used in the garment industry for many years. The calender principle is that a sandwich is made of the two materials being joined with a hot-melt adhesive film, web or powder in the centre. This is then fed into the calender which heats the materials and melts the adhesive to produce a laminate. Webs or films are only available at fixed weights and widths but if volumes are sufficiently large, the suppliers will normally supply any width required. Much higher volumes are required for webs or films to be specially made at a particular weight. The advantage of powder is that it can be conveniently applied at any weight, and at any width for both short and long production runs of fabric.

Calenders are usually heated electrically and transfer of heat by conduction is not as rapid as say in a textile stenter. The goods being processed take heat out of the machine and heat is being lost all the time to the surroundings. Because of this bond strength should be checked frequently in a production run. The important temperature is the 'glue line temperature', i.e. the actual temperature in between the two substrates where the adhesive actually is, and not the temperature on the machine control panel. Depending on the thickness of the substrates and machine speed, this temperature could be 20–30°C higher than the glue line temperature and the adhesive not being melted, see Fig. 4.18. Heat-sensitive paper is available to determine the actual temperature at the glue line.

Optimum heater temperature, height adjustment, pressure and speed settings, must be established by thorough trials to determine the best conditions for producing laminates of the right quality at the maximum speed for commercial production. Modern machines accurately record all processing conditions and can be computer controlled. Conditions that are too mild will not effectively melt the adhesive and produce the required bond

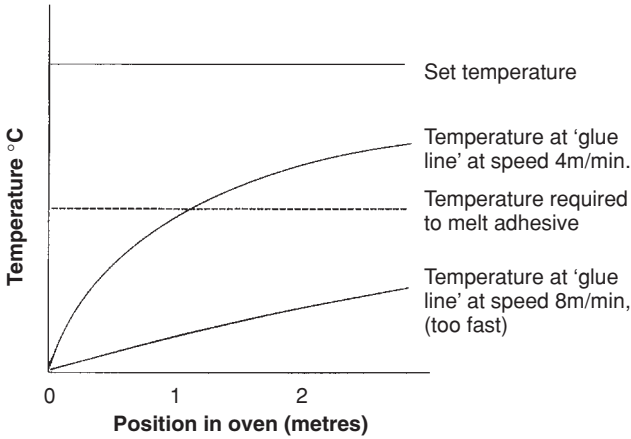

- 4.18 Calender/flat bed lamination. Contact heat. At speed of 8 m/min bonding does not take place because the adhesive never reaches its melting temperature. The correct balance of time and speed determines the 'dwell time', i.e. the time actually in the heating zone. This must be optimized. The set temperature may be hot enough to damage the goods if the machine stopped or is operated too slowly. Heat-sensitive indicator paper is necessary to determine the actual temperatures attained at the 'glue line' and at the surface of the goods.

strength, whereas conditions that are too severe could damage the fabric appearance by glazing or by flattening pile or texture. Viscosity of the molten hot-melt adhesive is important because at the bonding temperature, it must flow to cover a certain amount of substrate area and 'key' into the substrates being joined.<sup>24</sup> If it flows too much it will strike through the substrates causing stiffening and in extreme cases flow away from the surface, hence resulting in a poor bond, see Fig. 4.19.

Calenders are available from several manufacturers with different designs, e.g. different layout of heater zones and heater arrangement, some with cooling inside the machine, others with the cooling unit outside. Much thought has gone into the design to enable them to produce quality laminates at commercial speeds. The main drawback of the calender method is that the heat is supplied to the hot melt adhesive *via the substrates themselves*, which could be prone to damage by heat, especially fabrics with textured yarns or with a pile. This is aggravated by the fact that when the two substrates are nipped together to form the bond, they are both hot. Moreover, the materials most often being joined in the automotive textile industry, textured polyester fabric, non-woven materials and polyurethane foams are also good *insulators* of heat and so the process is quite slow. The 'open' lamination method shown in Fig. 4.20, being used for substrate S3, is best

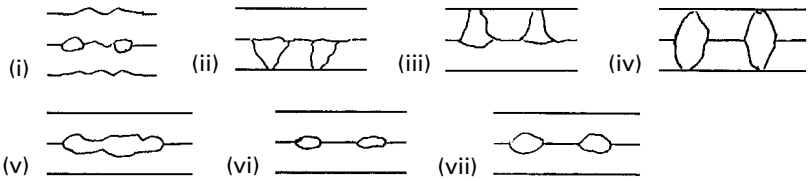

4.19 Fusing problems associated with powder hot-melt adhesives. (i) Substrate distortion, shrinking. (ii) Strike through base substrate, sticking to belt or roller. (iii) Strike through top substrate, sticking to top belt or roller. (iv) Strike through both top and bottom. (v) Powder joining together causing stiffening. (vi) Insufficient penetration and melting – poor bond. (vii) Correct bonding. Reproduced with kind permission from EMS-Chemie AG Switzerland.

for especially thick materials – if the equipment is available. Infra-red heaters are used to heat the adhesive but they should emit radiation of the optimum wavelength so heat is absorbed irrespective of the colour of the substrate.

To minimize damage to the texture or raised surface of pile fabrics, the top belt on some calenders can be set to a precise distance from the bottom belt. This facility of being able to set a gap between the belts is also useful to reduce loss of thickness by crushing which can occur especially when pressure is combined with heat. However, having said this, both polyurethane foam and thick non-woven fabric materials, (as has already been noted), are good insulators of heat and some compression is necessary, for rapid heat transfer. Polyurethane foam is likely to recover, but non-woven fabric may not – depending on the temperature and pressure applied and this must be checked beforehand, see Table 6.1. Any number of layers of material can be joined simultaneously provided a multiple feed system is available, but the limiting factor is likely to be speed, because heat has to penetrate through all the layers to reach the glue line to activate the hot-melt adhesive. Generally the choice is low-temperature machine settings to preserve material properties and low production speeds – or higher temperature settings for higher production speeds with the risk of thermal damage to the fabric or other substrate. High temperatures may also produce unsatisfactory results because of thermal shock, shrinkage of the goods and strike through of adhesive.<sup>24,25</sup> Long heating zones such as those on the newer Reliant calenders allow lower temperatures to be used for more gradual and gentler heating overcoming these problems and, also allowing reasonable production speeds.

Calenders, also referred to as flatbed laminators, are used extensively for headliners and other textile automotive components because several layers of materials, each with an adhesive layer in between can be joined with one

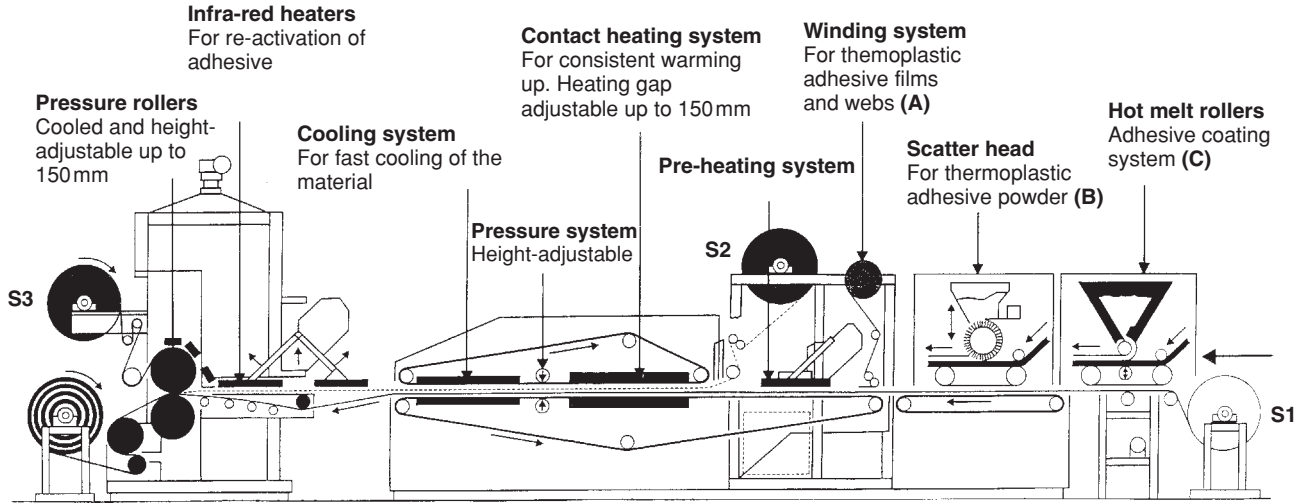

Re-activation of hot-melt adhesive by Infrared heaters and lamination using external pressure rollers. Substrate 3 is heat-insulating or heat-sensitive material, not suited to contact heating.

Calender heating zones temperatures, height adjustment, pressure roller gap, pressure and speed settings computer controlled.

Three different adhesive application methods.  
A. Adhesive film/web  
B. Powder scattering  
C. Hot-melt roller.

4.20 Schematic representation of lamination of three substrates in a single continuous process using three different hot melt adhesive types. Reproduced with kind permission of Maschinenfabrik Herbert Meyer GmbH.

pass. The use of calenders is not an alternative to high volume flame lamination for seat covers or other fabric/foam joining operations because of the relatively slow speed. Calenders can be used for laminating non-roll goods, such as leather hides to foam and for small scale production lamination. They are especially useful for development and preparation of samples, when anything from A4 size pieces to thousands of metres can be conveniently produced. Belt joins may produce a mark on the goods, which can sometimes be overcome by balancing the conditions of temperature and pressure. Belts with very flat joins are available but the most satisfactory remedy is use of continuous belts which have no join but these are considerably more expensive than joined belts.

#### 4.4.7 Powder scattering

Powder adhesive lamination is the most versatile, and probably the most economical method of hot-melt lamination, because powder can be applied at any optimized weight and width, and also because powder is not as costly as the corresponding web or film. Careful thought and pre-trials are needed to determine on which of the substrates to scatter the powder. The usual procedure when laminating automotive fabrics to foam is to scatter the powder on to the face fabric first because the unsupported foam on some machines is not capable of being self-supporting. When the scrim is laminated the powder must be put on to the foam because in most cases the scrim construction is too open to scatter powder on it. In this situation however, powder may sink into the foam and be wasted and therefore the choice of particle size needs careful consideration. Smaller particles are not only wasted, they can cause the foam to lose resiliency and reduce porosity. The machine consists of a hopper containing the powder with a gravure roller at the bottom, the effective length of which can be controlled by the use of blanking off plates. The roller rotates and picks up powder, which is scrapped off by a wire brush outside the hopper. The powder then falls onto the moving substrate below, see Fig. 4.16.

The amount of powder applied is controlled by the speed of rotation of the gravure roller and the speed of the moving substrate. The substrate, with powder on it, then passes under infra-red heaters which melt the adhesive. The speed must not be excessive or the powder adhesive will not be melted sufficiently. The second substrate to which it is being joined, is then placed over the molten adhesive and the two materials are then joined by bringing them together at a pair of nip rollers, or alternatively the substrates pass into a calender. When infra-red heaters and nip rollers are used, the same factors, relating to hot-melt adhesives, that were mentioned in connection with calenders, apply. The molten adhesive must have the correct viscosity at the temperature of bonding for satisfactory results. In addition the

correct balance of time (speed), temperature and pressure must be established for the actual substrates being joined and the powder adhesive being applied. As for calenders, too much pressure and time could cause the adhesive to strike through the substrates causing problems of appearance and stiffening.<sup>24,25</sup> Too low a temperature, too fast a speed and too low a pressure could result in a poor bond. Careful cooling may also be necessary to avoid curl in the completed laminate – commercial apparatus is available for this. Any powder which does not fall on to the substrate, can be collected in a tray underneath the machine and reintroduced into the hopper thus minimizing waste.

#### 4.4.8 Powder printing – dry and paste

Powder can be applied directly to the fabric by a dry printing technique using a gravure roller. This method is also termed ‘powder point’, see Fig. 4.16. Powder can also be compounded into a paste for dot printing through a rotary screen, e.g. Stork apparatus or for spreading with a doctor knife, i.e. by direct coating. With the paste process the fabric can if necessary, be rolled up after drying for reactivation at a later date by another unit or customer and this technique is widely used in the non-wovens industry. Preparation of the paste is a skilled compounding process because it is necessary to produce a paste with the correct viscosity, stability and flow properties as well as giving the adhesion required. The finest particle-size powder is normally used and in the case of screen printing, mesh size must be pre-decided to obtain a laminate with the required handle and bond strength.

#### 4.4.9 Melt print – roller and screen

In this process hot-melt powder or granules are melted into a trough. A gravure roller with indentations of the appropriate size for the materials being processed, picks up the adhesive in these indentations and transfers it by a print process on to one of the substrates. The material is then joined to the other substrate by nipping together. A variation of this method makes use of mesh screens, see Fig. 4.16. Indentation size and mesh size, are critical in producing a laminate with the required bond strength and handle and it is likely that more than one or two rollers or screens will be necessary to cover the range of adhesive add-on required for a range of different substrates. The same considerations of molten adhesive viscosity, time, temperature and pressure already discussed above apply, to produce a laminate with the correct qualities. One drawback to these processes, is the amount of down time necessary to clean the machinery, especially when the adhesive, roller or screen is being changed. Hot-melt moisture-cure

polyurethane adhesives are applicable by this technique, and apparatus to prevent premature cross-linking by making use of an inert gas such as nitrogen may be necessary.

#### 4.4.10 Slot die extruder

The machinery includes pumps capable of delivering liquid molten adhesives, jacketed or heated hoses and a coating head capable of delivering adhesive uniformly across the width of the goods. A drum unloader with a heated platen is required for adhesive in jelly form and a screw extruder for adhesive in powder or granule form. To produce a flexible laminate, the adhesive is extruded in a discontinuous array of dots or small streaks. Again the same balance of time, temperature and pressure apply to obtain just the correct bond strength without laminate stiffening or adhesive strike through and again the adhesive must have the correct viscosity. The molten adhesive is applied to one of the substrates just in front of a pair of nip rollers and just before the second material is introduced, see Figs. 4.21 and

Arrangement for adhesive powders or granules

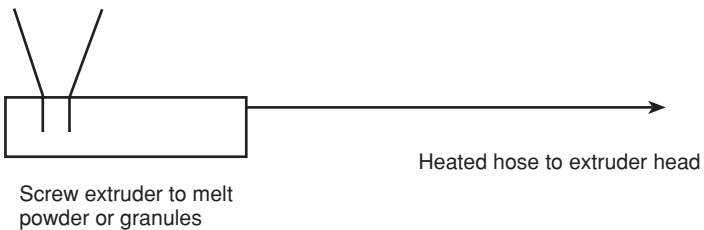

Arrangements for moisture-cure polyurethane adhesives

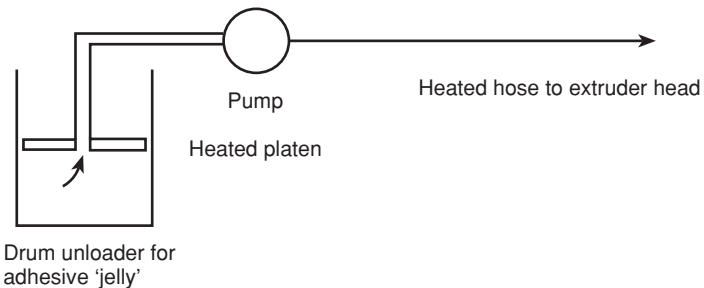

4.21 Slot Die Extruder Adhesive Applicator. Adhesive delivery methods.

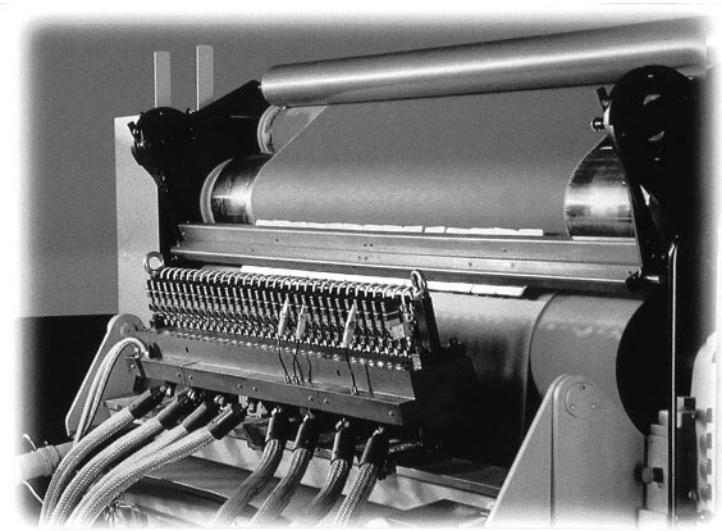

4.22 Slot Die Adhesive coating and lamination head. Courtesy of Nordson (UK) Ltd and reproduced with kind permission.

4.22. An important advantage of this method is that the substrates being joined are not themselves exposed to heat during the lamination process and so there is minimal risk of damage to fabric aesthetics of texture and pile.

Because the hot-melt adhesive is enclosed right up to the moment before use, this allows the use of moisture-curing polyurethane adhesives. These adhesives are activated by moisture from the atmosphere and in the substrates themselves. The chemical cross-linking allows high bond strengths at low levels of add on, and because they are also 100% active material with no solvents present, they are environmentally friendly. Machine downtime in this process is believed to be a minimum because the adhesive is mainly totally enclosed within the system and all parts are heated. A blanket of an inert gas such as nitrogen is sometimes necessary to prevent premature cross-linking of the adhesive during down periods.

#### 4.4.11 Spray application

The problems usually associated with spray applications are uniformity and precision of application, occasional blocking of a spray nozzle, control of the liquid being sprayed – usually a solvent and continuous drying of the liquid. In theory, all types of liquid adhesives can be sprayed, hot-melt, solvent-based, water-based and high-solids versions. In practice however, hot melts need expensive apparatus to ensure they do not solidify pre-

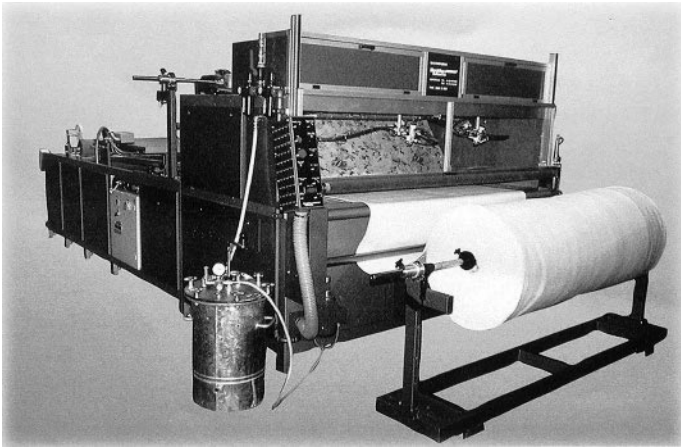

4.23 Machtex Multi-purpose spray adhesive laminating and coating machine, Type CMW-3. Reproduced with kind permission of Mach Tex Holland BV.

turally or char, solvents present problems of flammability and water-based adhesives may not dry at commercial speeds. In recent years, reactive polyurethane adhesives have been developed which allow high bond strengths with low levels of add-on. Moisture-cure polyurethane adhesives do not need a high temperature to initiate cross-linking and are available as a jelly with virtually 100% solids content.

Machtex of Holland have specialized in spray lamination machines over many years and their machines can be used to process materials such as raised velvets or velours which would be damaged by high temperatures and pressure. Figure 4.23 shows their CMW-3 Machine is a multi-purpose model suitable for several adhesive types.

#### 4.4.12 Discussion of the various methods

In common with all lamination methods, the substrates must be delivered to the lamination head, where they are actually joined together in a flat tension-free condition, if a quality dimensionally stable laminate is to be produced. This is not easy with polyurethane foam and lightweight knitted scrim fabric, both of which stretch easily, especially at the lamination speeds necessary for a commercially viable process. Lamination is a critical process and must be carried out with precise control for consistent stretch and set properties, consistent thickness, consistent bond strength and the ability to lie perfectly flat for accurate panel cutting. The machine feed and take up units are just as important as the lamination unit itself. They need careful design and set up if lamination is to continue at commercial speeds when

fresh rolls of face fabric, foam and scrim are joined on without stopping the process. These material-handling logistics are common to all methods of lamination. Fabric surface geometry, handling considerations, volumes being processed, plant and personnel skills available all contribute to the hot-melt application method. A schematic multi-purpose lamination range is shown in Fig. 4.20. In all hot-melt processes one of the main problems is rapid cooling and premature loss of stickiness, ('tack') of the hot-melt adhesive in air before the second material can be introduced. This is particularly relevant of powder adhesive containing small individual particles which lose heat to the surroundings very quickly. The time the adhesive remains molten and tacky is referred to as 'open time'. Sometimes small secondary heaters, an infra-red bar or even a small ceramic heated bar, are used to provide extra heat just before the joining nip to prolong the open time.

When the various methods are costed, *all* factors must be taken into consideration, i.e. cost of adhesives, energy consumption, speed of process, time spent on cleaning and maintenance, time spent when adjustments are made to produce different qualities of product, manning levels, 'burn off' of foam or reduction in thickness. Fume abatement – both initial installation and running costs, and cost of second quality material produced must also not be overlooked. Other ancillary items which may also be required should be noted and included, e.g. drum un-loader apparatus, hot-melt extruder and pumps in the case of hot-melt adhesives. For high production levels involving polyurethane foam, flame lamination appears to be still the most economical method for most producers despite the increasing cost of emissions control.

#### 4.4.13 Welding

Welding of textiles and plastics is essentially a hot-melt process and only thermoplastic materials can be welded directly. There are two types commonly used in textile and plastic processing, i.e. ultrasonic welding where localized heat is produced by vibrational mechanical energy and HF (high frequency) and RF (radio frequency welding).<sup>26,27</sup> In the latter two cases – which are similar processes – the localized heat is produced by molecules of the substrates vibrating rapidly in an applied electrostatic field. The thermoplastic materials must first melt and then flow and form a bond. Materials which weld well by one method do not necessarily weld well by the other methods. PVC is by far the best material for HF welding but produces only acceptable results with ultrasonic welding. Hot-melt adhesives can also be activated by welding techniques and used to join materials which cannot be satisfactorily joined together directly. To be suitable for RF welding the material must be thermoplastic with a high 'dielectric loss factor' and must have the correct melt flow properties.

## 4.5 References

1. Kramrisch B (Oldham S, Ciba), 'Dyeing of automotive fabrics', *International Dyer & Printer*, December 1986, 28.
2. Osman P (Ford), 'Dyestuff selection and colour control for the car industry', *International Dyer & Printer*, June 1985.
3. Kowalski M, 'Automotive textiles to date', *Textiles*, 1991, 2 10–12.
4. Fulmer TD, 'Dyeing textiles for automotive interiors', *ATI*, December 1993, 88–90.
5. Pearson DJ, (Guildford), 'The finishing of automotive textiles', *JSDC*, December 1993, 388–90.
6. Larkins T, 'Right-first-time, the role of automated dispensing in the dyehouse', *JSDC*, 110, January 1994, 10–12.
7. Browning S, 'Right-first-time, a new approach', *JSDC*, 110, January 1994, 8–9.
8. Yang Y & Allegood DC, 'Levelness of dyeing and unwinding performance of 100% polyester two-ply yarn packages', *Textile Chemist and Colourist*, 31 (3), 1999, 32–6.
9. Anon, 'Yarn Package Dyeing', *International Dyer*, May 1995, 21–36.
10. Aspland JR, 'Disperse dyes and their application to polyester', *Textile Chemist & Colorist*, December 1992, 24 (12), 18–25.
11. Protonentis LT (Clariant USA), 'Trimer – what is it and how to manage it', *Yarn Dyeing '98' AATCC Symposium*, 16–17 April 1998, Pawley's Island SC USA, AATCC, North Carolina, 1998.
12. Clariant; Alkali dyeing of polyester, TI leaflet ref. 0684.00.96.
13. Osawa I, (Meisei), 'Alkali Dyeing of Polyester' TI sheet – January 1993.
14. Alkali Dyeing, TI sheet, T1654E Kayacelon, Nippon Kayaku.
15. Kinloch AJ, '*Adhesion and Adhesives*', London, Chapman and Hall, 1987, 56–100.
16. Garner C, 'The low down on flame laminating', *Inside Automotives*, May/June 1995, 23–5.
17. Garner R, 'Flame or dry? the debate is on', *Automotive & Transportation Interiors*, May 1994, 52–4.
18. Miles DC (Dermil), 'Dry powder bonding adhesives in automotive trim laminates', *J Coated Fabrics*, April 1991, 20, 229–39.
19. Hopkins J (Nordson), 'A comparative analysis of laminating automotive textiles to foam', *J Coated Fabrics*, January 1995, 250–67.
20. Woodruff F (Web Processing), 'Environmentally friendly coating and laminating; new process and techniques', *J Coated Fabrics*, April 1992, 21, 240–59.
21. Halbmaier J (Bostik), 'Overview of hot melt adhesives application equipment for coating and laminating full-width fabric', *J Coated Fabrics*, April 1992, 21, 301–10.
22. McBride R & Sellers J, 'Flame lamination meets environmental challenge', *Automotive & Transportation Interiors*, April 1994, 60.
23. Lebovitz R, 'Lamination process meet the global manufacturing challenge', *Automotive & Transportation Interiors*, December 1997, 40–1.
24. Griltex EMS, Hot melt adhesives manual, 500/3.95/SuT.
25. Bandwise Reliant, Technical information brochure, Coolstream LSTF, May 1997.

26. Anon, 'How physical properties affect ultrasonic welding', *BPR*, June 1988, 41–5.
27. 'Dielectric Heating for Industrial Processes, Handbook', Paris, Union Internationale d'Electrothermie, 1992, 9–11 and 32–3.

## 4.6 Further reading

### 4.6.1 Dyeing and finishing

1. Burkinshaw SM, '*Chemical Principles of Synthetic Fibre Dyeing*', London, Blackie Academic, 1995.
2. Ingamells W, '*Colour for Textiles – a Users' Handbook*', Bradford, Society of Dyers and Colourists, 1993.
3. Gohl EPG & Vilensky LD, '*Textile Science, an Explanation of Fibre Properties*', 2nd edn, Melbourne, Australia, Longman Cheshire, 1983.
4. Lewin M & Sells SB, '*Chemical Processing of Fibres and Fabrics; Functional Finishes Part B*', New York, Marcel Dekker, 1984.
5. Nunn DM (ed.), '*Dyeing of Synthetic Polymer and Acetate Fibres*', Bradford, Society of Dyers and Colourists, 1979.
6. Park J, '*A Practical Approach to Yarn Dyeing*', Bradford, Society of Dyers and Colourists, 1981.
7. Clarke G, '*A Practical Introduction to Fibre and Tow Colouration*', Bradford, Society of Dyers and Colourists, 1982.
8. Tortora PG & Collier BJ, '*Understanding Textiles*', New York, Prentice-Hall, 1997.

### 4.6.2 Printing

1. Boehme P, Haerri HP, Johnson P & McGarrie J (Ciba), '*Innovations in Automotive Textile Coloration, Meeting Customer Needs*', *IMMFC*, Dornbirn, 17–19 September 1997.
2. Boehme P, Haerri HP, Johnson P & McGarrie J (Ciba), 'Rapid and flexible technology for the automotive sector', *International Dyer*, February 1998, 21–4.
3. Clark W, '*An Introduction to Textile Printing*', London, Butterworth, 1974.
4. Dawson TL (UMIST), 'Ink-jet printing of textiles – under the microscope', *JSDC*, 116 (2), February 2000, 52–9.
5. FESPA '*European Screen Printer and Digital Imager*', Reigate UK, FESPA Association, 1999.
6. Gerard F, '*Textile Finishing; A Complete Guide*', Suasheim France, Editions Hightex, 1996.
7. Goldberg E, 'American car fabrics follow footsteps imprinted by Europe and Asia', *Automotive & Transportation Interiors*, July 1998, 45–6.
8. Richard CJ (Guildford), 'Pretty in Prints', *Inside Automotives International*, January 1998, 34–5.
9. Smith TL, 'Printed fabrics make their mark on US interiors', *Automotive & Transportation Interiors*, October 1994, 34–5.
10. Story J, '*Textile Printing*', London, Thames & Hudson, 1992.
11. Story J, '*Manual of Textile Printing*', 2nd edn, London, Thames & Hudson, 1992.

12. Tortora PG & Collier BJ, '*Understanding Textiles*', New Jersey USA, Prentice-Hall, 1997.

#### 4.6.3 Coating and lamination

1. AATCC Coated and Laminated Fabrics Symposium, Danvers, MA 3–4 April 1995, North Carolina, USA, AATCC.
2. Holker JR, '*Bonded Fabrics*', Merrow Monograph MM/TT/14, Watford, Merrow, 1975.
3. Kinloch AJ, '*Adhesion and Adhesives*', London, Chapman and Hall, 1987.
4. Kowalski M (Guildford), '*Automotive Textile Presentation*', *Autotech Seminar 9*, NEC Birmingham 1991.
5. '*Progress in Textile Coating and Lamination*', BTTG Conference, Chester, 2–3 July, Chester, Manchester, BTTG.
6. Shields J, '*Adhesives Handbook*', London, Butterworths, 1984.
7. Skeist I (ed.), '*Handbook of Adhesives*', 2nd edn, New York, Van Nostrand, 1977.
8. '*Textile Coating and Laminating*', Annual Conferences from 1990 onwards, Lancaster PA USA and Basel, Switzerland. Technomic Publishing.
9. Wypych J, '*Polymer Modified Textile Materials*', New York, John Wiley, 1988.

## 5.1 Quality assurance

Quality Assurance (QA), is a broader term than quality control in that it embraces all factors which have a relevance to quality and customer satisfaction. QA begins with involvement at the earliest stages of design, communication with customers, through product development, purchasing and monitoring of raw materials, the manufacturing processes, testing and inspection of the finished product and right through to liaising with the customer after delivery to ensure satisfaction. Every member of the workforce and staff is trained to regard quality as their duty, not just the actual quality department. This approach to quality management was set down in BS 5750 and CEN 2900 and later further developed into ISO 9000. These QA systems require detailed and comprehensive specification and documentation of the product being made, materials used, all manufacturing processes and the machinery used, operative training, test methods including standards required and tolerances together with clear records of results and regular review and auditing of all procedures. Only products with test figures within tolerances specified can proceed directly to the next stage of manufacture. Those with results falling below the standard are only sent after agreement with the customer. The objective of this monitoring system is to get things right first time by allowing corrective action to be taken before unsatisfactory products are made – prevention before, rather than detection and correction after. Waste is minimized and efficiency maximized. In mid-1994 a series of QA systems known as QS 9000 was specifically drawn up for the automotive industry by the ‘big three’ American OEMs, General Motors, Ford and Chrysler, with the support of the American truck (HGV) manufacturers and others. The Third Edition of QS 9000 issued in March 1998 included input from the European OEMs and a growing number of OEMs world-wide now require their suppliers to be accredited with this system or an equivalent which can only be awarded by licensed inspectors. In a similar way to ISO 9000, when a company is QS

9000 registered, it is subject to periodic random checks to ensure that it continues to comply with the system requirements.

### 5.1.1 Product testing

Production must be monitored for two main reasons, firstly to determine suitability for further processing so that the next process will be right first time every time and secondly, to simulate actual conditions of wear during the life of the automobile. Simulating actual conditions of use over a period of years with accelerated laboratory tests, is not easy nor straightforward, and each OEM has its own methods of doing this. In addition climatic conditions around the world, vary very significantly, and test methods must take all this into consideration. Test methods applied will also depend on the physical conditions of the next process, which the article being tested will have to withstand, and also where in the car it will be situated. Car seat covers have the highest abrasion requirements, whereas parcel shelves and dashboards have the highest lightfastness and UV degradation resistance requirements.

The shade of dyed fabrics must be carefully examined because two pieces of fabric used together in the same car may have been dyed in different dye lots or even different dye works, and the shades may appear slightly different. In addition if the fabric is used in conjunction with a coloured plastic foil or dyed leather the colours may again not be exactly the same. Care must be taken to avoid the occurrence of metamerism.

Fabric volumes are high, schedules tight and it is neither physically nor economically possible to test every single roll or piece of material. The frequency of testing depends on the nature of the process and is decided after consultation with the customer. Results are generally plotted on a statistical process control chart with maximum and minimum control limits. Thus the past history of a process, and any trends in results can be seen at a glance. Customers are informed of the results, especially if they are not precisely within the specification, so allowance can be made in the next process if necessary.

It is important that any poor quality or defects are seen and identified as soon as possible in the production sequence, because value is being added all the time. Some properties such as weight and thickness can be monitored automatically by microprocessors. However the final fabric examination, generally carried out manually is a slow and hence relatively costly process but customers now call for 'zero' defects in goods received, i.e. the exact standard agreed in the sales contract. Present zero defects allows for one marked fault in typically 10m of fabric. Existing automatic examination systems are not sophisticated enough to cope with the whole multitude of factors which result in second-quality material. The

technology is probably available, in theory at least, but the cost is prohibitive.

### 5.1.2 Test standards

Test standards are gradually being raised as the customer demands better value for money and competition amongst OEMs becomes even more intense. Cars being produced now are expected to last longer than before and to maintain high resale values of used cars, the interior must be in as good a condition as possible after years of use.<sup>1</sup> Abrasion resistance and light and UV degradation resistance are especially critical. Anti-soiling properties and effective cleanability are also becoming more important. There are many published articles on standards required and tests methods used.<sup>2-10</sup> In addition a number of textbooks on test methods are available, some of which are listed in Further Reading; the books by Merkel, and Saville are especially useful.

Manufacturing methods are changing and new tests are being introduced to allow rapid and consistent operation of the new techniques. Because of this, the seat makers themselves, the Tier-1 suppliers, are beginning to set their own test methods and standards. Examples of this can be found not only in seat making but also in connection with the new moulding techniques now being developed for door casings, car pillars and rear parcel shelves.

New specialist vehicles such as 'sports utility vehicles (SUV)', 'recreational vehicles' (RV), 'multi-purpose vehicles' (MPV), and in the USA pick-up trucks and mobile homes, are creating new requirements associated with the intended use of the vehicle – or the image it creates. An example is the pick-up truck, the 'cowboys' Cadillac' which conjures up a robust utility vehicle, (Ford advertises their product as 'built Ford Tough'), and it is likely to be treated as such! In the USA car leasing has become more widespread and so the 'private life' of the car does not start until it is say 2 years old. It must not only be in almost showroom condition after this time but it is also going to have a longer life. The American OEMs are expected to push up the specifications of light and UV degradation resistance and also that of abrasion. In addition the move towards 3-year warranties on new cars by European and American OEMs (to match the Japanese and Koreans) is also likely to lift standards all round.

### 5.1.3 The diversity of test methods

Test methods and standards required by individual OEMs or Tier-1s are generally confidential between themselves and their suppliers. They are however, usually based on national, international or institutional standards

e.g. BS, DIN, ASTM or SAE. Table 5.1 summarizes the main test methods in use for interior trim. However, performance standards as well as test methods can vary quite significantly and what is acceptable for one OEM may not be acceptable to another. Some attempts have been made to harmonize test methods both in the USA and Europe, which can only be good for the industry as a whole.<sup>11,12</sup> Test laboratories must be equipped with two, three or even more different types of apparatus to measure the same property, for example for abrasion there are the Martindale, Schopper and Taber apparatuses. All the time, effort and expense incurred by the multitude of different methods could be directed towards more constructive purpose to take the whole industry forward faster. There is some pressure from the United Nations, governments and professional bodies, including the International Organisation of Motor Vehicle Manufactures (OICA), to harmonize test methods and standards in general, not just in the textile and automotive industries.<sup>13</sup>

#### 5.1.4 Processability quality checks

The main properties required for downstream processing include: consistent dimensions of width and thickness; porosity; stretch and set; dimensional stability; elongation; ability to lie flat (curl); cold water stability; peel bond (lamination adhesion); and heat/humidity ageing.

Panel cutting, usually on a cutting table precedes all making up procedures. Many layers of fabric are cut at the same time and the laminate must lie flat for accurate cutting. There must not be any inherent instability to cause the laminate to distort or alter its shape in any way. If the seat cover laminate has been laminated with any one of the components under tension, it may alter slightly in dimension when unrolled or cut. Large cut panels may stretch under their own weight, especially knitted fabric laminates. This is inevitable, but they must all stretch by a consistent amount within close limitations. Mass production methods and getting the process right first time, every time, requires starting materials with consistent properties. Pour in foam methods require consistent porosity, so foam does not strike through to the fabric face and in addition laminate thickness must be within certain limits for some moulding techniques.

Consistency of properties is vital if production is to proceed without continual stops to adjust settings on machines or equipment. With just-in-time production techniques now in widespread use, everybody's production schedules are linked closely together, and a hold-up in one area is likely to cause a hold-up everywhere downstream. The ultimate hold-up is the OEM assembly line where all parts come together at just the right moment. Certain OEMs impose substantial financial penalties if their production line ('the track') is delayed.

Table 5.1 Summary of test methods applied to automotive seating and interior trim fabrics

	British Standard Test Methods	Selected Related Test Methods
Fabric weight measurement	BS2471	SAE J860 DIN 53353
Fabric thickness measurement	BS2544	SAE J882 DIN 53352
Visual evaluation of interior/exterior trim	—	SAE J361
Colour fastness	BS1006: 1990 (1996) Methods of determining colour fastness to about 70 different agencies BS1006: Grey Scales for assessing changes in colour AO2 BS1006: Grey Scales for assessing staining AO3 BS1006: BO1 Blue wool standards	ATCC Test Method 16 ASTM methods  DIN 54022 (fastness to hot pressing) DIN 54020 (rub fastness)
Crocking (wet and dry)	BS1006: 1990 (1996)	SAE J861 Jan 94 AATCC Method 8 DIN 54021
Lightfastness	BS1006: 1990 (1996)	SAE J1885 Mar 92 water-cooled xenon-arc SAE J2212 Nov 93 air-cooled xenon-arc SAE J2229 Feb 93 outdoor under glass variable angle SAE J2230 Feb 93 outdoor under glass sun tracking DIN 75202 FAKRA 7/91

Abrasion	BS5690: 1991 (Martindale) NB: sometimes tested after UV exposure	SAE J365 Aug 1994 Scuff Resistance (Taber) SAE J2509D ASTM D3884-92 (Taber rotating platform) ASTM D3885 Flexing Abrasion (Stoll) ASTM D3886 (Inflated diaphragm) DIN 53 863 3/4 Martindale) DIN 53 863/2 (Schopper) DIN 53 528 (Frank Hauser, loss in mass for coated fabrics) DIN 53 754 (Taber)
Pilling	BS5811: 1996 pill box	ASTM D3511-82 (Brush) ASTM D3512-82 (Tumble) ASTM D3514-81 (Elastomeric pad) DIN 53863/3 (modified Martindale) DIN 53865 (modified Martindale)
Frosting		AATCC Method 119 (screen wire) AATCC Method 120 (emery)
Snagging		SAE J948 Aug 94 (also abrasion of vinyl/leather) ASTM D5362-93 (bean bag) ASTM D3939-93 (mace test)
Tear strength	BS4303: 1968 (1995) wing tear BS3242 pt5: 1982 (for coated fabrics) BS4443 pt6 Method 15 (for foam laminates)	ASTM D2261: 96 (tongue tear – single rip CRE) ASTM D1117/95 (trapezoidal tear) DIN 1424-96 Elmdorf tear apparatus DIN 53 356 (tear propagation)
Tensile strength/ breaking and elongation	BS1932 for yarns and threads BS3424: 1982 Method 6 (coated fabrics) BS2576: 1986 (woven fabric/strip method) BS4443 pt6 Method 15 cellular foam (laminates)	ASTM D-751 (Test for coated fabrics) ASTM D1578-93 yarns by Skein method ASTM D1682 (Grab method) not for knitted fabrics ASTM D2261-96 for woven fabrics – single rip (CRE) ASTM D5034-95 (Grab method) DIN 53857 (non wovens) DIN 53571 (tensile and elongation)
Stretch and set	BS3424 pt21: 1987 (for coated fabrics) but BS3424 pt24 1973 still in use	SAE J855 Jan 94 DIN 53853 DIN 53857

Table 5.1 (cont.)

	British Standard Test Methods	Selected Related Test Methods
Stretch and recovery	BS4952: 1992 (for elastic fabrics – replaces BS4294: 1968)	ASTM D3107-75 (lower stretch wovens) ASTM D1775-94 (elasticated fabrics – CRL) ASTM D2594-87 (low power knits)
Bursting strength	BS4768: 1972 (1997) Bursting strength and destinsion	DIN 53861 ASTM D3786-87 (Mullen or hydraulic test for knits/non-wovens) ASTM D3787-89 ball method for knits – CRT
Dimensional stability	BS4736: 1996 (cold water)	SAE J883 Jan 94 Cold Water SAE J315A DIN 53894
Stiffness	BS3356: 1990 bending length and flexural rigidity	ASTM D1338-96
Drape	BS5058 1973 (1997)	DIN 53350 (bendability)
Crease recovery	BS EN 22313: 1992	AATCC Method 88C
Seam strength yarn slippage	BS3320: 1988 woven fabrics seam method BS2543 woven and knitted upholstery	ASTM D4034-92 woven ASTM D1683-90a for woven fabrics SAE J1531D ASTM D4159 (simulated seam)
Peel bond	BS3424 pt7 1982 Method 9 (coating adhesion)	ASTM D751 ASTM D902 DIN 53357
Compression (for foam/laminates)	BS4443 pt1 Method 5A stress strain characteristics BS4443 pt1 Method 6A compression set	ASTM D2406-73 Method B DIN 53 572 Compression set DIN 53 577 Stress strain characteristics
Odours		SAE J351 hot odour test (for insulation materials)

Air permeability	BS5636: 1978 for fabrics now BS EN ISO 9237: 1995 BS4442 pt6 1980 Method 16 (for foam laminates) BS6538 pt3 1987 (Gurley Method)	ASTM D737  DIN 53887
Surface resistivity (antistatic)	BS6524: 1984 (surface resistivity)	DIN 54345 DIN 53282 (surface resistivity) ASTM F365-73 Charge Decay Federal Method 101C – 4046 (Charge Decay) BTTG Body Voltage Chair Test
Cleanability		AATCC Method 118 – 1992 (oil repellency) 3M Methods
Stain repellency	BS4948: 1994 soiling by body contact	
Fogging	BS AU 168: 1978	SAE J1756: 1994 ASTM D5393 DIN 75201
Flammability resistance	BS AU 170 1979: 1987	FMVSS302 DIN 75200 SAE J369
Water wicking		SAE J913
Acoustic/thermal		SAE J1324 Oct 89 Recommended Practices
Accelerated ageing methods	BS3424: 1996 pt 12 for coated fabrics BS4443 pt 4 Method 11 for cellular materials (foam) humidity and elevated temperatures BS4443 pt6 Method 12 (heat ageing)	ASTM D2406-73 DIN 53378 'Environmental cycles' of individual manufacturers as pretreatments for further testing, e.g., peel bond dimensional stability, effect on appearance and shade change. Sometimes includes cooling to as low as -40°C and heating to as high as 120°C
Resistance to micro-organisms		AATCC Method 30 resistance to mildew and rot AATCC Method 100 resistance to bacteria AATCC Method 174 bacteria resistance for carpets Federal Test Method standard 191 Method 5750 Mildew Resistance, Mixed Culture method

### 5.1.5 Customer satisfaction quality checks

The more familiar tests associated with fabric include the following: uniformity of shade; regularity of pattern; abrasion resistance; lightfastness; wet perspiration dye fastness; dye-crocking fastness; tear strength; bursting strength; laminate peel bond; crease recovery; cleanability/soil resistance; 'environmental' tests; and flame resistance.

Test specifications may seem unrealistically high to the layman, but it is easy to misjudge the wear and tear over several years of daily use and the combined effects of high temperature, varying humidity and UV radiation. Cars produced in say the UK must generally be capable of withstanding climatic conditions in any part of the world. In recent years the following factors have grown in importance or become more critical: fogging; odour-free; cleanability; and antistatic properties.

## 5.2 Test method details

This section provides some details and comments on the more common tests applied to automotive fabrics. The test laboratory should be controlled to the standard textile laboratory conditioned atmosphere of 20–22°C (68–72°F) and 60–70% relative humidity. Test apparatus should be calibrated at least annually and a certificate issued by the certifying body.

### 5.2.1 General checks and appearance

General items such as the correct fabric width, weight, thickness, and construction (ends/picks in woven fabrics; courses/wales in knits), must be checked regularly to ensure that they are as specified by the customer. There are standard procedures for these relatively simple tasks. They can in fact, sometimes give clues to other properties, for example, thicker than normal laminates could indicate less burn off or lower pressure during lamination and perhaps lower peel bonds. Fabrics with raised surfaces need to be examined for pile in the correct direction, pile distortion and correct pile height. The fabric design must be examined for regularity, especially warp and weft lines ('bow and skew') to ensure that they are within agreed tolerances.

### 5.2.2 Colour shade approval

Dyebatch to dyebatch shade variation is inevitable and virtually impossible to eliminate completely even within the same dyehouse, let alone different dyehouses, possibly in different countries. It is therefore important that the customer and his dyer must agree on what is acceptable and what

is not. Nowadays this is usually assessed objectively on a 'pass or reject' basis using quantitative colour information obtained with colour measurement instruments. This procedure removes human error and subjective assessment variations, which used to present so many problems in the past.

As stated in Chapter 4, two types of instrument are in use, the spectrophotometer and the tristimulus colorimeter both producing data from which quantities known as the chromaticity co-ordinates can be calculated. This information is measured from an agreed standard master shade and also from the submitted test pattern. A colour computer then processes the data from both sets of measurements and calculates the differences between them. These differences can be mathematically processed and represented by a single figure. The size of this figure relates to the magnitude of the colour difference between the submitted pattern and the standard master shade. If the submitted shade is acceptable it should be inside an agreed tolerance. There is, however, more than one method of processing this information for pass/fail decisions.

A widely used system involved the so called, CIE 1976  $L^* a^* b^*$  co-ordinates which were recommended by the International Commission on Illumination, (Commission Internationale de l'Eclairage) to specify a particular shade of colour. The co-ordinates comprise three numerical values to specify the colour in three-dimensional colour space on the axes;  $L^*$  representing lightness (i.e. 0 = black, 100 = white),  $a^*$  where positive values are red and negative values are green,  $b^*$  where positive values are yellow and negative values are blue. The computer then calculates the difference between the two test patterns for each of these co-ordinates. The differences are represented by delta  $L^*$ , delta  $a^*$  and delta  $b^*$ . The difference between the two patterns in colour space gives the total colour difference represented by delta  $E$  (calculated using Pythagoras' Theorem for triangles).

This equation, CIELAB 1976 did not always give consistent results with textiles across a broad range of different shades. Further work was then carried out to improve this situation by various researchers including colour instrument makers and major purchasers.<sup>14</sup> Eventually, development work under the auspices of the Society of Dyers and Colourists resulted in the publication of the CMC(2:1) equation which has proved to be a significant improvement on CIELAB 1976 for acceptability decisions. This equation has now been adopted by both ISO and CEN and is published as the International Standard for Colour-difference Measurement as BS EN ISO 105-J03:1997.

It is possible to calculate a value for delta  $E$ , which represents the actual difference perceptible by the human eye. However this quality is complicated by the fact that the human eye is more sensitive to certain colours and all the other human limitations, including fatigue. The situation is not

completely resolved – not all dyehouses use CMC(2:1) for their pass/fail systems. However, the ultimate decisions are made on *visual* assessment under specified lighting conditions and dialogue between the dyer and the customer.

### 5.2.3 Colour fastness and crocking

The car seat cover is fixed to the seat and washing fastness is not an issue, however perspiration dye fastness, cold-water leaching and rubbing fastness (tested by crocking) must be checked. Simulated human perspiration liquor is made up, and a test sample of the fabric is wetted out with it and sandwiched between two white undyed pieces of fabric, one is cotton, the other sometimes wool or made from several different fibres (so called multifibre test material). The 'sandwich' is placed between glass plates and put into an oven for 4h at 37°C to simulate body heat. Any staining off of loose dye is assessed using Grey Scales, of which there are two types. One type is used to assess change of shade (COS) of the dyed fabric, the other type is used to assess the mark off or bleed off of loose dye on to the white undyed pieces of fabric used in the test. Grey scales standards were prepared in accordance with the International Standards Organisation and are specified in BS 1006, (ISO 105-A02). Rating 5 indicates no change of shade with the COS grey scale and no staining off with the staining grey scale. Rating 4 indicates slight and generally acceptable levels of change of shade and staining off.

Rub fastness, both wet and dry is assessed using a Crockmeter, a machine with a wooden peg around which is fastened a white piece of cotton fabric. The machine action is to rub the fabric sample ten times with the cotton fabric covered peg, after which any staining off of dye is assessed using Grey Scales. It is especially important to check dyed polyester by these fastness tests to ensure that the reduction clearing treatment after dyeing has been effectively carried out.

### 5.2.4 Lightfastness and UV degradation resistance

This is probably the single most important test and also the most difficult to reproduce and consequently much research has been carried out.<sup>14-21</sup> One of the reasons of course is simply because sunlight conditions vary not only according to location in the world, especially latitude, but they also vary at a given place according to the position of the sun in the sky and therefore the time of day. The weather and cloud cover are also relevant factors in addition to variations in actual solar UV radiation. The large amounts of glass in modern cars allow the entry of substantial amounts of sunlight, which heat up the confined space of the car raising the tempera-

ture to as high as 130°C in extreme conditions in the Arizona Desert. On normal summer days in the UK, temperatures of car interior surfaces exceed 70°C with ambient exterior temperatures of only 23°C. As the sun sets, the temperature will fall and this will significantly affect the relative humidity and cause dampness. Some test procedures attempt to reproduce all of these conditions. The daily cycle of heating and cooling could be influencing rate of colour fade and fabric degradation. Some tests such as the American standard SAE J1885 includes a period with the light switched off to simulate this. If the procedure involves the sample becoming wet, the test is best described as a weathering test rather than a light-fading test.

Sunlight is a mixture of all the colours of the rainbow plus infra-red, ultra violet and other radiation, see Fig. 5.1. The UV rays are the shortest in wavelength and, having the most energy, are by far the most damaging to fabrics. Although much of this radiation is filtered out by car window glass some of the longer UV rays still penetrate. The thickness of the car window glass will have an effect – the thicker the glass, the fewer UV rays enter the car.

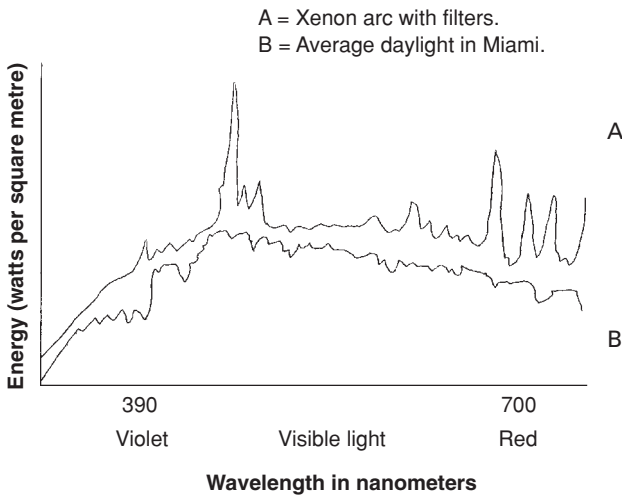

- 5.1 Spectral Energy Distribution of Daylight compared to that obtained with artificial Xenon arc light with filters. Diagram produced from information supplied by Atlas Material Testing Technology BV. A Nanometer (nm) is one millionth of a millimetre. Visible light, made up by the colours, violet, blue, green, yellow, orange and red is in the region of 390 nm to 700 nm, with violet (390 to 430 nm) and red (610 to 700 nm) at each end. Beyond the range of visible light is ultraviolet (30 to 390 nm) and infrared (700 to 3000 nm). The shortest wavelengths have the most energy and the ultraviolet is the most damaging radiation to textiles, but windscreen glass filters out some parts of it.

Tinted glass also reduces the amount of radiation including visible light but there are safety limitations on the degree of tint permissible.

Following investigations over a number of decades, researchers agree that, among other factors and combination of factors, the three most important single factors causing degradation by sunlight are, UV radiation, heat and dampness. To obtain test results, which will give accurate information on likely performance over several years in actual use in the car, the test machines use these three factors at extreme, but realistic levels, mainly running all altogether at the same time. It is important that these extreme conditions are comparable to what is observed in actual daylight because misleading information could result. For example using substantially higher levels of radiation could cause other types of degradation, which would never actually occur under natural conditions. However, it is important that the test is completed in the shortest possible time so that fabric can be released for use as soon as possible after manufacture.

Clear information on the type of test machine and the light source is vital because the spectral distribution of the light source and the filters used vary from machine to machine. In addition both lamp and filters have a finite life and deteriorate during use, making it necessary to monitor their performance and to replace them regularly. In some machines the gradual deterioration in lamp efficiency is compensated by an automatic increase in wattage.

Development of a suitable artificial source of light, which accurately reproduces natural sunlight, was one of the first tasks faced by research workers. The first lamp developed was the enclosed carbon arc (Atlas in 1920s) which was used in the Fade-Ometer. The spectral distribution of this lamp was very different to sunlight because in particular, UV rays, which are responsible for much of the damage caused by sunlight, were absent. This situation improved shortly after with the appearance of the sunshine carbon arc, which was used in the Weather-Ometer. This lamp had a better resemblance to sunlight and did produce accelerated fading, allowing some useful results. However it contained certain bands of UV radiation which do not occur in natural sunlight, and therefore it was judged to be too severe. Furthermore some visible light was absent from its spectrum. Maintenance was expensive because the electrodes of the carbon arc lamps had to be changed daily and test machines using fluorescent lamps appeared as cheaper alternatives. Although fluorescent lamps do give accelerated fading and may be of some use, they are now considered unrealistic because, although their spectrum is rich in UV radiation, other wavelengths are absent.<sup>15</sup>

The latest developments involve the xenon arc lamp, which is at present the best reproduction of natural sunlight commercially available, see Fig. 5.2. The first machine of this type, which was introduced during the 1950s

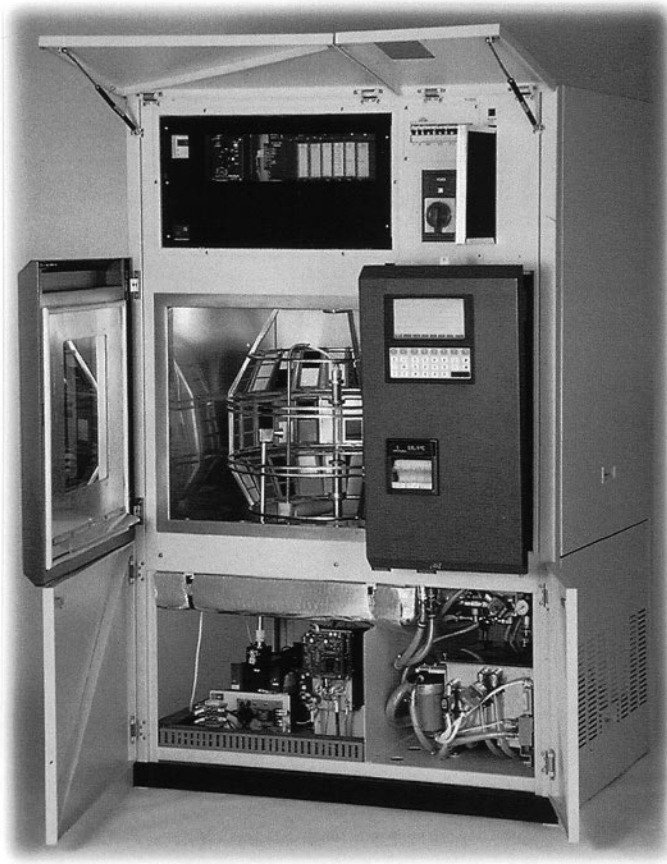

5.2 Ci4000 Weather-Ometer (Atlas Material Testing). The test samples and lamp are located in the centre of the illustration. The apparatus accurately controls the uniformity of light, temperature and humidity of the test samples. Photograph supplied by Atlas Material Testing Technology BV and reproduced with kind permission.

by Heraeus, was an air-cooled model. A water-cooled model produced by Atlas followed shortly after, and both types now are in widespread use. However, it is important to specify the method of cooling and which filters are to be used, because the spectral distributions of the two types are not the same. Results of fading tests will be different because of the following reasons. The Atlas model has two glass tubes around the xenon lamp, which act both as filters and also as part of the cooling apparatus. The spectral distribution of the light is therefore the same in all directions. The air-cooled Heraeus model on the other hand uses a combination of filters to produce an overall spectral distribution. The carbon arc lamp is still used but this is

declining in favour of the xenon models. There is now some evidence available, supporting the view that the whole spectrum of sunlight needs to be reproduced to obtain accelerated test results, which accurately reproduces damage by natural sunlight.

For the above reasons the OEMs specify the test method they require, including the type of machine, and a typical test requirement includes the following information: test machine model and lamp; filter system; humidity; test chamber temperature, (ambient inside the apparatus); black panel temperature, (temperature of the actual test sample); exposure time.

The test standard can be specified by the amount of fading or discoloration acceptable, as assessed by Grey Scales or the wool Blue Scale after exposure for a certain length of time under the specified conditions. The Grey Scales are prepared according to The International Standards Organisation and BS 1006 in the UK. The wool Blue Scales were developed by the Society of Dyers and Colourists in conjunction with other relevant organizations, and are based on eight dyes, one for each level of lightfastness rating. Note that the Blue Scale used in the USA is not the same – it is based on mixtures of two dyes to give the eight levels. With both wool Blue Scales, each level requires approximately double the amount of energy as the level immediately beneath it to produce the same level of fading. Alternatively the fading or discoloration is assessed after exposure to a measured amount of energy in kilojoules per square metre ( $\text{kJ/m}^2$ ). The American wool Blue Scale 7 is approximately equivalent to  $680 \text{ kJ/m}^2$  at 420 nm wavelength of light.

In addition to all the factors discussed above, obtaining reproducible and inter-laboratory test results, which agree with each other may prove difficult for a number of reasons. The test substrate itself may not be completely uniform and may have varying amounts of chemical finishes, UV absorbers or other substances on it. In addition fabric samples could have been produced under varying processing conditions of scouring, stentering or lamination etc. One factor, which is especially difficult to reproduce in the laboratory, is the effect of several years' exposure to air pollution and traffic fumes, the composition of which will vary widely with location. These factors may also be playing a part in conjunction with the combined effect of all the other variables, not to mention the surface abrasion and other factors associated with the car occupants sitting on the fabric.

Fibre lustre, or the titanium dioxide delustrant added to the yarn during manufacture, has a very significant effect on UV resistance as can be seen from Table 1.3. Matt yarns, which contain the most delustrant, break down significantly faster than bright yarns. This is thought to be due to the titanium dioxide photosensitizing degradation, or because of light being scattered more internally within the fibre filament in the case of delustrated yarns. UV degradation is also influenced by the thickness of the filament; the

thicker, the better. This is because less radiation will penetrate into the centre of the filament and the lower specific surface area of the thicker filament reduces the rate of photo-oxidative attack.

When fabric is tested for lightfastness and UV degradation, it is important to test it either in the laminated form or with polyurethane foam underneath it. The foam is believed to act as a heat sink and hence more accurately reproduces the conditions actually prevailing inside the car.

Different OEMs specify different test conditions but there are steps to standardize procedures to reduce the number of test methods especially in the USA and Europe. In Germany there has been some successful harmonization with the FAKKRA test procedure, DIN 75202 being widely used, and, in the USA, the SAE J 1885 test is widely used. Harmonization should result in some savings because fabric producers supplying several OEMs must possess every machine necessary and these machines are expensive to buy and expensive to run.

### 5.2.5 Abrasion resistance and associated factors

Fabric is normally tested for abrasion in the form in which it will be used in the car, i.e. when laminated to polyurethane foam and back coated if specified. Abrasion results are usually slightly better when the fabric has been laminated to polyurethane foam, compared to abrasion results carried out on the base fabric alone. This is because the foam helps to lock the fibres together in the fabric. When it is necessary to test non-laminated (singles) fabric, for example during fabric development, a small piece of polyurethane foam is placed underneath the fabric being tested in the test holder. Sometimes the foam is attached to the fabric sample with double-sided adhesive tape to simulate lamination. Some test procedures require exposure to light and UV radiation before testing, which significantly reduces the abrasion performance in most cases. Where in the car the fabric is situated determines the standard of abrasion required. The seat usually requires the highest standard of abrasion; some OEMs specify different standards for the centre seat panels, the bolster (the side and front edges of the seat), and the back of the seat – the bolster requirements usually being the most demanding. Door casing fabric specifications are sometimes lower than those for the seat and those of the headliner are significantly lower.

There are three main test methods for abrasion resistance in use, Martindale (using 12 kPa, 28 oz weight), Schopper and Taber which *very generally* agree with each other – but certainly not always, see Figs. 5.3–5.5. The three test methods actually represent different types of abrading motion as well as using different abrading materials. The Schopper machine operates with a reversing circular motion, whereas the Taber motion is a little more



5.3 Martindale Fabric Abrasion Tester. Photograph supplied by SDL International Ltd and reproduced with kind permission.



5.4 Karl Schroder Schopper Abrasion Testing Machine. Photograph supplied by SDL International and reproduced with kind permission.

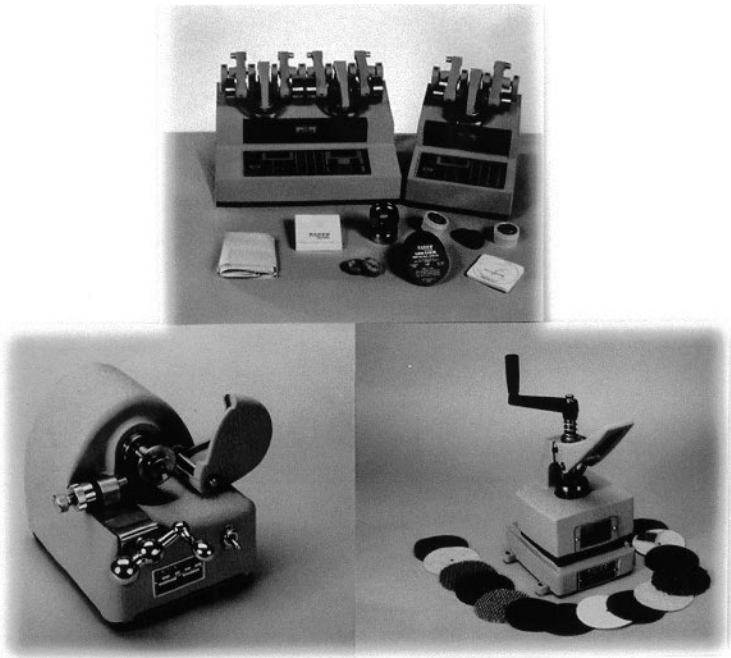

5.5 Taber Industries Abrasion Testing Machine. Photograph supplied by SDL International and reproduced with kind permission.

complicated with two circular wheels rotating in opposite directions. Martindale operates in a multi-directional manner, the abrading heads moving in a Lissajous pattern. The Taber uses an abrading wheel made from rubber/aluminium oxide abrasive particles (Calibrase), the Schopper uses fine emery paper, whereas the Martindale uses a standard grade of woven wool. Many researchers regard the Martindale's multi-direction action and use of wool as the abrading material as the most realistic of the three tests, but it does take substantially more time than the other two. To reproduce significant wear in actual use, a minimum of 50000 Martindale rubs are necessary taking about 16h to complete. In comparison a comparable Taber test only takes 15–30min and a typical Schopper test requires 1–2h. Abraded samples appear in Fig. 5.6.

Abrasion is influenced by the fabric construction, yarns used, finishes applied and amount of coating. Yarns of higher dtex/filament generally have better abrasion than yarns made from finer filaments. Highly textured yarns usually have slightly lower abrasion than yarns with a lower degree of texture. Excessive wet processing, prolonged dyeing or rigorous reduction clearing can all reduce abrasion resistance, and in some cases spun-dyed yarns may have better abrasion resistance than yarns of the same shade, which have been aqueous dyed. Fabric construction can have a substantial

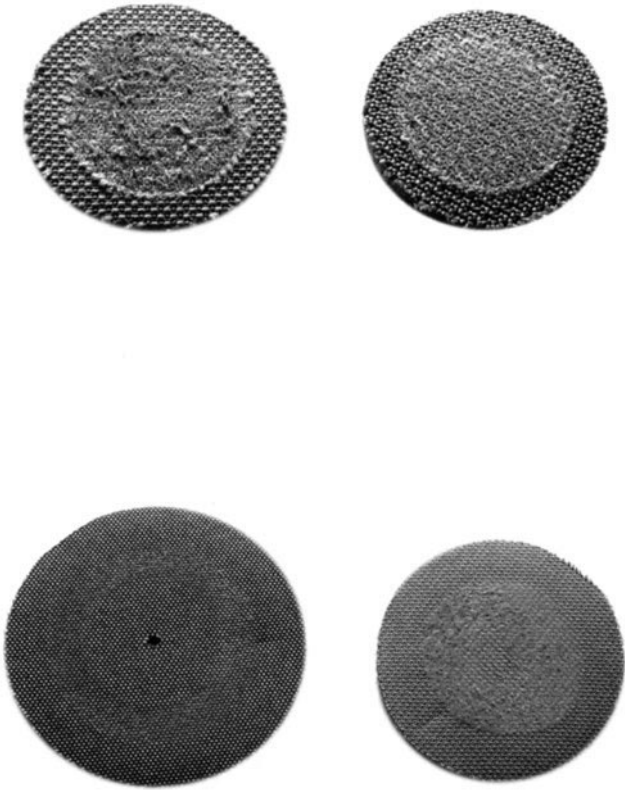

5.6 Abrasion testing of automotive seat cover fabric. The top two were abraded on the Martindale apparatus. The top left sample shows broken threads and some pilling. The right hand sample shows some wear and 'frosting'. The bottom left sample has been abraded using the Taber apparatus and is satisfactory, while the bottom right, abraded on the Schopper apparatus is showing signs of wear. Note; The photographs are not to scale, the Martindale samples are about 4cm across, the Taber samples about 13cm and the Schopper samples are about 11cm.

effect on surface abrasion. Those constructions with long 'floats' or which otherwise provide points for frictional stress, have the poorest abrasion. Fabric finishes can significantly improve abrasion, by acting as a lubricant in the abrading action, or as a barrier between the fabric and the abrading material. However they are rarely used on automotive fabrics because of the risk of fogging and also because they could lead to the development of unsightly or sticky deposits on fabric surfaces over a period of time, probably caused by degradation of the chemical by heat, humidity and light radiation. In addition drops of water could lead to the appearance of 'tide' marks or discoloration. Certain waxes and silicones in particular must be

avoided because they can affect adhesion of foam during lamination. The most common method of improving abrasion resistance of woven fabrics is by coating the back of the fabric with an acrylic or polyurethane resin. Anti-abrasion finishes are also available which can be applied either by padding or directly to the surface of fabric by foam coating. After testing by the prescribed method, the abraded samples are inspected for wear or broken threads. A certain amount of wear is usually acceptable but most OEMs will not accept a broken thread.

#### 5.2.5.1 *Frosting*

In some instances the material may not have any significant wear or any broken threads after abrasion testing, but may be whiter in appearance. This condition is referred to as 'frosting' or 'ghosting' and is sometimes associated with fibrillation of the yarns and sometimes with poor dye penetration. In other cases, especially if a finish has been applied to the face side of the material, the abraded pattern may be glazed and appear shiny. These defects may or may not be acceptable to the seat maker or OEM.

#### 5.2.5.2 *Pilling*

Also associated with abrasion resistance is pilling, which is the formation of little circular clusters of fibre on the surface of the fabric, produced as a result of the fabric being rubbed against itself or against some other material. It is believed that fibre ends become tangled and twisted together sometimes with the fibre ends and broken threads of the material it is being rubbed against. A number of papers are available on pilling phenomena.<sup>22-25</sup> Unsightly pilling can occur where the seat occupants' clothing is perhaps more to blame than the seat fabric itself. This is sometimes referred to as 'foreign' pilling.<sup>22</sup> Fabrics constructed from spun yarns are significantly more prone to pill than continuous filament, and the problem is probably more pronounced with polyester than wool. Wool is an inherently weaker fibre and pills can break off from the fabric surface before the end of the test cycle. This does not always happen with polyester because of its higher strength and the pills grow larger, become more conspicuous and unsightly, and unlike wool are present at the end of testing and are assessed. Thus misleading results, which do not reflect actual wear may be obtained.

Pilling can be minimized by chemical finishes, increasing the yarn filament thickness, use of higher twist yarns and by brushing and cropping of the fabric. However any one of these factors may change the handle and other qualities of the material.

Fabric is sometimes tested for pilling using a pill box of the type designed by ICI. This consists of twin wooden cubic boxes, each with sides about



5.7 Atlas Random Tumble Pilling Tester. Photograph supplied by SDL International and reproduced with kind permission.

25 cm long, the inside walls of which are lined with cork. Fabric samples are wrapped around rubber formers and placed inside the boxes, which are then rotated around a common axis for a measured length of time. The samples are assessed against masters and the degree of pilling assessed on a scale of 1 to 5, the higher the rating the less the pilling. In an alternative test method, the so-called Random Tumble Pilling Tester Method (ASTM D 3512), cotton fibres can, if required, be added as a source of foreign fibres, see Fig. 5.7. The Martindale tester is also used to assess pilling by subjecting the test fabric to cycles of say 1000 or more rubs and the number of pills counted.

### 5.2.5.3 Snagging

Snagging occurs when a sharp point or rough surface catches a thread in a knitted or woven fabric. Constructions incorporating long floats are especially prone to this problem. The thread is pulled out of the fabric forming a small loop on the surface, and the thread still in the fabric, is stretched

and appears as a shiny line – a tight end. The phenomenon of snagging is tested using a Mace snag tester which comprises an array of spiked metal balls. These are abraded against the fabric for a set time and the degree of snagging assessed on a 1 to 5 scale.

### 5.2.6 Peel bond tests

Peel bond tests on the cover laminate, face fabric to foam and foam to scrim are important to ensure delamination does not occur in the car during use or during downstream processing. Samples are taken and tested both in the warp (lengthways) and weft (width) direction. To simulate possible conditions which may be encountered during the life of the car and during subsequent processing, the peel bond test is carried out as received, and also after heat ageing, while wet, and sometimes after treatment with solvents. Peel bond tests are usually carried out on a universal strength testing machine controlled by computer software, the rate of separation being specified, see Fig. 5.8. Again the actual test procedures vary according to the method specified by the OEM and the standard required (expressed in Newtons per centimetre width of sample) is also specific to the particular OEM. The direct joining of seat cover to the foam squab and cushion may necessitate higher peel bonds because there are fewer sew lines to help hold the laminate components in place. The negative influence of fabric finishes, especially silicones on peel bond, has already been mentioned.

### 5.2.7 Fogging

Fogging is the mist-like deposit that forms on car windscreens reducing visibility and sometimes is difficult to remove, even with soap and water. Fogging, is caused by volatile materials vaporizing out of *all* interior trim components, such as plastic foils, polyurethane foam and not just the fabric. Modern polypropylene foils hardly fog at all, but PVC, if not formulated with suitable plasticizers, can fog quite badly. Fabrics if not stentered well or scoured can fog very markedly due to the multiplicity of lubricants applied during dyeing, yarn doubling, warping, weaving, knitting and finishing. Velvets or other pile fabrics can fog very significantly because of the much larger surface area of yarn on the face of these fabrics. Chemical analysis of the fogging deposits have been attempted and published along with other findings.<sup>26-32</sup>

The fog test is carried out by putting a specified amount of fabric into a beaker, which is covered and sealed by a glass plate. The light reflectance of the glass plate is measured beforehand. Because the ‘non-tin’ side of the glass plate must face downwards towards the material being tested, which side is which, must be labelled by the supplier. This glass plate is cooled by

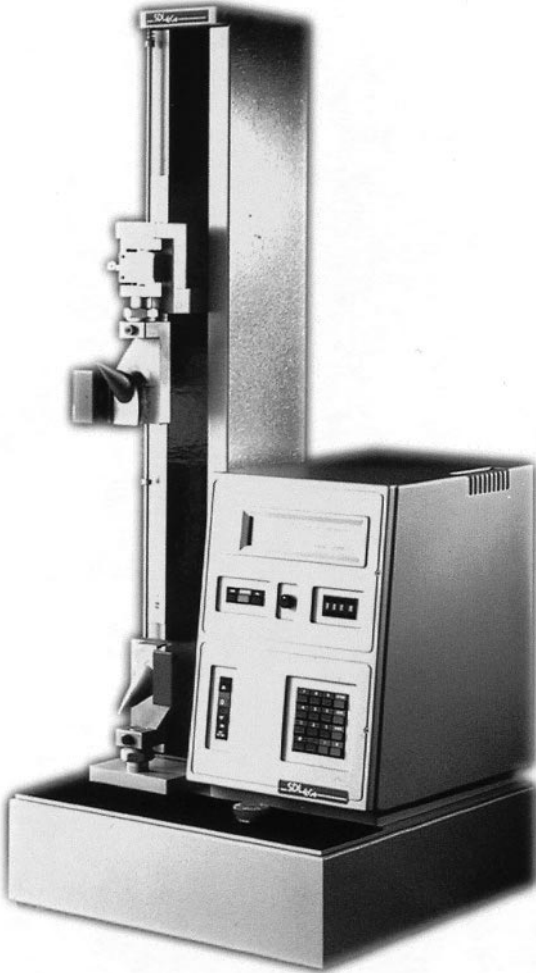

**5.8 Universal Strength Tester.** This machine is used for determining tensile strength, tear strength, peel bond, stretch and set and other physical tests. Different clamps and jaws are needed for different materials and the rate of separation of the jaws are generally computer controlled.

a metal cooling plate which rests on it, and cooling water is pumped through it at a specified temperature, usually room temperature, see Fig. 5.9. The beaker is heated at 90 to 110°C for 3 to 6 h; the actual conditions being specified by the OEM. After this time, the light reflectance of the glass plate is re-measured to determine the reduction in reflectance, which has been caused by condensation of the volatile materials from the test sample. This is usually expressed as a percentage of the original reflectance and a good

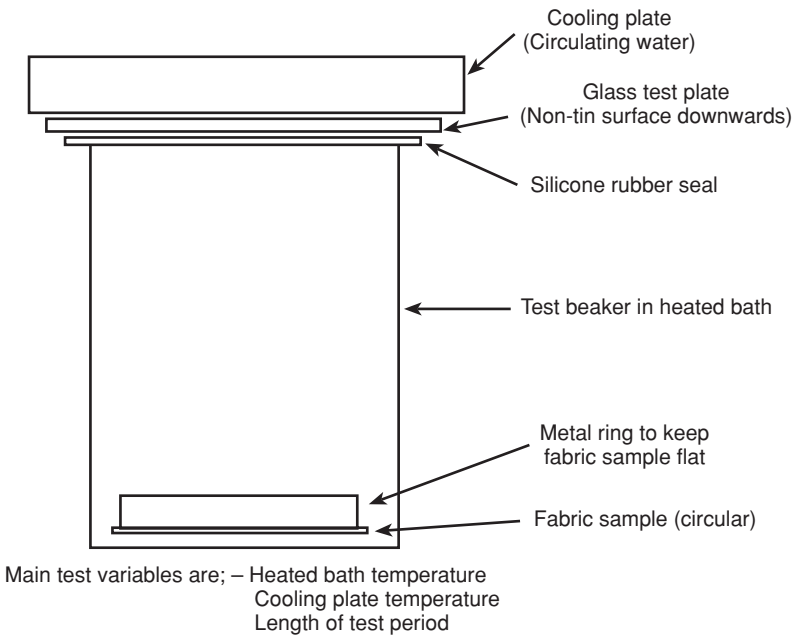

5.9 Automotive fabric fogging testing.

result is generally anything over 90%, although some OEMs may specify considerably less than this value. The three main test parameters, i.e. temperature of sample heating, time and cooling water temperature are specified by the OEM. Before any actual determinations are carried out, the whole apparatus is checked by measuring the fogging obtained with DIDP (di-isodecyl phthalate), a plasticizer used in PVC, which should be in the region of 76–9%. Depending on the information supplied by the manufacturer, e.g. Merck, this check should be carried out periodically about once a month but some test houses include a DIDP standard with every test batch.

Problems have been experienced in obtaining inter-laboratory reproducibility and much discussion has taken place to standardize procedure aimed at improving this. Cleaning of the glass plates is generally believed to be critical. Some researchers however believe that a gravimetric method, which weighs the volatile deposits, is more satisfactory, but this method relies on a balance capable of weighing to five places of decimals. More recent work has focused on the formation of crystals on the glass plate, which may still reduce visibility but give a high reflectance reading. Two test rigs are widely used, those made by Haake and Hart, but the test specifications are written in such detail that self-assembly is possible. Operative procedure is believed to substantially influence the accuracy of the test and

the methods to be used are detailed in the test specifications. A video has been produced by the Industrial Fabrics Association International to assist with training to carry out SAE J1756.

Fogging has assumed more importance recently and is related to the problem of mal-odours in new cars, being caused by volatile materials. The whole subject of air quality inside cars is now under examination – see the section below on odours and the section on cabin air filters in Chapter 7.

### 5.2.8 Antistatic properties

The problem of static shocks when getting out of cars has been known for some time, and a small number of OEMs have for some time required anti-static finishes on their car seat covers.<sup>33–36</sup> Static electricity, is generated by the person's clothes rubbing over the polyester car seat cover, especially when he or she stands up to get out of the car. Some individuals seem to be especially prone to static shocks, which are also influenced by the clothes and shoes worn and also the ambient air conditions inside the car. The polyester seat cover is hydrophobic, i.e. containing very little moisture to conduct away or help dissipate the static electricity. However, many OEMs at the present time do not specify any particular finish. Antistatic properties are easily conferred on the fabric by application of an antistatic finish by padding, or by foam coating, but these finishes are not permanent and eventually wear off. Their efficiency is measured by surface conductivity methods and they work simply by their hydrophilic nature, which ensures that a small amount of moisture is always present on the car seat surface.

It is especially important that fabric samples are conditioned in the laboratory before testing and that the laboratory temperature and relative humidity conditions are correct. The conductivity meter actually measures surface resistivity in units of ohms. A resistivity of about  $1 \times 10^{10}$  ohms is considered a reasonable level of antistatic behaviour, but the lower the better. Padding a fabric with a good antistatic agent can easily give a figure of  $1 \times 10^7$ . The surface conductivity method has its limitations and some researchers question its suitability for car seats. Some OEMs and research institutions such as the British Textile Technology Group (BTTG) and John Chubb Instrumentation have developed whole chair tests which are carried out by human subjects wearing specified clothing.

Very recently, concern has been expressed about the possibility of static electricity interfering with electronic equipment controls in the car and even the possibility, in extreme cases, of igniting petrol vapours.<sup>35</sup> There has been renewed interest in development work using conductive yarns such as Negastat (DuPont) and R. Stat. which can confer permanent antistatic properties to the car seat fabric. These specialist yarns are very expensive but

only small amounts are required in a fabric to confer some measure of durable antistatic behaviour.

### 5.2.9 Flammability

The test used by most OEMs is the USA standard FMVSS 302, a horizontal burn method, but the test performance standard required varies according to the OEM. Generally this test, see Fig. 5.10, is not especially difficult to pass, but sometimes a flame-retardant coating is needed on the fabric or a flame-retardant foam is necessary. Sometimes both are required to satisfy the test standard. Flame-retardant chemicals both in the foam and the coating add to the cost and for commercial reasons the concentration levels in both foam and coating are kept to a minimum. A fabric coating can cause stiffening as well as adding to the overall weight and cost.

The antimony trioxide/bromine synergy combination is still widely used in coating formulations although the organic bromine compounds have come under scrutiny as environmentally unfriendly and possible health hazards. Alternative compounds are available, but they are believed to require higher concentrations and therefore higher add-ons of coating, with all the disadvantages, for the same performance.

Flammability is assessed by the burn rate, which is the distance in centimetres burnt in 1 min. The burn rate regarded as acceptable varies accord-

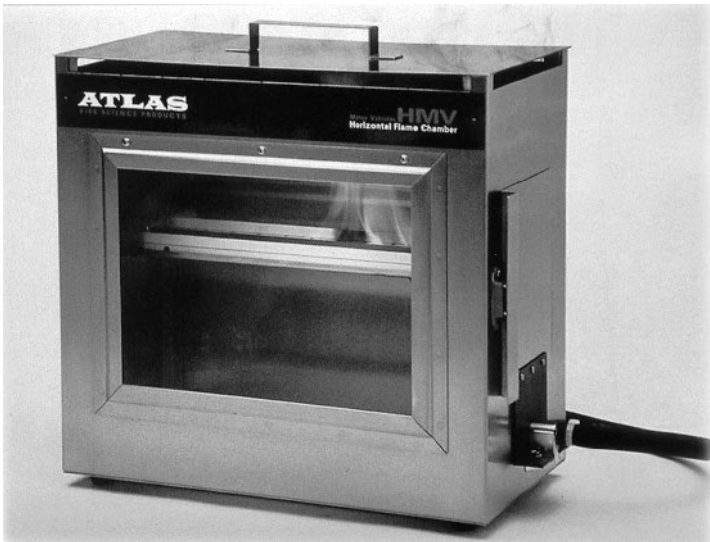

5.10 Apparatus for automotive fabric testing. Most car interior trim fabrics are tested using methods similar to the US FMVSS302 horizontal burn test.

ing to the OEM. Door panel fabric is usually assessed on the actual door panel itself. Variations in flammability test results are sometimes caused by uneven up-take of fabric finishes or variations in scour or stentering. Stentering may influence the flammability of stretchy knitted fabrics because it could affect the manner in which the fabrics shrink away from the flame. Some OEMs require that pile fabrics be brushed in a particular way before testing.

Flammability is an especially important test for public passenger vehicles, aircraft and boats and ships and a fuller account of this subject is in Chapter 9. The tests and performance standards are much more severe than the requirements for private cars and much use is made of flame-retardant varieties of polyester and more specialist fibres. The cost of these specialist fibres would be prohibitive for general use in private cars at present.

### 5.2.10 Dimensional stability

Fabric laminates are examined visually for curl and other dimension stability tests involve measuring the percentage shrinkage after soaking in cold water and heating in an oven for several days at various temperatures. Efficient heat setting during fabric finishing significantly reduces thermal shrinkage. Figure 4.7 shows the general relationship between heat shrinkage and heat setting temperature with polyester fabric.

As previously mentioned some of these tests have assumed more importance recently with the newer methods of manufacture and high production rates, which do not allow for continual machine adjustments. Lamination must be carried out under conditions of no tension if the products are to pass these tests consistently. In especially poor cases, the fabric laminates curl, usually because the foam or scrim has been stretched during lamination, and accurate cutting is impossible. Stretch and set tests, see below, are also carried out to screen material for these potential problems.

### 5.2.11 Stretch and set

These properties are important in fabrication of the interior component. After panel cutting the material may elongate under its own weight and may then be longer than another piece cut to the same size to which it is being sewn. An oblong shape may need to be folded around into a cylinder shape, say for a headrest and one edge may be slightly longer than the other. Another fabric panel may require pulling around a seat cushion or squab and it may not be possible to do this without the use of undue force. Conversely it could be too loose or too stretchy and this would cause bagging and creasing during use. These pieces would be rejected because

they could not be used – there is no time to trim them to the correct size. Stretch and set are determined by testing strips of fabric of specified dimensions at specified rates of extension on a computer-controlled universal strength tester.

### 5.2.12 Soiling and cleanability

These factors are assessed by the application of materials likely to be accidentally spilt on to the surface of car seat fabric. They are applied to test pieces of fabric in the laboratory and then cleaned off using a specified procedure. The degree of soiling left behind is assessed under a standard light source such as CIE D65 (chosen as closely resembling natural daylight), and either compared to standard patterns or assessed using Grey Scales. Rating 5 of the Grey Scale records no noticeable staining, 4 records slight staining, descending down to rating 1, which records very significant staining. The soiling agents include materials such as chocolate, coffee, tea, ice cream, hair-dressing fluid and engine oil. A brand name or chemical type of soiling agent is usually specified for the tests to be reproducible. Antisoiling seems to be an increasing concern and there have been recent reports on the subject.<sup>37,38</sup>

Water repellency is tested by pouring a measured amount of water on to the fabric held at an angle of 45 degrees from a funnel and assessing the drops adhering to the fabric using standards.

The problem of ‘linting’ or appearance of white specks of fibrous material on the car seat is well known and is quite difficult to overcome. These ‘lints’ are not easy to remove by brushing and tests have been carried out to minimize the problem using certain soil-release agents. Associated with linting is ‘minking’, the removal of hairs from fur coats by abrasive action of the car seat fabric. Some OEMs require the tendency of these problems to occur to be assessed by specified test procedures.

### 5.2.13 Environmental and ageing

These tests try to reproduce several years’ ageing in the space of one or two weeks in the laboratory. They are important for picking out poor adhesive bonds, which may allow fabric to lift or ‘bridge’ in mouldings with sharp angles or corners. Shade change, dimensional stability and peel bonds are also examined after ageing. Typical tests involve exposing the sample to heat for about two weeks at over 100°C and to relative humidity at 100%. Environmental tests are generally carried out on the component as a whole e.g. an entire completed door casing. The tests frequently involve a complete cycle of extreme conditions e.g. exposing the test piece to say, 24 hours at –40°C, then to say, 24 hours at 100°C and 100% relative humidity.

### 5.2.14 Fabric handle, drape and stiffness

Fabric stiffness is assessed by a bending length tester of the type designed by the Shirley Institute (now BTTG). Fabric stiffening, especially as a result of back coating is usually accompanied by a reduction in tear strength. This should be remembered especially when dealing with lighter-weight fabrics.

Some efforts have been made to quantify surface touch using the Kawabata system, which has been used with some success in the clothing industry.<sup>39–43</sup> For automotive fabric the quantities relating to drape and flexing are not relevant but the tactile surface touch properties are important. However, this work was done by a research institute and does not appear to have been followed up by an OEM or seat maker. Research on fabric handle of apparel and household textiles has revealed national preferences for touch properties and softness. For automotive textiles where the fabric is fixed to a seat, door casing or headliner, the only relevant mechanical properties out of the five specified by Kawabata are probably compression and surface properties.

### 5.2.15 Fabric strength – tear and tensile

Good tear strength and resistance to tear propagation are important for car seat fabric, which is expected to last the life of the vehicle. Torn seat fabric would deter prospective purchasers and significantly reduce the resale value of used cars. The tearing strength is influenced by the smoothness of the yarns and the construction as well as by the thickness of the yarns. If the construction is rigid and inflexible, the applied force breaks the threads one at a time and low tear strength is obtained. A fabric coating which penetrates the fabric structure and holds the threads in place, will generally cause stiffening in addition to a lowering of tear strength. If the threads move under the tearing force, and bunch together, several threads will be broken together, producing a higher tearing strength. Some fabric lubricants will allow this to happen, and it is more likely if yarns have a smooth surface. Care must be exercised however because lubricants and finishes can reduce peel bonds if the fabric is to be laminated. In fact, silicone finishes can significantly improve tears strength – but these are *not recommended* on automotive fabrics because of their effect on adhesion and because they can contaminate surfaces to be painted. Certain constructions such as twill weaves allow threads to group together more easily and thus tend to have better tear resistance than plain weaves. The yarn and fibre type also determines fabric strength; polyester is stronger than wool and continuous filament yarns will be stronger than those made from spun staple fibre. Tear-strength testing is also sometimes required after exposure to UV light. Polyester fabric tear strength is generally satisfactory after

exposure, but that of wool fabrics may be significantly lower. As has been noted, yarn lustre has a significant effect, see Table 1.3.

There are a number of tear tests in use, single rip, wing tear and Elmdorf tear. The wing tear avoids transfer of tear, whereas the Elmdorf method measures energy loss during the tear process. Care must be exercised in clamping the specimen in the jaws of the test machine because any slippage could be mistaken for a tear or a failure of the test specimen. Jaws and clamps of different designs are available for different types of materials to be tested. Straight load or tensile strength tests on strips of fabric are useful for investigating the effect of a material or process change on fabric properties. Certain knitted fabrics may distort or unravel and bursting strength tests are likely to be more reliable.

#### 5.2.16 Fabric strength – bursting

This test is more relevant to a knitted fabric or a non-woven where the test load is multidirectional. The fabric is clamped in the machine over a rubber diaphragm and pressure is applied via water or some other fluid, which during the test stretches the rubber and thus applies a force to the fabric. The exact procedure and diameter of the test specimen vary with customer requirements.

#### 5.2.17 Fabric strength – seams

This can be assessed by preparing a test seam, and attempting to separate the two sewn pieces using a universal strength tester. Special machines have been developed by some OEMs, which simulate continual forces of separation. Actual seam strength is generally satisfactory if a quality sewing thread is used, but opening of sew holes referred to as ‘seam fatigue’ must be checked with some constructions. The scrim on the back of the seat fabric laminate can be selected to contribute to the overall seam strength of the laminate and may even be critical with certain lighter weight and open construction woven fabrics.

#### 5.2.18 Air porosity and permeability

For automotive fabric laminates this is usually measured as the volume of air in litres per second required to maintain a specified constant pressure differential across a test specimen of a certain dimension. Test conditions specified by OEMs are generally similar to those in BS 4443: Part 6: 1980 Method 16. High material porosity makes panel cutting of several layers more trouble-free and accurate especially when a vacuum is used to hold material flat down on the cutting table. Porosity also influences seat

comfort, see below. Porosity has become more important recently as a measure of laminate suitability for 'foam-in-place' manufacturing methods. When the materials are of much lower air porosity, the Gurley Method, which is used widely for packaging materials is specified.

### 5.2.19 Comfort – breathability

This quality is a measure of the permeability of a material to human perspiration and can thus provide some indication of the possible effect on thermal comfort of the car seat which incorporates the material. At present there are no breathability test requirements for the fabric producer, but they may be relevant for the seat manufacturer to carry out on the seat as a whole, especially when a direct joining technique has been used. The ultimate test is the sweating hot plate test developed by the Hohenstein Institute in Germany but some information can be obtained by simpler tests, which are less expensive. These include evaporative tests such as ASTM E-99 B, BS 7421 and the Turl Dish test. Films including adhesive films, barrier films or other materials to be used in novel methods of seat manufacture can be checked for breathability to ascertain whether or not they could give rise to thermal discomfort. However it is important that they are compared with materials known to have acceptable levels of breathability to human perspiration such as, Goretex (WL Gore), or Sympatex (AKZO) membranes. The most meaningful tests are however carried out on whole chair assemblies. Numerous other factors need to be considered and seat comfort is discussed in more detail in Chapter 6 together with some data on breathability of materials.

### 5.2.20 Odour assessment

Many OEMs simply state that the material must be free of any unpleasant odours but this issue is likely to become more important in the future as concerns with health and safety increase.<sup>44</sup> Within the last 2 years Fords have introduced an 'electronic nose' to detect and measure odours.<sup>44-46</sup>

### 5.2.21 Recording of results – statistical process control

All results must be recorded and filed for a reasonable length of time so that if any problems occur in down-stream processing, the incident can be investigated. The results of individual tests are plotted on to a statistical process control (SPC) chart and it is possible to see, at a glance, how consistently the product is being produced. Sudden changes in test results, trends and recurring cycles can sometimes give clues as to what is happen-

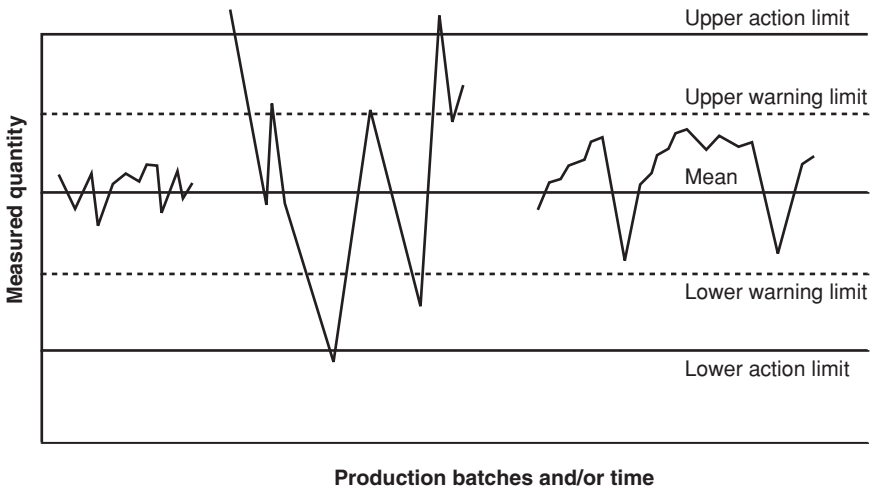

Process in control

Process out of control

Trends and sudden movements

Warning limits can be mean plus/minus  $2\times$  standard deviations.

Action limits can be mean plus/minus  $3\times$  standard deviations.

Statistical Process Control provides a method of detecting faults during production, as a way of continuous improvements with the objective of achieving zero defects.

#### 5.11 Statistical Process Control production chart.

ing if there is a problem, see Fig. 5.11. If the results are within acceptable limitations, it is known that the process is in control. If results begin to deviate significantly from the mean, this may be taken as a warning that something may have happened, and corrective action may be needed. If the 'warning' limits are set at the mean value  $\pm 2$  standard deviations, 'action' limits are usually set at the mean  $\pm 3$  standard deviations. This technique allows quality to be checked while the component is being made and not after completion when it is usually too late. The philosophy is not to detect faults after production has been completed, but rather the prevention of faults occurring during production, as a means of continuous improvement with the objective of achieving zero defects.

#### 5.2.22 Fabric examination

Every metre of laminated fabric must be examined carefully before it leaves the factory to go on to the next stage of manufacture. Trained examiners carefully inspect the material for: width; shade/pattern regularity; lamination faults, e.g. delamination; oil marks or other soiling; weaving or knitting faults; handle/drape/stiffness; joins in foam or scrim; and any other faults

which could cause complaints from customers or problems in downstream processing.

Faults are marked with a coloured tag or label and a length allowance is given to the customer. Usually the faults are colour coded. However even experienced examiners cannot see all faults at practical, commercial examination speeds and ways of improving this situation are always under consideration, for example, better quality examination frames, better illumination, etc. Some OEMs specify the speed at which the material is examined – the slower the speed the better the chance of seeing all faults. The examiners also measure the length of fabric and put it on to rolls of the required size for despatch.

Automatic examination systems can pick out basic construction faults, tears, creasing, etc. but more sophisticated apparatus is necessary to identify every possible fault especially pattern distortions. As previously stated, technology which is capable of doing this, probably does exist, but the actual problem in reality is making it affordable.

### 5.3 References

1. Pickett D (General Motors), 'Challenges for 10 year automobile textile service durability', *IMMFC*, Dornbirn, 17–19 September 1997.
2. Taylor HM, 'Physical testing of textiles', *Textiles*, 14 (1), 1985, 21–8.
3. Park J, 'The technology and production of fabrics for the automotive industry', *Review Progress in Coloration*, 1981, 11, 19–24.
4. Milligen B, 'The degradation of automotive upholstery fabrics by light and heat', *Review Progress in Coloration*, 1986, 16, 1–7.
5. Horsforth A, 'One big technical headache on wheels', *JSDC*, May/June 1992, 108, 243–6.
6. Parsons MA (Rover), 'Fabric requirements for automotive use', *Autotech*, Seminar 9, NEC, Birmingham, 1991.
7. Kowalski M (Guildford), 'Automotive fabric presentation', *Autotech*, Seminar 9, NEC, Birmingham, 1991.
8. McCallum JB (Ford), 'Engineering requirements for automotive textiles', *Automotive Textiles* (ed. M Ravnitzky), PT-51 SAE, Warrendale, PA, USA, 1995.
9. IWS Interior Technical Information Letter No 31, 'Technical specifications for automobile industry', August 1986.
10. IWS Interior Technical Information Letter No 32, 'The Styling and performance of wool automotive upholstery', September 1986.
11. Rink GS (Opel), 'Harmonisation of textile testing in the German automotive industry', *IMMFC*, Dornbirn, 20–2 September 1995.
12. Weber E (Opel), 'Harmonisation of test procedures of automotive textiles; influence of globalisation', *IMMFC*, Dornbirn, 15–17 September 1999.
13. Card AH, 'The road to harmonisation', *Financial Times World Automotive Manufacturing Monthly Analysis*, Issue 2, June 1998, p. 4.
14. Butts K (Datacolor), 'Colour tolerances for consistent pass/fail decisions', *AATCC Symposium, Yarn Dyeing '96, Meeting the Challenges*, 18–19 April 1996, Sunset Beach, NC, AATCC North Carolina, 1996.

15. Wootton A, 'Light fastness and weathering tests in the automotive industry', *JSDC*, 108 May/June 1992, 239-42.
16. Hibbert M, 'Throwing light on automotive trim testing', *JSDC*, 108 May/June 1992, 253-5.
17. Watanabe Y (Nissan), 'Estimation of the light durability of automotive interior materials with the value of equivalent total sunshine energy', *Automotive Textiles*, PT-51 (ed. M Ravnitsky), SAE, Warrendale, PA, 1995, 13-20.
18. Bird LA (Heraus), 'USA automobile testing yesterday, today and tomorrow', *Automotive Textiles*, PT-51 (ed. M Ravnitsky), SAE, Warrendale PA, 1995, 31-8.
19. Smith TL, 'Taking the heat', *Automotive and Transportation Interiors*, June 1996, 32-5.
20. Park J, 'Assessment of fastness properties', *Review Progress Coloration*, 1979, 10, 20-4.
21. Midwest AATCC Section Committee, 'Accelerated lightfastness testing of disperse dyes on polyester automotive fabrics', *Textile Colorist & Chemist*, December 1993, 25 (12), 25-32.
22. Bachor M, Lampe T & Brinkmann A (VW), 'Foreign pilling of car upholstery caused by external influences such as clothing materials', *Textiles in Automobiles*, VDI Congress, Dusseldorf, 14-15 October 1992.
23. Francke G & Henkel A, 'Friction wear on car upholstery materials, causes and possibilities of avoiding it', *Textiles in Automobiles*, VDI Congress, Dusseldorf, 14-15 October 1992.
24. Hurten J, 'How pilling in polyester weaves can be controlled in the finishing process?', *Textil Praxis International*, (33), 1978, 823-36.
25. Bosch M, 'Pilling on textiles, fundamentals, extent of influence and test procedures', *Textiles in Automobiles*, VDI Congress, Dusseldorf, 14-15 October 1992.
26. Baetens E & Albrecht E, 'Fogging characteristics of automotive textiles', *Textextil*, Frankfurt, 14-16 May 1991.
27. Baetens E & Albrecht E, 'Reducing the fogging effect in cars', *TuT*, 1992, 4, 42-4.
28. Hardt P, 'Estimation of the amounts of volatile substances as applicable to stenter frames for automotive fogging', *IMMF*, Dornbirn, 22-4 September 1993.
29. Behrens W & Lampe T (VW), 'Fogging behaviour of textile materials', *Textiles in Automobiles*, VDI Congress, Dusseldorf, 30-1 October 1991.
30. Ehler P, Schreiber H & Haller S, 'Emissions from textiles in vehicle interior trim causes and assessment of short term and long term fogging', *IMMFC*, Dornbirn, 22-4 September 1993.
31. McCallum JB, 'Ford Motor Co develops its own test method for predicting light-scattering window film', *Textile Col & Chemist*, December 1989, 21 (12), 13-15.
32. Behrens W, 'Fogging behaviour of car interiors', *Technische Textilien*, 36 1993, E25-7.
33. Anon, 'Kanebo car seat cloth', *JTN*, June 1986, p. 59.
34. Anon, 'Kanebo, Bellatron conductive fibre', *JTN*, May 1991, 86-7.
35. Lennox-Kerr P, 'Reducing static shock', *Inside Automobiles International*, October 1998, 20-1.
36. Hall P, 'Motoring'. *Daily Telegraph*, May 14 1994, p. 15.
37. Finke H, 'Antisoiling treatment of automotive fabric from the viewpoint of the user', *Textiles in Automobiles*, VDI Congress, Mannheim, 25-6 March 1998.

38. Hilden J, Msiyah M & Niederrhein FH, 'Antisoiling finish for polyester car upholstery, effects and problems', *IMMFC*, Dornbirn, 15–17 September 1999.
39. Kawabata S & Masako N, 'Fabric performance in clothing and clothing manufacture', *J Textile Institute*, 1989, 80 1, 19–50.
40. Kim CJ, 'The Kawabata System use in the fabric hand and evaluation of automotive textiles', IFAI Symposium, *2nd International Conference on Automotive Test Procedures*, Atlanta, 1992.
41. Harwood RJ, Weedall PJ & Carr C, 'The use of the Kawabata evaluation system for product development and quality control', *JSDC*, 106, February 1990, 64–8.
42. Stearn AE, D'Arcy RL, Postle R & Mahar TJ, 'Statistical analysis of subjective and objective methods of evaluating fabric handle', *Journal of the Textile Machinery Society of Japan*, 1988, 34 (1), 13–18.
43. Hearle JWS, 'Can fabric enter the dataspace? Part 1', *Textile Horizons* 13 (2), April 1993, 14–16, and Part 2, *Textile Horizons* 13 (3), June 1993, 16–20.
44. Luessmann-Geiger H (Audi), 'Emissions from vehicle interior components containing textiles and how to reduce them', *IMMFC*, Dornbirn, 15–17 September 1999.
45. Kennerley S, Jones D & Gagne W (Aromascan), 'Electronic nose helps quantify odours in PU foams and raw materials', *Urethanes Technology 1998*, October/November 1998, 40–2.
46. Sassmannshausen J, 'The electronic nose: more than just an instrument for objective olfactory', VDI Congress, *Textiles and surfacing materials in automotive engineering*, Mannheim, 25–6 March 1998.

## 5.4 Further reading

1. 'AATCC Technical Manual', North Carolina, USA AATCC, 1995.
2. 'ASTM Annual Book of ASTM Standards' (vol 7.01/7.02 – which relate to textiles), ASTM, Philadelphia, PA, USA.
3. Booth JE, 'Principles of Textile Testing', 3rd edn, London, Heywood, 1968.
4. Corless MG, (BTTG), 'How to remove stains', *Textiles*, 14 (1), 1985, 13–16.
5. ISO 9000 series. Quality management systems, 1994.
6. Kelly JM, 'Quality Assurance in the Knitting Industry', Abington, Cambridge, Woodhead, 2000.
7. McDonald R (Editor), 'Colour for Industry', 2nd edn, Bradford, Society of Dyers and Colourists, 1997.
8. Mahall K, 'Quality Assessment of Textiles; Damage Detection by Microscopy', Berlin, Springer-Verlag, 1993.
9. Merkel RS, 'Textile Product Serviceability', New York, Macmillan, 1991.
10. QS9000, 3rd edn available in North America from AIAG on 01-248-358-3003; outside North America from Carwin Continuous Ltd., West Thurrock, Grays, UK. +44 (0) 1708 861333.
11. Ravnitsky M (ed.), 'Automotive Textiles', SAE PT-51, Warrendale, PA, SAE Inc., 1995.
12. Ross JE, 'Total Quality Management', London, Kogan Page, 1994.
13. SAE Automotive Textiles and Trim Standards Manual (SAE HS-2700), Warrendale PA, USA, SAE Inc. 1996.
14. Saville BP, 'Physical Testing of Textiles', Abington, Cambridge, Woodhead, 1999.

15. Slater K, '*Physical Testing and Quality Control*.' Textile Progress 23 1–3, Manchester, Textile Institute 1993.
16. Taylor MA '*Technology of Textile Properties*', 3rd edn, London, Forbes, 1990, 163–244.
17. Wetherill GB & Brown DW, '*Statistical Process Control*' London, Chapman and Hall 1991.

## 6.1 Introduction

Modern methods of production are revolutionizing the industry, but they have also brought fresh challenges to the fabric producer. Specifications governing fabric and fabric laminate consistency are becoming more exacting. The more established standards for dimensional stability and for requiring the fabric to lie flat, so layers of material can be cut accurately, have been joined by additional requirements such as porosity, thickness and tighter tolerances all round. This is because moulding techniques usually applied to plastics, are being adapted to produce car interior components on a large scale. Usually heat is applied in a moulding operation or to activate hot-melt adhesives but polyester fabric being thermoplastic is vulnerable to thermal damage during these operations. The fabric is especially at risk because it is invariably textured or surface raised when used for car interiors.

The automotive industry has become so competitive that manufacturers are reluctant to divulge precise details of their process for fear that it could be helpful to their competitors. This is true of almost any industry but probably more so of the automotive industry at the present time. Mass production methods are still being evolved, developed and refined to suit particular circumstances and frequently changing requirements. These factors add to the already intensely competitive nature of the industry. The information contained in this chapter is therefore of a general nature and is what is already in the public domain. Basic scientific principles and material properties however do not change, and it is hoped that knowledge of these will help in future design, and also in problem solving. Details of the materials used and some properties appear in Tables 1.4, 1.5, and 9.1. The effect of heat on the shrinkage of polyester fabric is shown in Fig. 4.7.

The car interior has grown very significantly in importance in recent years; the aesthetics factors have already been made clear. We are spending more time in cars, and comfort in all its forms, is now a major factor

that customers take into consideration when purchasing a new car. Textiles are essential for producing surfaces with an attractive appearance and soft touch but they also play an important part in sound and vibration insulation and, as will be seen in the next chapter, an increasing role in road safety.

## 6.2 Seats

### 6.2.1 Introduction

The seat is probably the most important item in the car interior. It is the first thing the customer sees when the car door is opened and he or she will probably instinctively touch it; there is only one opportunity to make the most of this first impression. The seat is also the main interface of man and machine and seat comfort is of paramount importance. The factors influencing driving comfort have been researched in detail, especially within the last 10 years or so, by the OEMs, foam manufacturers and university departments, who have studied the ergonomic aspects and sound and vibration factors on human health.<sup>1-2</sup> Seat comfort and safety have also been the subject of European-sponsored research projects involving OEMs, seat makers, fabric producers and universities.<sup>3</sup> Textiles have become by far the most widely used material in seat coverings and are beginning to be used in other areas of the seat in place of polyurethane foam. They are also used in a number of specialist cases in place of metal springs and the actual seat pan and seat back. The move to replace polyurethane foam is mainly driven by recycling, commonization of materials and disposal factors at the end of the car's life. The use of one material; polyester, in the face fabric, polyester non-woven in the cover laminate and polyester non-woven also in the seat squab and cushion, would certainly simplify recycling and disassembly. However there are several factors to consider that are difficult to overcome, as will be seen. New techniques to make seats, which is overall still a fairly labour-intensive process have been developed and some are being put into commercial use. However despite this, some automotive engineers hold the view that seat process development and materials innovation are the slowest moving sectors of the automotive industry.<sup>4</sup> Seating systems are amongst the most costly items in the car interior.

### 6.2.2 Methods of seat construction

The traditional method of seat making involves cutting and sewing of panels of the seat cover laminate (face fabric/foam/scrim) into a cover, which is then pulled over the squab (seat back) and cushion (seat bottom), and then fixed in place using a variety of clips and fastenings. This process is both time-consuming and cumbersome, and because it includes considerable



6.1 The modern car seat – designed for comfort and styled for attractive up-to-date appearance.

‘human element’, consistency of quality could be better, which is a cause for concern even with skilled operatives. Furthermore, this problem is becoming even more troublesome with modern highly contoured seats, see Fig. 6.1. Several attempts have been made over the years to find better ways using a variety of techniques.<sup>5</sup> Three-dimensional knitting of the seat cover is an option which so far appears to have had only limited usage.

#### 6.2.2.1 *Foam in place*

The ‘foam in place’ technique (also called ‘foam in fabric’ or ‘pour in foam’), was developed in the late 1980s and achieved considerable initial success, especially with the Ford Fiesta.<sup>6-8</sup> The method combined two separate processes into one; foam cushion and squab moulding with the fixing of the seat cover in place over the pre-moulded foam. Panels of the seat cover laminate were cut and sewn into a ‘bag’ and the liquid foam components were poured in. These liquids reacted together to form the solid foam, but to prevent the liquids seeping through the fabric cover laminate before the reaction was complete, it was necessary to include a polyurethane barrier

film into the cover laminate beforehand. It was believed that this polyurethane film reduced seat thermal comfort because the water vapour permeability of the films used was too low to allow the passage of human perspiration. For this and other reasons, this novel method of seat making was generally discontinued for large-volume production. However, the basic method is still used for smaller, less critical items such as headrests and armrests. These smaller items do not need polyurethane films to act as liquid foam barriers, because the actual liquid foam pressure in such small items is not as great as in a seat cushion or squab. Laminate foam of higher density or slightly lower porosity, or a non-woven scrim, is generally sufficient to prevent liquid foam strike through.

#### 6.2.2.2 *Direct joining techniques*

Several other methods have been developed based on directly joining the cover fabric laminate to the squab and cushion.<sup>9-11</sup> Direct joining is especially suited to seats with curvaceous contours and it also allows a reduction in the thickness of the laminate foam. There are many variations to the basic principle and both hot-melt adhesive films and solvent spray adhesives are used. Vacuum is applied to hold the components together, and the hot-melt adhesive is activated by steam or hot air. This general method is gaining in popularity because it removes some of the human variation factors (the least controllable) and generally produces a more uniform seat appearance. However there are still problems to overcome such as preserving the pile in velvets, and other raised or textured fabrics, and cover laminate thickness has become more important. Certain other quality control tests have become more critical such as cover fabric to laminate foam adhesion, which needs to be generally higher because there are fewer sewings in the new process, to help keep the two materials together. In addition alternatives may have to be found eventually to replace solvent-sprayed adhesives as environmental laws tighten. Changing production to this method requires investment in costly new equipment and specially made tools, and for this reason, the traditional methods are likely to be with us for some considerable time.

#### 6.2.2.3 *Hook-and-loop fastenings*

Newer, novel ways of joining components together are finding applications in the car. Hook-and-loop type fastenings, sometimes called 'touch-and-close', examples of which are the Velcro-branded products, which have been used in other industries for many years are especially suited to the car where ease of disassembly has become important. These fasteners are much stronger than many believe and can be used for permanent joins –

permanent, that is until the end of the car's life. These materials are generally made from raised, knitted nylon 66 although polyester is sometimes used. They have many applications in the car and a method of seat making has been developed, which has the advantage of producing sharp well-defined deep contours without any of the lifting or bridging problems that are sometimes associated with stretch fabrics. The hook part of the fastener is attached to the seat foam cushion and the loop part sewn to the cover. When brought together, a very strong join is produced.

#### 6.2.2.4 *Tunnel tie*

Hope Webbing Company of Rhode Island, USA, has introduced yet another new method of securing seat covers over the foam cushion. It features a specially designed sleeve through which a draw cord passes. The sleeve is sewn to the edge of the seat cover, which is then drawn over the foam cushion and the cover is secured by pulling the cord tight. For more complex seat forms the cord is drawn through small apertures in the sleeve and secured to the back of the cushion. Tunnel Tie is economical and simple to use without the need for hooks, 'hog rings' or plastic clips. It is also easier to disassemble, which could facilitate recycling, and seems to be especially suitable for detachable seat covers, which can be changed by the customer.

#### 6.2.2.5 *3-D knitting of car seat covers*

This highly advanced, computer-controlled knitting technique enables several conventional cut and sew panels to be replaced with just a single 3-D shaped piece.<sup>12-19</sup> The novel development originated in the Research Division of Courtaulds at Spondon, Derby from garment-making research. The objective was to knit garments in one piece, thus eliminating panel cutting and making up together with the associated cutting waste of up to 30%. The potential benefits for car seat covers were soon realized and General Motors became involved.

Initial progress was hampered by the mechanical flat-bed weft knitting machine controls and its jacquard card needle selection mechanisms, but these limitations were soon overcome by the appearance of the computer.<sup>13</sup> Now each needle is individually computer controlled to enable almost infinite colour combinations and design patterns. Car seat covers can be knitted in just one piece, the single item includes all tubes, flaps and tie downs necessary for direct fitting. The labour intensive stages of panel cutting and sewing of up to 17 individual pieces of fabric are reduced to just one or two with no cutting waste.

The 3-D technique allows considerable design flexibility and creativity. Computer-assisted design 'paint box' systems facilitate design themes;

visual appearance can be dramatically modified by changes in fabric construction, yarn type and colour. Logos can be accurately placed and design themes can cover two or more seats and can even include the door panels if so desired. The actual seat cover itself and the patterned fabric are developed simultaneously which reduces development time by months. The design-approval process is both shortened and enhanced by the ability to view the finished seat in 3-D form on the computer screen. Other benefits include rapid set up and dramatically reduced stock holding especially of end of model surplus. A new model cover, can be produced simply by changing the yarns, inserting a new floppy disk, and a new seat cover is available for fitting within minutes.

These 3-D seat covers were first used in Europe in the Vauxhall Rascal van and in the USA in the 1993 Chevrolet Indy Pace car. They are now being used in the General Motors (GM) electric car, EV1 and in the GM car, GEO Prism. Research work continues with a variety of different yarns to further develop the aesthetics and handle. The 25 or so 3-D world-wide patents relevant to automotive application were held by GM but the original inventors are mainly British and until recently continued their work at Spondon, Derby. In late 1998 the Lear Corporation acquired the seat-making facilities of the GM subsidiary company, Delphi.

## 6.2.3 Materials for seat making

### 6.2.3.1 *Alternatives for seat cover laminate foam*

Non-woven polyesters fabrics – especially those made from recycled fibres,<sup>20–24</sup> and novel knitted structure such as spacer fabrics, Kunit, Multiknit<sup>25,26</sup> and Struto<sup>27</sup> have been considered as substitutes for polyurethane foam in the cover laminate. Spacer fabric is essentially a knitting product with threads perpendicular to the plane of the fabric with a knitted layer each side. Multiknit is a continuous process, which makes fabrics from fibrous webs using Malimo knitting techniques (Karl Meyer). Kunit consists of a stitch layer with a pile on the top whereas Multiknit comprises two stitch layers with the pile in between. A novel development from the Czech Republic, Struto non-woven fabric, is produced from layers of fibre vertically lapped, see Fig. 3.36. Non-woven materials made from recycled wool and polyester have also been examined and are used commercially. Tests show that they have generally similar compression/strain characteristics to polyurethane foam, see Fig. 6.2. Materials based on polyester fibre all lose significant thickness when tested by the compression/strain test according to BS 4443 Part 1 Method 6A, even when the test is done at lower temperatures than that specified by the test.<sup>20,28</sup> See Fig. 6.3 and Table 6.1. This would not be noticed in thin layers say under 3mm thickness in the

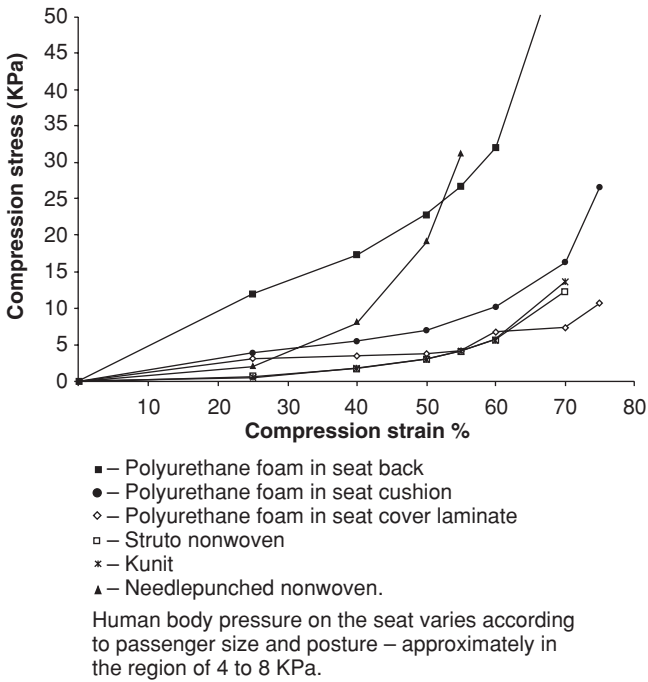

6.2 Compression stress/strain characteristics of some non-woven materials compared to polyurethane foam.

cover laminate but would be noticeable if used in thicker layers especially in place of the squab or cushion foam. BS 4443 however is a test designed for polyurethane foam, realistic tests for nonwoven fabrics used in this application are still to be established and standardized. The ‘touch’ of these materials is quite different from polyurethane foam however, and if this is a problem it is not likely to be overcome easily because of fundamental differences in material behaviour when compressed locally.<sup>29</sup> The foam has an isotropic structure (3-D) whilst the nonwoven made from a carded fleece is only two dimensional. The slight ‘scrunching’ sound when spacer fabrics are compressed or sat upon has also been commented upon.

### 6.2.3.2 Alternatives for seat squab and cushion foam

Several alternatives to polyurethane foam used in the squab and cushion have also been developed. DuPont have introduced polyester fibre ‘clusters’ which have a coiled and fluffed configuration. The clusters are put into a mould made of perforated metal and hot air is applied which bonds the clusters together. They can be formed into seat cushions and squabs in place

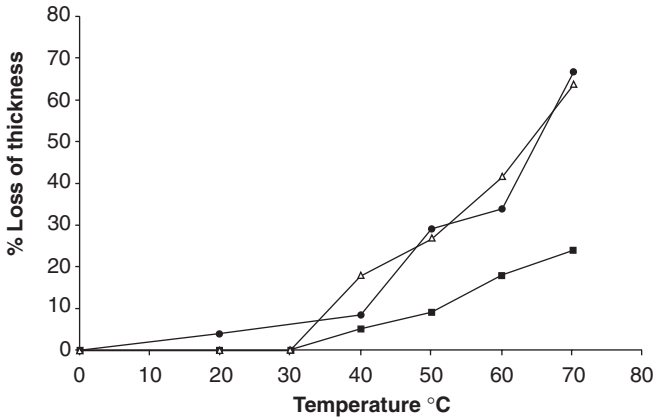

- – 22 Kg/m<sup>3</sup> density, thickness compressed by 75%
- ▲ – 54 Kg/m<sup>3</sup> density, thickness compressed by 67%
- – 54 Kg/m<sup>3</sup> density compressed under human body weight approximately taken as 8 Kg/100cm<sup>2</sup>

BS 4443 requires compression to 75% of initial thickness, holding for 22 hours at 70°C

### 6.3 Polyester non-woven materials; loss of thickness under load and temperature.

of polyurethane foam and the manufacturers claim weight savings of up to 30 to 40% compared to foam. DuPont also claim the same seating support, easier disassembly and recycling, and better comfort through increased breathability.<sup>30</sup> Very recently, Toyobo have launched a material called BREATH AIR described as random continuous loops of a thermoplastic elastomer; similar claims of comfort and recyclability have been made.<sup>31</sup> Natural materials referred to loosely as ‘rubberized horse hair’ have also been used. This fibrous matter, believed to include coconut fibre and pig’s hair as well as horse hair, coated with a rubber, provides good body support, has high porosity and breathability and is also claimed to be easily recycled. However it does not provide a smooth surface and the seat cover laminate foam or foam substitute must be relatively thick for a comfortable seat. In addition rubberized horse hair is said to be not a pleasant material with which to work.

All of these substitute materials are not as resilient as polyurethane foam especially when tested at higher temperatures in accordance to BS 4443 (see above), and lose significant thickness. The same considerations dis-

Table 6.1 Loss of thickness of some car seat materials

Material	% Loss of thickness after 22 hours 75% compression at	
	50°C	70°C
Polyurethane foams		
Regular ester density 28 kg/m <sup>3</sup>	6.6	7.1
Regular ether density 28 kg/m <sup>3</sup>	8.2	1.4
Reticulated foam (very open cell)	7.9	5.3
'Water Lily' ('greener foam') ICI	11.6	10.0
Non-wovens, all polyester		
'Struto' density 40 kg/m <sup>3</sup> (early sample)	33.0	50.0
Chemically bonded density 45 kg/m <sup>3</sup>	30.0	51.0
Needlepunched density 40 kg/m <sup>3</sup>	40.9	49.9
Other materials		
'Spacer fabric' (knitted polyester ex Karl Meyer)	30.7	45.7
Kunit – polyester	39.9	52.2
Kunit treated with silicone elastomer ex Dow Corning	—	65.0
Kunit treated with silicone elastomer ex Ciba Geigy	—	65.0
Multinit – polyester	50.7	61.8
Kunit made from recycled polyester	50.5	67.7
Natural rubber	6.9	30.1
Rubberized 'horse-hair'		
RG30 (low density) density 30 kg/m <sup>3</sup>	26.2	42.3
RG60 (higher density) density 60 kg/m <sup>3</sup>	39.0	46.2
Ecofil spheres DuPont polyester	—	50.0

NB: Test method BS4443 Part 1 (6A) requires compression to 75% of original thickness. This generally requires a force which exceeds human body weight.

cussed above relating to laminate foam alternatives also apply to the squab and cushion foam, see Fig. 6.2 and 6.3 and Table 6.1. Natural fibres, jute, sisal and kapok, are also being considered for use in seats as alternatives to polyurethane foam. As well as environmental advantages, benefits relating to comfort such as moisture absorbency are claimed. The ability of these alternative materials to dampen vibration when used in conjunction with – or in the absence of – seat springs, needs to be established. Alternative foam materials must also stand up to the continual mechanical pounding that seat components are subject to when car occupants get in and get out of the car and move about in the seat. Seat makers attempt to simulate this with the so called, 'jounce and squirm' test.

### 6.2.3.3 Sewing threads

Sewing thread, which holds all cut panels together, is an engineered material which has to withstand considerable forces both during seat cover manufacture and also during use. The actual process of sewing makes very demanding requirements on the thread, which in typical seat covers include sudden accelerations and tensions while being drawn at high speeds through not only fabric, but also light plastics. Typical sewing speeds are around 2000 stitches a minute, or 30 per second and considerable heat can be generated.

The yarn threads are spun to a high specification, resin-bonded together to prevent fraying and a carefully formulated lubricant is applied during thread manufacture which reduces needle heat and helps promote easy movement through the goods. These processes are critical to sewing performance; the thread must be round, even and balanced in twist, i.e. it must not curl around itself when allowed to hang loose. All of these properties are specified and monitored, to prevent production problems. The thread must of course last the life of the car without breaking down in any way such as snapping, shrinking or stretching. It must be very strong and have very high abrasion and UV radiation resistance in all conditions encountered in the car, including high temperatures and relative humidity. Most car seat thread is produced from continuous filament high tenacity nylon 66 in approximately 800 to 1200 dtex but varies according to specifications set by the OEM. Nylon is best suited for this application because of its abrasion resistance, elastic recovery and wet strength in addition to the ability to withstand the usual conditions inside a car. In a small number of cases, polyester thread is used; thread from this fibre is widely used in seat belts.

### 6.2.3.4 Kaptex®

Deep, well-contoured sewing lines are an aesthetic feature in their own right and can be simulated by a thermobonding technique without any actual sewing. This process, which was developed by Textile Bonding in the UK allows accurate, uniform and reproducible sewing effects and stitch patterns to be produced, in almost unlimited designs, including logos, which cannot be accomplished easily by conventional sewing.

### 6.2.3.5 Natural leather

Automotive natural leather is frequently foam-backed together with a scrim in the same way as fabric before fabricating into a seat cover. The leather is also usually lacquered with a polyurethane resin on the face side to improve abrasion resistance but this is believed to reduce breatheability. In

recent years, leather processing has undergone certain changes to comply with environmental laws.<sup>32</sup> Leather is universally regarded as the ultimate in seat luxury but is expensive and a shortage is forecast in the future both because of the increased volumes in car manufacture and also because fewer cattle are being raised for food. At the same time more and more people can afford leather and it is also being used more in design combinations with textiles. The shortage of leather together with the increased preference for leather designs is an opportunity for expansion in man-made leather products – which require textile base materials. The odour of natural leather, generally regarded as part of the overall luxurious image, is believed to be disliked, by some Japanese customers.

#### 6.2.3.6 *Man-made leather and suede*

At present the most successful man-made products, two grained leathers and eight suedes are entirely Japanese made, and the companies involved have production expansion plans. Toray anticipate a rise in the demand for man-made suede from 16 million m<sup>2</sup> in 1995 to 25 million m<sup>2</sup> by 2005 with a significant proportion going into European cars.<sup>33</sup> This estimate is already looking very conservative. The base materials are generally non-wovens using micro-fibres in polyester, which constitutes 68% of the weight, the remainder being polyurethane resin. For use as car seat covers, the man-made suede is polyurethane foam backed with a scrim fabric in the usual way. The best known is Alcantara,<sup>34</sup> made in Italy since 1975 by a Toray/Enichem joint venture (now Toray/Mitsui) and initially used mainly in Italian cars. Over a million square metres are used at present, but this is likely to increase, especially in Europe with nine car makers making use of it. A second production line for the material is being built. At present very little is used in the USA, but this is likely to change. Kuraray, one of the pioneers of man-made leather has recently entered the European automotive market with their Amaretta product.<sup>35</sup> Man-made products have the important advantages over natural leather of availability in roll form, lightness of weight, uniformity of quality, uniformity of thickness and other physical properties, which allow more efficient production planning, and minimization of waste.

Because Alcantara and other successful man-made suedes are produced by a solvent coagulation process requiring expensive plant and environmental controls, attempts have been made to develop more environmentally friendly aqueous-based methods.<sup>36</sup> One key factor in achieving the quality of man-made suede, is believed to be due to the micro-fibres in the base fabric, and the very latest products use ultra fine filaments of 0.001 to 0.003 dtex. However the polyurethane polymer must have the right properties and there is considerable skill required in the final sueding operation.

In 1994, Enichem launched a new artificial leather called Lorica,<sup>37</sup> which has several advantages over natural leather which include better elongation, tear strength, mouldability and high-frequency weldability. Lorica is made from polyamide micro-fibres and polyurethane and is available in a variety of colours.

#### 6.2.3.7 *Flocked fabrics*

Flocked fabrics at competitive prices, are claimed to reproduce the appearance and touch of velvet and suede.<sup>38–41</sup> Virtually any fibre, natural or synthetic can be flocked but materials for automotive use are mainly polyester. The manufacturing process involves applying flock by either mechanical or electrostatic means to an adhesive-coated base fabric. Flock fibre is about 0.5 to 1 mm long, about 1.5 to 3.5 dtex and can be matt, bright or semi-matt yarn in any colour. Recent improvements in flock technology have expanded the scope of flocked fabrics and Novalis Fabrics, associated with both Rhone Poulenc and Fiat, have produced material for car seat covers. They have experimental evidence showing improved seat thermal comfort of flock fabrics.<sup>38</sup> Flocked fabrics and other flocked materials (plastics can also be flocked) are finding applications in the elimination of squeaks and rattles. Flocked articles are also useful as seals for example on car windows and they can act as a lubricant for example on the sunroof sliding hatch.

#### 6.2.4 Alternative methods of seat making

Some alternative approaches to seat making replace both seat structure and foam with textile fabric. The main benefits of these methods are reduced weight, space saving by thinner profiles, reduction in the number of components and also reduced assembly costs<sup>10,42–45</sup> Recyclability and ease of disassembly are also important advantages and better thermal comfort has been claimed. One product, Sisiara (Pirelli) has been available since 1974 and has already been used in many production cars. Sisiara depends on a woven rubber/fabric supporting material, which replaces both springs and seat back and pan. The open weave allows better ventilation and the non-rigid structure allows reduced amounts of foam. The foam can be replaced altogether by Pirelli's inflatable 'Comfort Zone' system, developed in the early 1980s, and which can be adjusted to suit individual requirement by inflating the structure.<sup>46</sup> It was designed mainly for lumbar support but can also be applied to other seat areas.

A foam and spring replacing system introduced by DuPont known as Dymetrol has also been used in automotives around the world.<sup>47</sup> It is a woven fabric structure and described as being 100% polyester; the warp yarns are of DuPont's Hytrel polyester resin, the weft of regular polyester

and the whole is therefore readily recycled.<sup>30</sup> The manufacturers claim that the yarns stretch to take the exact shape of the seated person, but later return to the original dimensions, and it can do this thousands of times without fatigue. Dymetrol is woven in the USA by ACME Mills of Detroit.

DuPont have publicised the possibility of a 100% polyester seat; cover, cushion and seat frame. It would comprise a polyester face fabric, laminated to a polyester non-woven fabric, covering a squab and cushion made from DuPont polyester Fibre Cluster material. The seat frame would be made from injection-moulded Rynite thermoplastic polyester and compression-moulded DuPont XTC thermoplastic polyester. The whole assembly would therefore be constructed from all DuPont polyester materials requiring minimum disassembly for recycling and would also weigh less than a conventional seat.<sup>30</sup>

Ultra-Flex Corporation using Hoechst Celanese Elastomer monofilament fibres developed a lightweight fabric seat suspension system, space-saving and requires less foam. Better height control, less noise and greater long-term durability are also claimed. Milliken have also developed a family of fabrics known as their Gemstone range, some of which combine seat support with aesthetics.<sup>48</sup> This means that the seat is a single fabric without foam or springs underneath, saving even more weight and increasing useable space within the car. Inland Fisher Guide, now Delphi, produced an elastomeric screen-like material known as Optiride which is unique in having a dual modulus depending on the strain level. Below 30% the modulus is relatively low, but above this figure, it becomes significantly higher. Delphi has used the Optiride system with their 3-D knitted seat covers.<sup>42</sup> Very recently a further seating assembly using a warp knit fabric has appeared in the USA.<sup>49</sup>

The appearance of multipurpose vehicles (MPVs) has introduced a need for the seat layout to be flexible. Seats which can be removed and refitted by the customer must be light in weight. OEMs and seat makers have worked on this and also taken the opportunity to use new lighter-weight materials and to combine several components. Daimler-Benz have produced such a seat for their 1997 V-Class minivan which replaces 20–30 seat-back components with just a single piece in Durethan BKV from Bayer, and the whole seat is 30–50% lighter with cost savings of 10–20%. This particular seat also features a built-in seat belt. The feature of designing seats with built-in safety belts is being developed, especially for children, and some are in commercial use.<sup>50</sup>

The concept of moveable seats may lead to replacement seats, which in turn could lead to customized fabric patterns, perhaps requiring slightly less demanding performance specifications. The latter factor would allow softer cover fabric handles and a wider variety of colours. The use of composites

and carbon fibres in seat frames of high volume production cars is a development not likely to appear for several years, but the price of carbon fibres is coming down. This development would not only save weight, it would also provide more space inside the car by allowing seats with thinner profile.

### 6.2.5 Introduction to seat comfort

The car seat must be comfortable in all senses of the word; psychologically, physiologically and thermally. Researchers believe that driver discomfort is an important factor in inducing driver fatigue and so improved comfort should contribute to road safety. The seat needs to provide the body with support under all road conditions including cornering, accelerating and braking. Seat pressure distribution has been carefully studied and foams of different density are used to give support to the body in different areas of the seat. The effect of vibration on driver health and discomfort has been researched extensively,<sup>1,2</sup> and indeed there are international standards which state how much vibration the human body can withstand without ill effect, e.g. ISO 2631. Springs and foam in a car seat contribute to, and complement the vibration-damping action of the car suspension. Full foam seats used with a ‘dead pan’, i.e. with no seat springs, need to be specially developed because the foam alone must do the job of effective vibration damping.<sup>2</sup> Textile technologists who seek to replace springs and foam using non-wovens and other textile materials should be aware of all the facets of seat manufacture and design, and should work in conjunction with an OEM or seat maker from the start.

### 6.2.6 Seat thermal comfort

The thermal comfort of a modern fabric seat cover is a significant improvement compared with PVC which was widely used during the 1960s and 1970s, but in hot weather, modern car seats can still be very uncomfortably hot and sticky. A popular simple solution has been the ‘bead’ seat, which is used all over the world. There is little doubt that they are cooler, presumably because polished wooden or plastic beads are cooler to the touch in hot weather than fabric and also because they create an air gap between the skin and the car seat thus allowing some air circulation and sweat evaporation. However the bead seat is far from ideal when aesthetics and other comfort aspects are considered.

Thermal comfort has been defined, as ‘that condition of mind which expresses satisfaction with the thermal environment; the person does not know whether he or she would prefer a warmer or a cooler environment’, (ASHRAE standard 55–56).<sup>51</sup> The human body core temperature must be kept within fairly narrow limits for survival. ‘Overheating’ is prevented by

losing heat by conduction, convection, radiation and by loss of moisture which has a cooling effect due to latent heat of evaporation. A certain amount of heat is lost through the mouth by breathing – the respiratory heat loss, but this is quite small. In hot weather or during physical activity, the most important mechanism the body has for keeping cool is by exuding perspiration through the skin, i.e. sweating. This sweat must be allowed to evaporate to produce cooling. When the car interior temperature, approaches body skin temperature i.e. about 37.5°C, sweating is the only way the body can lose heat. For a person to be comfortable, this sweat must evaporate and be removed from the skin, to prevent the feeling of stickiness or dampness.

A significant proportion of the seated human body is in contact with the car seat cover, which can be regarded as another layer of clothing through which perspiration must pass. Underneath the seat cover, are the squab and cushion, made from much thicker pieces of polyurethane foam which are additional barriers to the escape of perspiration. Thin layers of foam will allow a certain amount of perspiration to pass through, but the thicker the foam, the less the ‘breathability’. Some data on the breathability or moisture vapour permeability of materials used in seat making are presented in Table 6.2, together with data on some materials known to be sufficiently breathable for comfort. Foam is also a good insulator of heat and in a normal car seat, the body will sink into the soft foam which will wrap around it, thus further reducing the ability of perspiration to evaporate. Deep sew lines in the seat cover, which can act as channels for air circulation, and as an escape route for perspiration would be expected to be beneficial to seat thermal comfort.

The issue of seat thermal comfort has been very extensively studied,<sup>52-59</sup> and several methods have been proposed to measure it.<sup>60,61</sup> Seat thermal comfort is a very subjective quality and depends on the interplay of a number of factors including the seat cover fabric itself, the laminate material in the seat cover, the squab and cushion and the seat design as a whole – not to mention the individual person’s body metabolism, fibre type in clothing and layers of clothing. There is evidence that on long journeys the material forming the back and sides of the seat also affect driver comfort.<sup>57</sup>

Polyester face fabric is not ideal for thermal comfort because of its very low moisture absorbency, but as recorded earlier, it alone satisfies the important requirements of abrasion resistance, UV degradation resistance and cost. Application of a hydrophilic finishing agent to the polyester has been shown to have some beneficial effect but finishing agents generally only have a limited life.<sup>56,57</sup> Wool or wool/polyester blends face fabrics are more costly and more moisture absorbent but will have lower abrasion resistance than 100% polyester. However some OEMs do use wool or wool

Table 6.2 Water vapour permeability (breathability) of some car seat materials

Material	Weight (g/m <sup>2</sup> )	Thickness (mm)	Porosity	Water vapour permeability (g/m <sup>2</sup> 24 h)	
				LDF (21 °C)	HDF (34.5 °C)
Seat cover material					
Polyester woven fabric	297	1.44	4.0	628	3799
Polyurethane foam	295	8.53	14.0	491	2336
Tri-laminate (includes scrim)	648	9.42	3.0	472	2256
Polyester knitted fabric					
Polyurethane foam	236	1.39	26.0	659	3788
Tri-laminate (includes scrim)	180	4.07	8.0	536	2941
	455	4.99	6.0	540	2689
Woven velvet trilaminate includes backcoating	829	10.70	3.2	388	1721
Natural leather 1					
	727	1.61	0	204	1511
Natural leather 2					
	890	1.29	0	217	834
Alcantara/scrim					
	404	1.26	1.0	596	3541
Lorica/scrim					
	510	1.30	0	526	2835
PVC 1/scrim					
	568	0.92	0	15	416
PVC 2/scrim					
	818	1.58	0	30	168
Other seat materials					
Seat squab foam	1200	20.00	13.5	294	1168
Seat cushion foam	1050	15.00	14.0	352	1458
Rubberized 'horse hair'	606	2.00	Infinity	703	1779
Polyester needle- punched non-woven	405	5.38	50+	556	2881
Kunit	422	12.40	22.00	627	2807
Spacer fabric	240	3.60	50+	601	3377
Adhesive films					
Polyurethane adhesive film	42	0.10	0	68	263
Polyurethane adhesive film after lamination	—	—	—	260	1673
Polyurethane adhesive film with holes	31	0.22	—	351	1124
Polyolefin adhesive film	42	0.10	0	68	263
'Breathable' films					
Gortex Clothing Triple Laminate (WL Gore)	172	0.40	0	423	2862
Sympatex Clothing Double Laminate (AKZO)	137	0.31	0	532	3343
Porelle Film Only (Porvair)	28.4	0.11	0	576	3196
Scotch Microporous Polypropylene Film (3M)	29.4	0.11	0	576	3196

Test methods

ASTM E-96 80 (evaporative method) with an airgap of 2.0cm.

LDF = low driving force, 21°C ambient, 21°C inside test vessel.

HDF = high driving force, 21°C ambient, 34.5°C inside test vessel.

Porosity (air permeability) BS 4442 Pt 6 Method 16.

Source: Reference 57 and BRITE EURAM PROJECT 5549.

blends in seat cover laminates both in face fabric and also in the backing to reduce the stickiness feeling.

Any barrier to air and moisture permeability is therefore very likely to reduce seat thermal comfort, and care must be exercised when adhesive films or barrier films for vacuum forming techniques are used in seat construction. Any measurements of breathability must be compared with realistic standards, e.g. Goretex (WL Gore), Sympatex (AKZO) or Porelle (Porvair) membranes, which have proven performance properties in protective clothing, see Table 6.2. Measurement of breathability is a complex subject because test results are very dependent on the test method, as anyone in the protective-clothing industry knows well. In recent years several other apparently suitable products have been introduced, for example films by Wolff Walsrode (Bayer) and by 3M. Driving a car is not a high energy activity, in fact some researchers have shown it is comparable with sleeping and walking slowly along a flat road.<sup>62</sup> However, temperatures inside a car in sunny weather, with the occupants inside, can easily exceed, say, 30°C and even at this temperature the amount of perspiration exuded by an average person at rest can be equivalent to the amount exuded in high-activity situations at normal ambient temperatures.

Several attempts have been made to achieve enhanced thermal comfort by use of carefully chosen assemblies of fibres to first absorb moisture, then to transport it away from the skin.<sup>63</sup> In one novel development a natural fibre Ramie, is used as a moisture transport medium.<sup>64</sup> Other methods to improve seat thermal comfort have been made by the use of ventilated seats using air driven by electric fans. This has been used in commercial vehicles, lorries and buses, but in early 1998, Saab featured this luxury item in their 9–5 saloon car in the USA – the first for a volume production car. The problem of seat thermal discomfort should be significantly alleviated by air conditioning in volume production cars. Installation of air conditioning in new American cars has been increasing and reached over 90% by the 1990s. In Europe, Installation of air conditioning in vehicles has also been growing steadily from about 12% in 1990 to 56% in 1998 and is expected to reach 70% by 2000.<sup>65</sup> This luxury item, now becoming regarded as standard, is typical of how quality is being raised by the OEMs and how the general consumers' expectations and demands are increasing. Air conditioning units however add to cost, weight and fuel consumption.

### 6.2.7 Seat comfort – the complete picture

Comfort is a neutral condition and garment comfort researchers regard garments as comfortable when the wearer is physically unaware of them. Researchers conduct their studies by measuring *discomfort*. In a similar

manner to the clothing situation, seat comfort is influenced strongly by fabric properties, but it is dependent on a very large number of interrelating factors which merge to provide an overall largely subjective assessment of comfort in the car.<sup>66</sup> There are, however, established measurable scientific data relating to comfort such as the vibration frequencies at which the human body is known to be sensitive and levels of noise at which health begins to suffer. However many quantities are highly subjective, depending on the individual's personal preference and culture, past experience, level of tolerance, metabolism and state of health. National preferences for comfort factors are known to exist, for example the hardness of cushion foams can vary by more than 50% when measured by compression stress/strain. Textiles play a significant role in improving comfort in other ways, not only by vibration and sound damping in interior trim components including the carpet and headliner, but also by noise insulation under the bonnet and under wheel arches. Textiles allow the production of overall mentally relaxing interiors by fabric design and colour.

Psychological comfort includes the following quantities: overall aesthetic appearance; fabric construction/yarn type; design/colour; seat contours; current fashion; prejudice; and suitability for vehicle.

Physiological comfort or sensorial – next to the skin sensation is influenced by: softness; abrasion – roughness; smoothness; initial cold/warm feel; not too slippery; fibre shedding; prickle/tickle; and allergy.

Other relevant factors include: seat support/pressure distribution/seat geometry; suspension factors/vibration/smoothness of ride; wind/tyre/engine noise/squeaks/rattles/other noise; ventilation/air flow; interior temperature/humidity; availability, positioning of controls; ease of getting in and out of the vehicle; and visibility out of the car in all weathers.

The OEMs, universities and associated research institutions are carrying out considerable research on all aspects of car interior comfort. Entering and getting out of the car, especially by the elderly and disabled are problems to be overcome. Regular conferences and symposia such as those hosted by the Italian Associazione Tecnica Dell' Automobile in Bologna, are held to present and to discuss the latest findings. The ergonomics of seat design such as, suitability for drivers of different shapes and sizes, ease of reaching controls, visibility, getting into and out of the car etc., have also been studied intensively.<sup>67,68</sup> Textiles are eminently suitable for sound and vibration insulation and damping and also for eliminating squeaks and rattles. Seat discomfort contributes to driver fatigue, a recognized cause of accidents and as such is taken very seriously by the OEMs and seat makers. Recent research efforts are being directed towards improving the comfort and thermal comfort of seats for very young children and babies.

## 6.3 Headliners

At one time the headliner was simply a covering for the metal roof inside the car and consisted of a piece of fabric, PVC or some other material sometimes simply 'slung', i.e. held in place only at a few points. It has developed over the last 20 years into a sophisticated module component, important for sound and vibration insulation, as well as contributing to the overall interior appearance and actual structure of the car. There are also the usual performance requirements of interior trim although not quite as rigorous as seating material. Headliners now incorporate items such as driving mirrors, interior lights with wiring, assist handles, sunvisors, sunroofs and even brake lights in some models.<sup>69</sup> Other important requirements are lightweight, thin profile but rigid without any tendency to buckle, flex or vibrate, dimensional stability, aesthetically pleasing and preferably with a soft touch. A recent report noted that headliners seem to be touched more often, and this may lead to anti-soiling requirements. Future headliners are also likely to incorporate safety devices especially in the USA as FMVSS 201, the safety requirement for head protection is phased in. Certain interior designers have suggested that because instrument panels are becoming so overloaded with controls, some items should be relocated to the relatively vacant space in the headliner, although other designers disagree because of safety considerations.<sup>70</sup> If controls do appear on the headliner, anti-soiling is likely to become a requirement.

### 6.3.1 Headliner structure

The modern headliner is a multiple laminate of up to seven or more components all joined together, see Figs 6.4 and 6.5. Each layer is there for a specific purpose either for aesthetics, to provide sound insulation, vibration damping or to provide rigidity to the whole structure. Research work has been carried out to optimize the sound and vibration damping.<sup>71-73</sup> The centre core is generally a layer of semi-rigid thermomouldable polyurethane foam, initially about 15–30mm thick or alternatively composed of waste fibre (recycled garments) bound with semi-cured phenolic resins. The centre core of polyurethane is bonded to two layers of chopped fibreglass rovings, one on each side. The fibreglass rovings are bound together and embedded in thermoplastic material, i.e. hot-melt adhesive powder or hot-melt adhesive film, e.g. Xiro film, or a combination of both.<sup>74</sup> These materials also act as the adhesive when the layers are joined together. Opinion differs whether continuous or slit film adhesives contribute the most to noise reduction. The layers of glass-roving help impart rigidity to the structure and are not always necessary when phenolic-resinated waste



6.4 Automotive headliner covered with nonwoven fabric. Courtesy of Cosmopolitan Textile Company Ltd.

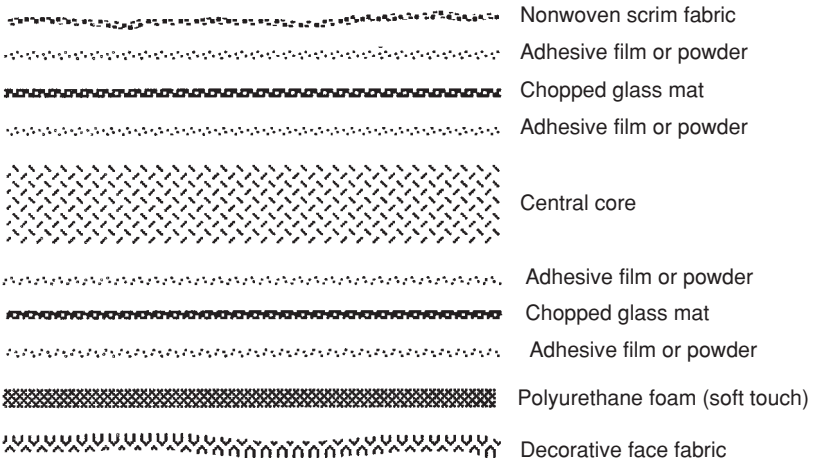

6.5 Typical multilayer headliner construction. The central core is semi-rigid polyurethane foam, resinated shoddy waste fibres or some other material. Heat is applied to the assembly in a flat-bed laminator to join all the components together. The material is then cut into lengths, heat is applied and the headliner is press-moulded to the required shape. During the latter process the assembly is compressed to about one-third of its original thickness. The adhesive film or powder permeates through the chopped glass mat and consolidates it. The chopped glass mat contributes to rigidity and acoustic insulation.

fibres are used. Attached to the side facing inwards is the decorative material, a non-woven polyester scrim is usually attached to the other side. All layers are joined together by action of the hot-melt adhesives in a flat-bed laminator, taking care not to damage the aesthetics of the decorative material nor to reduce the thickness of the centre core. The correct temperature and pressure must be optimized.

The composite sheet is then moulded to produce the required shape. The usual procedure is to preheat the assembly with infra-red heaters just before placing it into an unheated mould where pressure is applied. During this moulding operation the semi-cured phenolic resins are fully cured and the thickness of the central core is reduced to about one-third of its original thickness. All of the hot-melt adhesives have to be selected to meet the heat resistance specifications. A corrugated cardboard material, used as the central core in some models is relatively inexpensive, and can be recycled. However corrugated cardboard does not always allow sharp well-defined lines when moulded. Phenol-resinated cotton is relatively low cost, has good formability and acoustic properties but is heavy and if damp, can distort and give off odours.

Another well-known method of bonding the structure together, the Tramivex method,<sup>72</sup> involves dipping the polyurethane foam into a bath of liquid chemicals, while in other cases spray adhesives are used. The patented 'high calorific transfer medium' (HCTM) process, which makes use of superheated steam to activate hot-melt adhesives, is used for headliner construction as well as for door casing and seat making. Headliners are sometimes bonded to the car roof to become a part of the car structure, helping to eliminate roof bows, but other opinion believes this procedure increases noise. Fibreglass is not strong enough to be bonded directly to the roof and so a layer of a corrugated cardboard-type material is used in between the roof and the fibreglass. Headliners in larger vehicles generally have more layers to ensure rigidity and they may also be thicker in luxury cars for more effective sound proofing.

In the USA alternatives to fibreglass are being explored, because of dermatitis complaints by workers, who handle the fibreglass.<sup>75</sup> In addition, because headliners have become more complex and incorporate more items, the fibreglass is more easily damaged during the assembly process; phenolic-resinated fibreglass is especially brittle. Fibreglass began to be used because of its exceptional properties in sound absorption. Non-woven researches are attempting to replace fibreglass and the centre semi-rigid polyurethane, with polyester non-woven, to achieve a 100% polyester article, which should be more easy to recycle. Another material being considered is natural fibre-reinforced urethane (NFRU) which is energy absorbing and may contribute to meeting the safety requirement, FMVSS 201 for head protection.

In the USA knitted headliners are losing ground to non-wovens which are used extensively in Europe and Japan.<sup>76–78</sup> Non-woven cover fabrics have the advantages over knitted fabrics of less cost and fewer in-moulding operations, they do not try to shrink back, but stay in place allowing deeper draws. The latest developments in headliner non-wovens include the use of fine denier polyesters, 3–6 denier per filament (dpf), which have good covering ability at low weight. Polyester fibre has a higher melting point than polypropylene, which means that in thermal moulding operations, a higher temperature with shorter processing times can be used. Typical non-woven headliners are about 200–220 g/m<sup>2</sup>.

In the USA, FMVSS 201 requires that by 1999, 10% of all new vehicles must have some safety feature for head protection, by 2000 this will increase to 25%, by 2001 to 40% and by 2002 to 70%, increasing further to reach 100% by the year 2003. This could be satisfied by some type of airbag, or possibly even by a layer of foam up to an inch thick, although the latter option may lack available space.<sup>79</sup>

## 6.4 Door casings

Face fabrics for door casings are generally similar to seating fabrics and in many cases the same material is used for both applications in the same car. The textile/polyurethane foam laminate (there is generally no need for a scrim), is almost invariably used on a door casing in combination with a foil or film made from polyolefin (known as TPO – thermoplastic polyolefin), polyurethane, PVC, or PVC/ABS to produce a two-tone or two-design effect. Wood, wood-veneer or a natural or synthetic leather are also used. In some car models the textile is just a small insert panel or ‘window’. Closed cell polypropylene foam, such as Alveo (Sekisui) has appeared in some models in place of polyurethane foam to provide a slightly firmer soft touch to the cover stock, which is preferred in some up-market models. At the bottom of many car doors is a piece of non-woven covering material, usually a needle-punched polyester or polypropylene felt, the so-called ‘kick panel’.

As with seat making, the process of door making was labour intensive with even simple operations such as turning down edges of covering fabric or foil presenting manufacturing problems. A variety of different manufacturing methods using several different polymers, see Table 1.5, are now being used in continuing efforts to reduce costs by integrating various individual steps into fewer operations and also to achieve the more complex shapes now required by the designers.<sup>80–87</sup> Textile-insert low-pressure moulding techniques, for example using polypropylene resin, can produce a covered door panel in a single operation, see Fig. 6.6. No lamination process and no adhesive is necessary but barrier materials are sometimes

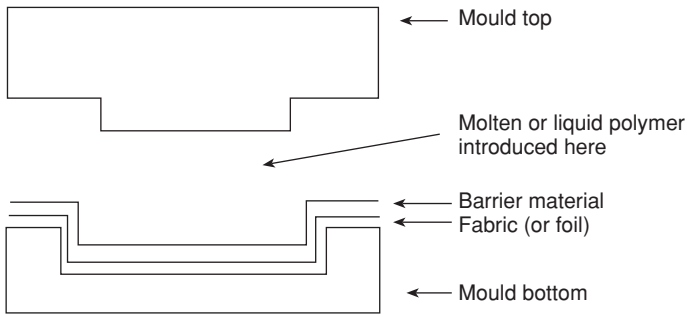

- 6.6 Component manufacture by 'one shot' textile (or decorative film) insert moulding. The process involves introduction of the polymer, either in molten or liquid form into the space between the top and bottom mould and over the fabric and barrier material. This is carried out by injection through an orifice in the top mould or by some other means. For long components, more than one orifice or gate may be needed. Skill and technical knowledge are required to obtain consistently satisfactory results. Care is needed to prevent damage to the face fabric; polyester begins to soften below 100°C, well below its melting point. Application of pressure increases the risk of damage to fabric texture or pile. The barrier material is to prevent the liquid or molten polymer penetrating through to the face fabric before it solidifies to become the rigid carrier component. This general principle is used to make door casings, A, B and C pillars, parcel shelves. This single process, combines the following: 1. Fabrication of the rigid carrier. 2. Thermoforming the component to shape. 3. Lamination of the face fabric (or foil) to the rigid carrier.

required on the back of cover laminates to prevent the molten resin from penetrating to the face of the fabric. In some operations, the armrest is produced as an integral part of the textile-covered door panel in a single moulding operation combining what used to be several individual steps, see Figs. 6.7 and 6.8. The thickness of the cover laminate, i.e. the thickness of the polyurethane foam, is critical in some operations.

Textile/polyurethane foam-cover laminates joined to a material produced from wood chips and polypropylene is widely used to make door panels, but more process steps are required and this method is slowly losing ground to the single operation techniques. In the former method spray adhesives are used in some cases. Textile 'window' insets on door casings are sometimes produced using pressure-sensitive adhesive-backed (PSAB) components. Welding methods are also sometimes used in place of adhesives but the materials to be joined must be thermoplastic and capable of forming a good non-brittle join.



6.7 Integral door panel and arm rest.

The use of natural materials is being examined and in fact is being used in some cars in efforts to make the car 'greener' in response to pressure groups and governments. An example is Mercedes' use of natural fibres in a polyurethane matrix for the rigid door panel. There are also benefits to be gained since some natural materials have mechanical properties, which allow weight savings when used in composites.

Modern door casing manufacturing techniques, and the newer curvaceous designs are necessitating additional quality control tests to check suitability. Integral armrests produced by a single operation, may require fabric stretchability of up to 30% or more for deep drawer mouldings, see Fig 6.7. It is necessary to achieve well-defined contours, without pile distortion or crushing during moulding. The fabric laminate/door casing bond must withstand environmental tests and many years' use in the car without the textile lifting or delaminating over the sharp concave curves.

The Tier-1 companies continue to examine car door construction very thoroughly with the objective of integrating as many steps as possible in order to further reduce costs. Safety aspects have assumed more prominence recently, and side-impact protection units, designed to absorb and direct impact energy away from passengers, need to be incorporated into the door structure without reducing interior passenger space. In the USA side-impact protection for cars and light trucks is a legal requirement, FMVSS 214.

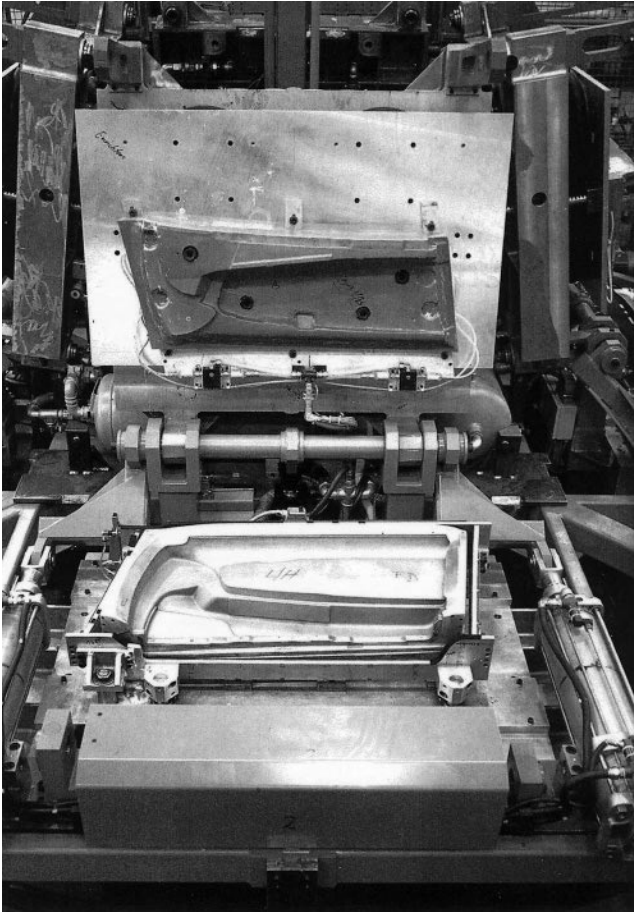

6.8 Door panel moulding. Reproduced by kind permission of Paul KIEFEL GmbH.

## 6.5 Parcel shelves

Parcel shelves, also referred to as package trays or the 'hat rack' are now almost invariably covered with needle-punched non-wovens mainly in polypropylene or polyester. At present, in Western Europe about 60% is polyester, the rest is in polypropylene. In Japan the usage is virtually all polyester; in the USA, it is virtually all polypropylene, but polyester is used in Japanese transplants in the USA. Parcel shelves range in size from relatively narrow components in saloon cars, to a much larger and wider article in hatchbacks. The textile-insertion low-pressure moulding method is sometimes used with a polypropylene covering to produce an all-polypropylene component. Polypropylene needle-punched fabrics used, are typically of

210 g/m<sup>2</sup> weight for flat components, ranging up to 298 g/m<sup>2</sup> for more curvaceous designs which require deep draw moulding. At present, however, the more traditional method of laminating the cover fabric to a rigid component made from shoddy (waste fibres) or wood fibre is still widely used.

Both the parcel shelf and the dashboard are directly under the large sloping glass windows of the car and their UV, lightfastness degradation and thermal resistance against delamination and distortion requirements are amongst the highest in the car interior. The face fabric must have reasonable abrasion resistance and the component as a whole must have sound absorption properties. Both polyester and polypropylene fibres are used and which is to be preferred is a matter of opinion and equipment available. Some producers report that higher production rates are possible with polyester because it can withstand higher temperatures and therefore shorter processing times. Others prefer polypropylene, because it is lighter, requires lower production temperatures and is easier to recycle.

The continued development of injection moulding techniques will lead to further test methods and standards for resin penetration through the textile cover. Other interior trim components are already made by textile insert injection moulding methods, i.e. A and B pillars. Back injection techniques when used for larger items, may need multiple gate equipment.<sup>87</sup> As molten polymer is being injected, cooling is occurring all the time and the sideways flow possible from a single nozzle or gate is limited. Thus two or more gates may be required but the point at which the molten polymer from different gates merges is a potential area of weakness and these operations must be skilfully designed and carried out.

## 6.6 Other interior trim

### 6.6.1 Dashboard

The dashboard, probably the hottest area in the car interior, offers some opportunity for textiles, although only a very limited number of car models use fabric at present in this very demanding application. Some Italian cars make use of textile inserts with the usual plastic foil as the main covering material. The dashboard shape being highly curved and also complex, to accommodate controls and instruments, presents many problems for the textile technologist. It could probably only be obtained by knitting, and 3-D knitting would be eminently suitable. Performance requirements of the dashboard are amongst the highest within the car interior but textiles could be made to fulfil the necessary criteria, i.e. low gloss (no glare or reflections on the windscreen), soft touch, pleasant aesthetics, non-fogging, non-odorous, UV stability, resistance to heat ageing, resistance to low temperature and high abrasion resistance. Cleanability would be limited but the

ability to be thermoformed in mass production would be the most difficult problem to overcome.

### 6.6.2 Sunvisors

In the USA, sunvisors are produced from raised-warp knit fabric, whereas in Europe PVC is still extensively used. Some sunvisors are produced by injection moulding, others are composed of metal frames and rigid foam or cardboard are also used. The article is close to the windscreen and UV, light and heat resistance must be of the highest standard. Passenger safety is also an important consideration. There are opportunities for textiles, especially non-wovens in this area to produce a recyclable product.

### 6.6.3 Boot or trunk linings

With the advent of hatchbacks and split rear seats, the boot has become an extension of the car interior requiring better quality décor than before. About 4m<sup>2</sup> of fabric are needed for this area and needle-punched polyester or polypropylene are the main covering materials. The boot also requires noise insulation and a variety of materials are used for this purpose including natural fibres such as hemp and sisal and also shoddy waste fibre. The main requirements are low cost, light weight and mouldability, achieved by resination. Up-market cars are likely to have thicker linings for extra noise insulation and some cars have interior wheel-arch liners.

### 6.6.4 Further new materials

DuPont Thermolite acoustic insulation, a matting of 100% DuPont Dacron polyester has been developed to reduce noise in the passenger compartment. It is an alternative to fibreglass and polyurethane foam but has the advantages of light weight, cost effectiveness, easier and cleaner installation and recycleability. It could be used in the headliner or in door panels of luxury cars. Thinsulate brand acoustic insulation made by the 3M company has the novel properties of high acoustic absorbency performance at exceptionally light weight and reduced bulk, see Fig. 6.9.

Recycled polyester non-woven fabric produced from bottles is already used under the dashboard in some high volume Japanese cars. Very recently it was announced that Visteon and Kafus are to produce interior components from composites made from kenaf and other natural fibres.<sup>88</sup>

### 6.6.5 Ancillary textile items

Textiles are also present inside the car in a variety of ancillary products such as luggage netting on the backs of seats and luggage restraints or coverings

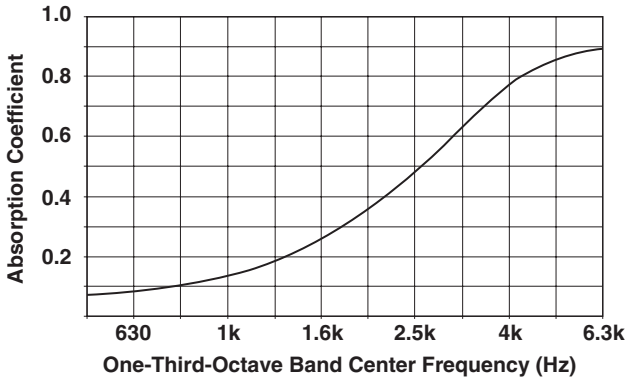

6.9 Sound Absorbing Properties of Thinsulate™ Acoustic Insulation. Sound Absorbing properties of Thinsulate™ Acoustical Insulation material AU1220, measured according to ASTM E1050, Dual Microphone Impedance Tube Method measuring Normal Incidence Sound. Thinsulate™ acoustic insulation provides especially good results at the high frequencies which are particularly unpleasant to the human ear. Diagram produced by 3M Company and reproduced with kind permission of 3M Deutschland GmbH.

in estate cars. Fibre flock has already been mentioned. Knitted fabric is used as bellows for handbrakes and gear levers. In far-Eastern countries curtains and loose covers are seen in many cars.

## 6.7 Complete modular interiors

The process of combining individual operations in the outsourced production of interior components is being progressed yet a stage further.<sup>89–93</sup> The car interior will eventually be made up from a small number of complete modules, i.e. the seat module, the headliner module etc. and the ultimate is the *entire car interior* being integrated into one combined operation by a single supplier to the OEM. The Lear Corporation have already declared that this is desirable – a whole car interior will be put together at a single negotiated price. The advantages of this operation are that very many separate steps can be combined together simplifying manufacturing procedures, reducing the number of components, reducing interfaces, reducing administration and overheads and producing significant overall cost savings. As this happens it is inevitable that the responsibility for design will shift towards the Tier-1 module suppliers and to a certain extent away from the OEMs. Certain Tier-1s are becoming very large and influential entities in the auto industry and some analysts have referred to this as the emergence of the ‘Tier-0.5 suppliers’.

## 6.8 References

1. Griffin MJ, *Handbook of Human Vibration*, London, Academic Press, 1990, 404–8.
2. Crocco GL & Kinkelaar MR, (ARCO-now Lyondell), 'Improving the driving comfort of automotive seating', Autotech, NEC Birmingham, 4–6 November 1997, and with Neal BL, 'The influence of polyurethane foam dynamics on the vibration isolation character of full foam seating', *SAE International Congress and Exposition*, Detroit, 23–6 February 1998.
3. Bellina G (Sepi, now Lear), 'Evolution of the car seat as a system', ATA Conference, *New design frontiers for more efficient, reliable and ecological vehicles*, Florence 1994.
4. Eller R, 'Molding the future interior', *Automotive & Transportation Interiors*, September 1996, 24–31.
5. Kussmann LW, 'Upholstery materials; short design to series production lead times', *Textiles and surfacing materials* (with *Plastics in automotive engineering*), VDI Congress, 25–6 March 1998, Mannheim, VDI, Dusseldorf, 1998.
6. Grant P, 'Textile laminates for the foam in fabric process', *Urethanes '90*, Plastics and Rubber Institute Conference, Blackpool, 16–17 October 1990.
7. ICI Polyurethanes Newsletter, Vol 4, Number 6, 1990.
8. Koepfel RC, 'Developments in lamination and laminates in foam in place seating', *Textiles in Automotives* Conference, Greenville, NC, 29 October 1991.
9. HCTM Process, Astechologies Technical Information Leaflet. Roswell, Georgia 1997.
10. Braunstein J, 'Whole lot goin' on underneath', *Automotive & Transportation Interiors*, April 1997, 22–32.
11. Anon, Seat systems, *Automotive Engineering*, May 1994, 25–35.
12. Anon, 'Knitted car upholstery', *Knitting International*, June 1993, 100 (1194), 34.
13. Robinson F & Ashton S, 'Knitting in the third dimension', *Textile Horizons*, December 1994, 22–4.
14. Robinson F & Day GF, 'Knitted fabric', US Patent 5027618, 7 February 1991.
15. Day GF, Lay TM & Leeke GJ, 'Upholstery fabric incorporating chenille on one face', US Patent No. 5428969, 7 April 1995.
16. Gardner C, 'CAD and CAE, balancing new technology with traditional design', *Inside Automotives International*, June 1994, 17–20.
17. Smith TL, '3-D knitting adds new dimension to interiors', *Automotive & Transportation Interiors*, November 1994, 42–5.
18. Anon, 'Technical Textiles', *Knitting International*, June 1996, 103 (1227), 38–9.
19. Jones M & Girard W, '3-D knitting', *Automotive Interiors International*, Autumn 1995, 24–30.
20. Schmidt G & Bottcher P, 'Laminating nonwoven fabrics made from or containing secondary or recycled fibres for use in automotive manufacture', *Index Conference 1993*. Session 3A, Geneva, Brussels, EDANA.
21. Fuchs H & Bottcher P, 'Textile waste materials in motor cars – potential and limitations', *Textil Praxis International*, April 1994, (4), II–IV.
22. Hirschek H, 'Recycling of automotive textiles', *IMMFC*, Dornbirn, 22–4 September 1993.
23. Ostes M (Rhone-Poulenc), 'Use of textiles in vehicles and recycling; state of the art and outlook', *IMMFC*, Dornbirn, 22–4 September 1993.

24. Kiefer B, Bornhoff A, Ehrlern P, Kingenberger H & Schreiber H, 'Assessing second hand automotive textiles for use in new vehicles', *IMMFC*, Dornbirn, 20–2 September 1995.
25. Karl Meyer/Malimo TI leaflet, 'Manufacture of fabrics for automotive interiors using warp knitting and stitch bonding' *We* 75/1/8/93.
26. Schmidt GF, 'Replacing foam by using the 'Kalitherm' technology and flameless laminating', *IMMFC*, Dornbirn, 15–17 September 1999.
27. Crema R, Jirsak O, Hanus J & Saunders T, 'Whats new in high loft production', *International Nonwovens*, Oct 1997, and also Georgia Textile Machinery Inc., website address <http://www.struto.com/technical.htm>
28. Fung W, 'Technical requirements of automotive applications of nonwoven materials as textile or substitutes for other materials', *Index Congress*, Geneva, 27–30 April 1999, Brussels, EDANA.
29. Hartwig P, 'Nonwoven and PUR foam-competition or complement', *Index Congress*, Geneva, 27–30 April 1999, Brussels, EDANA.
30. Gardner C, 'Interiors industry's one stop shop – DuPont Automotive', *Inside Automotives International*, March/April 1995, 40–5.
31. Tanka H (Toyobo), 'Highly functional cushion material, BREATH AIR', *IMMFC*, Dornbirn, 17–19 September 1997.
32. Muirehead JAM, 'Automotive leather and the environment', *Inter Auto 98*, Amsterdam, 13–15 October 1998.
33. Anon, 'Man-made leather grows in product and demand', *JTN*, June 1997, 66–73.
34. Borri C, 'Comfort for car interiors – Alcantara – features and advantages of a unique product', *IMMFC*, Dornbirn, 22–4 September 1993.
35. Tanaka N & Tanaka J, (Kuraray), 'New man-made leather for automobiles', *IMMFC*, Dornbirn, 15–17 September 1999.
36. Hemmrich J, Fikkert J & van der Berg M, (Stahl), 'Porous structured forms resulting from aggregate modification in polyurethane dispersions by means of isothermal foam coagulation', *J Coated Fabrics*, April 1993, 268–78.
37. Bagnoli G & Polette G, 'The revolutionary high-tech leather, Lorica for automotive interiors', *IMMFC*, Dornbirn, 22–4 September 1993.
38. Bianchi JP, 'Flock technology for car interiors for automotive textiles' *IMMFC*, Dornbirn, 17–19 September 1997.
39. Bolgen SW, 'Flocking technology', *J Coated Fabrics*, 21 October 1991, 123–31.
40. Smith TL, 'New technologies expand applications for flocked materials', *Automotive & Transportation Interiors*, October 1995, 38–9.
41. Maag U, 'Flock-textile coating, a solution for many technical problems', *IMMFC*, Dornbirn, 15–17 September 1999.
42. Borroff R, 'Rubber soul', *Automotive Seating Review*, 1997, 22–6.
43. Anon, 'Seat systems', *Automotive Engineering*, May 1994, 25–35.
44. Lloyd R, 'Automotive seating into the 21st century' *Automotive Interiors International*, Winter 1993, 42–7.
45. Anon, 'Materials spotlight', *Inside Automotives International*, August 1998, 43–4.
46. Pirelli Technical Information, 'Thinline Seating'.
47. Gretzinger J, 'Dymetrol seating supports for automotive applications', *Automotive Textiles Symposium*, Greenville, S Carolina, Oct 1991. Also US Patent No. 4469739 (Gretzinger J & Rackley RL).
48. Lebovitz R, 'Elastomeric fabrics may redefine auto seating', *Automotive & Transportation Interiors*, March 1996, 19.

49. McClintock B, *et al*, 'Knitted automotive seating fabric' US patent No. 5 457 968, *America's Sportswear and Knitting Times*, October 1997, 8–9.
50. Thomson J, 'Restraining orders', *Inside Automotives International*, August 1998, 18–22.
51. Fanger PO, 'Conditions for thermal comfort – a review', *Building Establishment Report 2*, HMSO, 1973.
52. Bollinger H & Duwel KR, 'New concepts in seating', *Textiles in Automotives*, VDI Congress, Dusseldorf, 30–1 October 1991.
53. Knozinger GT, Theysohn H & Vogt H, 'Physiology of seat comfort', *Textiles in Automotives*, VDI Congress, Dusseldorf, 30–1 October 1991.
54. Jarrigeon M, 'Sensorial and thermal comfort' *Tehtextil*, Frankfurt, 1991.
55. Temming J, (VW), 'Assessment of the suitability for summer weather of vehicle seats', Speciality Conference, 22–3 September 1992.
56. Fung W & Parsons KC, 'Some investigations into the relationship between car seat cover materials and thermal comfort using human subjects', *J Coated Fabrics*, 26 October 1996, 147–76.
57. Fung W, 'How to improve comfort of the car seat', *J Coated Fabrics*, 27 October 1997, 126–45.
58. Umbach KH, 'Parameters for the physiological comfort of car seats', *IMMFC*, Dornbirn, 15–17 September 1999.
59. Bartels VT & Umbach KH, 'Laboratory tests of thermophysiological seat comfort', *Comfort in the Automotive Industries*, ATA Symposium, Bologna, 6–7 November 1997.
60. Anon (input from GM, Ford & VW), 'Measuring seat comfort', *Automotive Engineering*, July 1993, 25–30.
61. Hanel SE, Dartman T & Shishoo R, 'A method for measuring mechanical and physiological comfort in car seats', *IMMFC*, Dornbirn, 20–2 September 1995.
62. Astrand P-O & Rodahl K, 'Textbook of Work Physiology', 3rd edn, New York, McGraw Hill, 1987, 505.
63. Lohmann P, Eckel E, Pelz B & Potzler I, 'Textile fabric for seat covers or cushions, in particular for seats in motor vehicles', International Patent Classification; B32B; US Patent No. 5 747 393, Publication date 5 May 1998.
64. Kalin A, (Rohner Textil), 'Textile substitute for seat covers', US Patent No. 5 617 904, 8 April 1997.
65. Wagstaff I, 'The white heat of air conditioning technology', *Automotive Sourcing*, V issue V, 1998, 194–202.
66. Smith J, 'The comfort of clothing', *Textiles*, 15 (1) 23–7.
67. Griffin M, 'The ergonomics of vehicle comfort', *Vehicle Comfort and Ergonomics*, 3rd International Conference ATA, Bologna, 29–31 March 1995.
68. Porter M, 'Seating design – current problems and future strategies', *Automotive Interiors International*, Autumn 1994, 6–19.
69. Creasy L, 'Look out overhead', *Automotive & Transportation Interiors*, December 1997, 28–33.
70. Borroff R, 'Skys the limit', *Auto Interiors International*, Summer 1999, 36–8.
71. Pikula D, Koesis MJ & Brandon RH, (Dow), 'Acoustic evaluation of automotive headliner composites with various adhesive systems', *Automotive Textiles* PT-51 SAE (ed. M. Ravnitsky) Warrendale, PA, SAE, 1995, 173–83.

72. Souders SL, Doerer RP & Scott TE, 'Engineering optimisation and tuning of vehicle interiors sound insulation', *Automotive Textiles* PT 51, SAE (ed. M. Ravnitsky) Warrendale, PA, USA, SAE, 1995, 185–203.
73. Westrick RW & Grey JW, 'What's new in automotive headliners', *Automotive Textiles* PT-51 SAE (ed. M. Ravnitsky) Warrendale PA, SAE, 1995, 123–6.
74. Fichtenthal NH, 'Meeting tomorrow's economic and environmental requirements', *Progress in Textile Coating and Laminating*, BTTG symposium, 2–3 July, 1990, Chester.
75. Pfortner P (Freudenberg), 'Nonwoven applications for automotive interiors today and tomorrow' *Inter Auto*, Amsterdam, 13–14 October 1998, organised by Inside Automotives International, Michigan.
76. Daniels J, 'Nonwoven headliners – a European perspective', *Inside Automotives International*, January/February 1995.
77. Gardner C, 'Headliners, rising to the occasion', *Inside Automotives International*, December 1994, 19–23.
78. Lebovitz R, 'Nonwovens offer new interior possibilities', *Automotive & Transportation Interiors*, September 1997, 18–19.
79. Anon, 'New head impact rules spur research', *Automotive & Transportation Interiors*, April 1996, 28–9.
80. Gabriel MC, 'Composites carve niches in interior thermoforming', *MPI*, October 1997, 56–61.
81. Anon, 'Fully upholstered components straight from the mould', *BPR*, March 1992.
82. Anon, 'Textile insert moulding', *BPR*, August 1992, 12–14.
83. Murphy J, 'Opening up – door design', *Automotive Interiors International*, October 1998, 34–8.
84. Moran T, 'Carpeted parts hot off the press', *Automotive & Transport Interiors*, September 1998, 36–8.
85. Rhone-Poulenc Setila/Mavel, Automotive newsletter, April 1997, 4.
86. Rudiger von Barisani K, (Eybl-Durmont), 'New technology for the production of car interiors', TI leaflet.
87. Beckmann F, Kosel H, Mischke J and Pasch M, 'Fabric back injection from special processes to mass production' VDI Conference, *Textiles and Surfacing Materials (Plastics in Automotive Engineering)*, Mannheim, 25–6 March 1998, VDI Dusseldorf 1998.
88. Anon, 'Natural fibre deal', *FT Automotive Components Analyst*, February 1999, 19.
89. Sullivan LE, 'System integration; the race is on', *Automotive & Transportation Interiors*, June 1997, 20–3.
90. De Witt J, 'Modular manufacturing points way to systems integration', *Automotive & Transportation Interiors*, February 1996, 38–40.
91. Sullivan LE, 'Systems integration; automakers break old habits', *Automotive & Transportation Interiors*, April 1997, 32–6.
92. Daniels J, 'The car interior; ever modular?', *FT Automotive Components Analyst*, February 1999, 16–18.
93. Markel AJ, 'Getting it together', *Inside Automotives International*, August 1998, 12–15.

## 6.9 Further reading

1. Bedford AM & Wilshaw TR, 'Development of high strength substrate for use in modular headliner systems', *SAE Technical Paper Series*, Warrendale PA, USA, SAE International, 1991.
2. Boswell B, 'The right thread for the job' (sewing threads), *Automotive & Transportation Interiors*, June 1999, 66–8.
3. *Comfort in the Automotive Industry*, Technical Papers of 3rd Conference, 29–31 March 1995, ATA/Bologna University.
4. *Comfort in the Automotive Industry*, Technical Papers of 4th Conference, 6–7 October 1997, ATA/Bologna University.
5. Fourt L & Hollies NRS, '*Clothing, Comfort and Function*', New York, Marcel Dekker, 1970.
6. M<sup>c</sup>Crum NG, Buckley CP & Bucknall CB, '*Principles of Polymer Engineering*', Oxford, Oxford University Press, 1997.
7. *Modern Plastics Encyclopedia Handbook*, edited by Modern Plastics Magazine, New York, McGraw-Hill, 1994.
8. Mukhopadhyay SK & Partridge JF, '*Automotive Textiles*', Textile Progress 29 (1/2) Manchester, The Textile Institute, 1999.
9. Oertel G, (Bayer), '*Polyurethanes Handbook*', Munich, Hanser, 1985.
10. Ravnitzky M (ed.) '*Automotive Textiles*', PT-51, Warrendale, PA, USA, SAE, 1995.
11. Rosato DV, '*Plastics Processing Data Handbook*', 2nd edn, London, Chapman and Hall, 1997, 121–208 & 461–94.
12. Slater K, '*Comfort Properties of Textiles*', Textile Progress 9 (4), Manchester, The Textile Institute, 1977.
13. '*Textiles and Surfacing Materials*' (*Plastics in Automotive Engineering*), Congress Papers, 25–6 March 1998, Mannheim, VDI Dusseldorf, 1998.
14. Woods G, '*ICI Polyurethanes Handbook*', 2nd edn, Chichester & New York, ICI and John Wiley, 1987.
15. Miravete A, 3-D textile reinforcements in composite materials, Cambridge, Woodhead Publishing Ltd., 1999.

## 7.1 Introduction

This chapter details other textile uses including some of the larger growth areas at the present time, driven by government legislation to improve the safety of cars. The main driving force has been the federal laws passed in the USA relating to airbags and head protection devices. The airbag in particular is experiencing quite spectacular growth and developments continue to improve its action which undoubtedly saves lives, but is believed to have caused the deaths of children and small adults in fairly low impact accidents.

As well as continuing to make the car safer, researchers are continuing to improve the comfort of car interiors. Discomfort contributes to driver fatigue, which in turn contributes to lapses in concentration and judgement causing accidents. Noise and vibration are two factors which engineers strive to control and there is no doubt that modern cars are much quieter than several years ago but the struggle continues to improve further. There are known limitations of both vibration and noise above which human health will suffer. The carpet is a key component in the pursuit of quieter interiors and a smoother ride but as with all other developments associated with the car, cost control and cost reduction are vital.

Textiles provide strength and reinforcement to many other components of the car and involve rubber and plastic composites. Rubber composites are included in this chapter but plastic composites are considered in Chapter 9. Composites are used significantly in other forms of transportation, but are not, at present, used in large components in regular production cars. Much research is being conducted to enable this to happen.

Many of the essential components of the car are made from combinations of yarn, fibre or fabric with rubbers. The best known of these are the tyres, followed by the hoses and drive belts. Tyres are usually associated more with the rubber industry but their physical performance depends to a large extent on the properties of the reinforcing textile within. The textile

yarn in all rubber composites has to have good dimensional stability, and as low heat shrinkage properties as possible so they do not move during the vulcanization process or during use. Being embedded in rubber will not prevent the shrinkage, which can distort the article and contribute to premature failure. The general relationship between temperature and shrinkage of polyester yarn appears in Fig. 4.7. Textiles are also used in composite form with specialist rubbers and other materials in seals, diaphragms, gaskets, clutch and brake linings of all types of vehicles, and in recent years have replaced asbestos. Tests involving textile properties are listed in Table 7.1.

## 7.2 Seat belts

The wearing of seat belts in the United Kingdom only became compulsory for drivers and front seat passengers in January 1983, although all new cars made after 1 July 1964 had to have front seat belts fitted. Studies carried out in the 1970s concluded that seat belts could reduce fatal and serious injury by 50%. The wearing of both front and back seat belts is now compulsory in many countries of the world and all new cars made, contain at least four diagonal and lap seat belts each made from about 250g of woven fabric. In the USA, although all new cars are fitted with seat belts, individual state laws vary and not all drivers or passengers wear them. This has produced a different situation with airbags compared to Europe, as will be seen.

The narrow fabric is a multiple layer woven twill or sometimes satin, using typically 320 ends of 1100 dtex or 260 ends of 1670 dtex high-tenacity continuous filament polyester yarn. These constructions are chosen because they allow maximum yarn packing within a given area for maximum strength and good abrasion resistance – the trend is to use thicker yarns for even better abrasion resistance. Belts need to be as soft and flexible as possible along the length direction but as rigid as possible in the width direction so they can slide easily through buckles and to retract smoothly into housing. The edges must be scuff resistant but not unpleasantly hard and the material must be resistant to UV degradation and retain its strength for the life of the car – otherwise it must be replaced. Some of the first seat belts were made from nylon but they are now almost exclusively made from polyester because of its superior resistance to UV degradation.

Spun-dyed yarns are used but other colours are produced by pad thermostol dyeing using selected dyes. These dyes must have excellent resistance to light and high wet crocking and perspiration fastness. Loomstate fabric is about 5 cm wide, weighing approximately 50 g per linear metre, but during fabric finishing, some shrinkage is induced in the length direction to improve the energy absorption properties. As a result, finished fabric weight

Table 7.1 Test methods for textile automotive components

These are the main tests involving the textile component. There are many others to evaluate the whole composite item:

Seat belts	BS 3254 Part 1 1988 BS 3254 Part 2 1991 BS AU 183  SAE J114 June 1994 SAE J339 June 1994 SAE J117 BS 2576-86 Also EC regulations – see text	Restraining devices for adults Restraining devices for children Specification for passive seat-belt systems Abrasion test performance requirement Abrasion test procedure Dynamic test for seat belt systems Breaking strength test
Airbags	SAE J1538 April 95 SAE K1856 May 89 ASTM D5428-93A ASTM D5446-94 ASTM D5427-93A ASTM D5426-93 ASTM D-3786-87 ASTM D737-96 DIN 53 887	Terms and glossary Identification (at vehicle disposal) Practice for evaluating performance Physical properties determination Ageing test Visual inspection of fabric Bursting strength (diaphragm method) Air permeability Air permeability
Automotive carpets	ASTM D2646-96 ASTM D-1175 ASTM D-4723-90  ASTM D-2859-96 ASTM D-5393 AATCC Method 121-89 AATCC Method 122-89 AATCC Method 123-89 AATCC Method 138-92 AATCC Method 134 SAE J1530 August 94	Test for backing fabric Abrasion resistance Method and specifications for heat and flammability FR test method Fogging Visual soiling Service soiling Accelerated soiling Shampooing Electrostatic Nature Test for abrasion and loss of fibre
Tyre cords	ASTM D 885-94  ASTM D 885-94 (M) ASTM D 4974-89 ASTM D 2692-89 ISO 4647  ASTM D2138 BS 903 Part A48	Method of testing tyre cords/tyre cord fabrics As above – metric Shrinkage of tyre cords (Testrite Oven) Air wicking of cords 'H-pull' method for adhesion of rubber to cord Test for adhesion of rubber to cord Test for adhesion of rubber to cord
Hoses and belting	ASTM D413-93 BS 903 Part A12 DIN 53530 ISO 36	Rubber to textile adhesion test methods Rubber to textile adhesion test methods Rubber to textile adhesion test methods Rubber to textile adhesion test methods

is approximately 60 g per linear metre. This controlled limited non-recoverable, i.e. not elastic, stretch reduces some of the deceleration forces on the body being restrained during a collision.<sup>1,2</sup> Some seat belts are lightly coated to improve cleanability, durability, ease of passage in and out of housing and to impart some antistatic properties.

BS 3254; 1960 requires a belt to restrain a passenger weighing 90.7 kg (about 14 stone) involved in a collision at 50 km/h (about 30 m.p.h.) into an immovable object. In an actual car accident the front of the vehicle will crumple, usually by design, causing very rapid deceleration forces on the human body. The standard takes this and other factors into consideration and specifies minimum performance requirements for the seat-belt webbing. This first standard was replaced by BS 3254 Part 1 1988, 'Restraining devices for adults' and BS 3254 Part 2 1991, 'Restraining devices for children'. Minimum belt widths are specified, 4.6 cm minimum for the waist strap and 3.5 cm minimum for the shoulder strap for adults. Minimum belt widths are also specified for children depending on their weight, 2.5 cm for the smallest (9 to 18 kg) and 3.8 cm for larger children (18 to 36 kg). The belts should be tested for breaking strength using BS 2576; 1986, breaking strength and elongation-strip method for woven textiles. Minimum breaking forces for adults are 13.3 kN for the waist strap and 10 kN for the shoulder. Some manufacturers however work to a minimum of a straight pull tensile strength test result of at least 30 kN/5 cm. Other tests include accelerated ageing and in the made up form, fastening and unfastening 10000 times. Seat belts are also governed by standards ECE R16, ECE R44 and EEC 77/561 and Construction and Regulation use 46/47/47A. Seat Belt fabric is scrupulously examined for defects, usually by electronic means and the manufacturers are subject to both national government and European Union regulations. The main textile tests appear in Table 7.1.

A total of about 14 m of seat belt fabric weighing about 800 g are used in each car made, which amounts to about 32 000 tonnes every year. Recycling was believed to be feasible because of uniform composition and ease of removal, but a return scheme has been recently abandoned by one of the major yarn suppliers because of logistical problems.<sup>3</sup> Seat belts are mainly black in Europe, light grey in the USA and Japan, but this is now changing to harmonize with interior colours.

Much research has gone into child restraint systems (CRS) in the USA where individual state laws have been in place since the early 1980s involving various test methods; the Federal Standard is FMVSS 213. CRS development also involves child seat design, suitable washable fabric, seat comfort and ease of use.<sup>4-6</sup> An advanced seat belt material, Securus (AlliedSignal) is claimed to limit the decelerating forces exerted on the human body. Other seat belt developments combine protection with airbags and there is an airbag which inflates from the seat belt away from the body.

The use of seat belts for passengers in coaches is growing following several recent serious coach accidents.

### 7.3 Airbags and related products

Airbags have only come into widespread use over the last 5 years or so but in fact have been around for more than 30 years. The growth in their use has been quite spectacular, mainly because of legislation in the USA. The federal safety standard, FMVSS 208 requires all passenger cars sold in the USA to have airbags for both the driver and front-seat passenger. A second federal standard FMVSS 201, requires 10% of cars to be fitted with some type of head protection by May 1999.<sup>5,6</sup> The standard does not specify the device by which this should be achieved and so it could be a type of airbag or some kind of padding in the headliner area of the car. FMVSS 201 requires all cars made by May 2003 to be fitted with some head protection facility. There is a higher proportion of vehicles in the USA – SUVs and light trucks – which have a higher centre of gravity than cars, leading to more roll over types of accident and head protection is especially relevant in these circumstances. In Europe BMW introduced a head protection device, an ‘inflatable tubular structure’ (ITS), sometimes called ‘the sausage’, and also a side impact airbag in their 7-series which will be extended to their 5- and 3-series of cars. In fact a BMW concept car featured 12 airbags.<sup>7</sup> Rear passenger airbags are being developed as well as side airbags which provide protection in roll-over accidents by shielding the occupants from side window glass and protecting the head.<sup>8,9</sup> Airbags have even been suggested for protection of the knees and legs. Autoliv have three different head protection systems, the combined Head and Thorax bag (HAT-bag), the ITS and the inflatable curtain (IC).<sup>10</sup> Volvo installed an Autoliv side airbag during June 1994, the world’s first side airbag and a short time after, Volvo were also the first OEM to use an inflatable curtain, which is held inside the headliner and covers the length of the car interior.

The world market for airbags in 1998 was worth \$5.5 billion and is expected to reach \$7 billion in 1999 – and there is still room for considerable growth in both front passenger airbags, especially in Europe and Japan and side impact airbags, especially in the USA. Airbags operate by a triggering device, which sets off explosive chemicals when it senses an impact at above approximately 35 km/h is about to happen. This causes the bag to inflate, which cushions and restrains the human body from hitting a harder object. It inflates and deflates all within a fraction of a second – less than the time to blink an eye. The fabric from which the bag is made must be able to withstand the force of the hot propellant chemicals and more importantly they must not penetrate through the fabric to burn the skin of the car occupant.<sup>11</sup> Polyester is not used for airbags because its thermal

properties are not suitable. Compared to nylon 66, about 40% less heat is needed to melt polyester and the fabric could allow the penetration of hot gases.<sup>12</sup>

The first airbags were Nylon 66 coated with Neoprene rubber (DuPont), but in efforts to make bags both lighter and thinner to fold up into a compact pack, silicone coatings soon followed.<sup>13</sup> There has been considerable research and development to improve the deployment, the design and also the production efficiency of airbags. The huge volumes involved – not to mention the life preserving factors – justify the effort being put into airbags and all associated safety devices. To save weight and cost, uncoated fabrics have appeared which make use of fabric construction to control air permeability and these appear to be the preferred option for the future. However there are advantages and disadvantages for both coated and uncoated fabrics. Coated fabrics do not fray, are easier to cut and sew and air porosity can be controlled better. Non-coated fabrics are lighter, softer, less bulky and can be recycled more easily. The sizes of air bags vary with the car they are going into and also whether they are to be used for the driver or the passenger. In Europe, driver-side airbags are about 40–65 litre capacity, whereas front seat passenger airbags are a little larger, about 60–100 litre capacity. Airbags in the USA are generally larger than European ones because in Europe, the airbag is designed for use in conjunction with a seat belt, whereas in the USA not all drivers use seat belts and instead rely on the airbag alone for protection.

Airbags are typically woven from high tenacity multi-filament nylon 66 yarns in the approximate dtex range of 210 to 840 with 470 being the most frequently used in Europe and Japan.<sup>14,15</sup> Fabric weights, uncoated are about 170 and 220 g/m<sup>2</sup>. A small amount of nylon 6 is used which is claimed to be softer, minimizing skin abrasion and also, to have better packing compactness. Autoliv has developed a ‘one-piece weaving’ double-layer system which produces airbags directly from the loom.<sup>10</sup> Airbag fabric is not dyed but needs to be stabilized by heat setting and scoured to remove impurities, which could mildew or cause other problems. The fabric must be strong with high tear strength, high anti-seam slippage and needs to have controlled air permeability, usually measured using ASTM D37-75 or DIN 53877.<sup>16</sup> It must be capable of being folded up in a small space for over 10 years or more without deterioration and, in the case of coated fabric, without blocking or sticking together. Some tests specify 75% property retention after 4000 h at 90–120 °C, the equivalent of 10 years UV exposure and also cold cracking down to –40 °C. A selection of the main test methods is in Table 7.1. DuPont have tested two of their airbags in nylon 66, one coated and one uncoated, which were installed in a car in the 1970s and found no loss in performance after 16 years. The new nylon 4.6 recently introduced by AKZO has a melting point of 285 °C and should be well

suited for airbags, although its extra cost is a disadvantage. Improved thermal performance can be obtained by coating.

In the USA, the National Highway Traffic Safety Administration (NHTSA) estimates that 4750 people are alive today (9 December 1999) because of their airbags.<sup>17</sup> NHTSA also estimates that the use of an airbag in combination with a lap/shoulder belt reduces the risk of serious head injury by 81% compared with 60% reduction by use of a belt alone. Although airbags undoubtedly save lives they are believed to have caused the deaths, in the USA, of an estimated 148 persons in low-severity accidents since 1990. These included 42 female drivers, out of a total of 56 drivers, 68 children (aged between 1 and 11 years) and 18 infants. Analysis showed that many of these persons were not wearing a seat belt and were sitting close to the steering wheel or airbag. This has resulted in considerable research and development work for reliable 'smart' airbags which can sense the size of the seat occupant or even if the seat is unoccupied and deploy accordingly. Other designs have been put forward including an airbag, which deploys outwards from the seat belt.<sup>18,19</sup> Research is also directed towards gentler inflation and less abrasive fabric material. Injuries caused by airbag inflation include eye damage, fractures, bruises and chemical burns caused by penetration of the inflating material through the fabric. Integrated safety systems especially for children are being developed. Airbags are not yet compulsory in Europe and it has been suggested that tests should be carried out to determine the most suitable for use in conjunction with seat belts which are compulsory and which are in widespread use. Recently there seems to be some progress in the development of airbag fabric from non-woven material.<sup>20</sup>

Statistics compiled by the World Health Organization in 1998 record that world wide 500 000 persons are killed and 15 million injured in traffic accidents every year. This is expected to increase sharply as car ownership increases in the developing nations and also as the young adult populations grow. Traffic accidents are among the main causes of premature death in many of the developed counties and efforts are being made to reduce this by several means including making cars more safe. In the USA there is a whole series of Federal Motor Vehicle Standards (FMVSS) aimed at improving car safety.<sup>5</sup> These include: FMVSS 201—head protection for cars and light trucks, 100% compliance by May 2003; FMVSS 208—airbags for both cars and light trucks, 100% compliance by September 1998; FMVSS 213—child restraint systems, 100% compliance by August 1994; FMVSS 214—side impact for passenger cars and light trucks, 100% compliance by September 1998; FMVSS 581—bumper properties.

Car occupant safety is becoming an electronic 'high tech' industry with the development of sensor systems for the seat belt, for anticipation of type of accident, e.g. roll over, side impact etc. and for the airbag.<sup>21</sup> These sensors

activate the relevant components to optimize the protection performance. In the USA, new legislation is expected in the near future to regulate advanced airbags. Continental analysis of airbag deployment has drawn attention to the economic cost of airbags deploying unnecessarily.<sup>22</sup> New fabric structure development continues to improve safety devices.<sup>23</sup> Recent developments with a review of expected NHTSA proposals have been summarized recently, with an account of the latest method of one-piece airbag weaving.<sup>24,25</sup> Airbag technology is summarized in a recent Textile Institute publication.<sup>26</sup>

Both polyurethane foam and polypropylene foam manufacturers are developing grades of foam with optimum properties for absorption of impact energy. Eventually every surface in the car interior will incorporate some kind of energy-absorbing material, which will not only improve comfort and reduce noise levels, but also contribute to safety. In Europe legislation is in preparation for side-impact safety, and in the not too distant future, laws are likely to appear for protection to pedestrians in accidents up to 25 m.p.h. Softer car exteriors, possibly incorporating textiles may contribute to this new challenge. There has been progress in development of external airbags, which deploy on the bonnet for pedestrian protection.

## 7.4 Carpets

This was once considered a luxury item but is now an essential part of interior trim not only for the aesthetics and sensual comfort but also because of the part it plays in noise and vibration control. There are about 3.5–4.5 m<sup>2</sup> of carpet in each car, made by either tufting or needle-punching with considerable differences depending on where in the world the car is made.<sup>27</sup> In Western Europe approximately one-third of all cars have carpets tufted mainly from bulked continuous filament (BCF) nylon yarns. The rest, about two-thirds and gradually increasing is needle-punched, mainly from polyester but also from increasing amounts of polypropylene. About the same proportion of tufted and needle-punched carpets appear in cars made in Japan, and most of the yarn used in tufting is BCF nylon, with a very small amount of polypropylene. In the USA at present all car carpets are tufted mainly from BCF nylon. The remainder is staple-spun nylon and solution (spun)-dyed fibres are being increasingly used.

The poor compression resilience of polyester prevents it being used in tufted carpets. Recently needle-punched carpets have appeared in the USA and are expected to become more widely used. An increasing trend worldwide is to produce lighter carpets using finer gauge yarn for more covering power towards the lower weights of approximately 12 ounces/square yard for tufted and 450 g/m<sup>2</sup> for needle-punched or even lower. Tufted carpets are generally more resistant to wear and tear but needle-punched carpets

have better mouldability. In addition needle-punched carpets have no tendency to exhibit 'grin through' unlike tufted carpets especially around convex curves.

Tufting is a relatively new process, many times faster than weaving, and tufted car carpets first appeared in the USA in the 1950s.<sup>28</sup> The tufts can either be cut or uncut looped pile, but the vast proportion of tufted car carpets are cut pile; uncut looped pile being used only for special effects. The most popular gauge of both cut pile and loop pile tufting is 0.1 inch. Needle-punching of car carpets is an even younger process than tufting and is an even more rapid and economical process. Needle-punching has been much refined in recent years and is now producing very attractive materials that are comparable in quality with tufted carpets. Tufted carpets are standard in up-market cars in Europe, e.g. Audi, BMW, Mercedes, Saab and some Rover cars. Tufting of automotive carpets is carried out on a polyester spun-bonded, non-woven material weighing between 110–120 g/m<sup>2</sup> called the primary backing. Both AKZO (with Colbond) and Freudenberg (with Lutradur) have developed special fabrics for this purpose, which also facilitate moulding to the shape of the car interior. Recently the weight of these fabrics has been reduced by using finer fibres but the stretchability has been increased to allow deeper draw moulding which is especially important for European and Japanese markets. American cars generally have less contoured floors. Both tufted and needle-punched carpets require about 70–100 g/m<sup>2</sup> of a binder coating, usually SBR or acrylic latex on the back to stabilize it and to lock in the fibres. Another layer of a suitable material is then applied to both types of carpet to confer good thermo-mouldable properties. This is important for process efficiency but also to produce a good fit to reduce vibration, and to maximize noise insulation.<sup>29,30</sup> Polyethylene powder is used on both tufted and needle-punched carpets for this purpose and about 250–600 g/m<sup>2</sup> are applied by powder scattering and infra-red heating. The correct thermal characteristics are critical, because no softening must occur at temperatures below 90 °C but softening should occur sharply, in the region of about 110–140 °C, which is the temperature at which moulding is carried out. An alternative to polyethylene powder, used mainly on needlefelt carpets is a layer of thermoformable fibres which is needled on to the back of the needle-punched carpet. These thermoformable fibres must also have the same thermal characteristics already mentioned. In older plants, the thermomouldable layer is a further much heavier coating of SBR latex filled with chalk, (calcium carbonate) or barytes (barium sulphate), a heavy material.

All carpet materials have to be selected for mouldability, good adhesion to the fibre and other substrates and for heat stability to withstand further processing in the car factory and also for durability during the life of the car.<sup>31,32</sup> After the application of the thermomouldable layer the carpet is

thermomoulded to the shape of the car to which it is to be fitted. A good fit is essential for good acoustic control and for ease and efficiency in installation and it must be dimensionally stable under all conditions of temperature and humidity.<sup>33,34</sup>

Many cars now have a sound absorption barrier layer of barium sulphate-filled EVA/EPDM polymer, weighing approximately 2000–7000 g/m<sup>2</sup> which is laminated to the thermomouldable layer before thermoforming. The combination of a heavy layer against a flexible padding layer is beneficial to reducing noise inside the car. Up-market cars will also have an extra noise and vibration insulation layer between the carpet and the vehicle floor, see below.

Carpet manufacture is made more complicated by the holes and gaps required for cables and ducting and provision must also be made for the fitting of seats and control consoles. Certain areas of the carpet will have extra heat insulation pads for example the part at the front facing the engine. As well as being an essential item for comfort providing thermal and noise insulation and vibration damping, carpets now contribute directly to safety through the use of energy-absorbing backing foam. In a similar way to the headliner, the car carpet has become a complex module system in its own right.

In addition to fitted car carpets there is also a sizeable market for secondary carpet mats – known as ‘thrown in’ or ‘option mats’ totalling perhaps 4 million m<sup>2</sup> in Western Europe alone.

#### 7.4.1 Noise control

Sound is propagated through the air and by vibration of the car body and there are three basic mechanisms for reducing it: by absorption, by damping and thirdly by isolation or insulation.<sup>35</sup> In general a thick piece of material will absorb more sound than a thinner piece of the same material. There are a number of layers of material and permutations of layers of materials used in noise and vibration damping, see Table 7.2. Density, air porosity and thickness of the material influence sound absorbency, but actual frequency of the sound waves is also relevant.<sup>36</sup> Damping can be obtained by putting soft materials next to a harder material such as the metal car-body structure. Efforts to isolate engine vibration and noise are made by special design of engine mounts and the car suspension to isolate it from the passenger compartment. Engineers are also constantly trying to improve the fit of doors and windows and to eliminate all the bangs, squeaks and rattles in cars.<sup>37–43</sup> Flock-covered parts, both plastic and textile are sometimes used for this purpose.<sup>44,45</sup>

Once only luxury cars had a noise insulation pad under the carpet but as in many cases this has become or is becoming a standard requirement.

Table 7.2 Automotive carpet structure

Layer	Materials used
Top decorative layer	Tufted BCF nylon or needle-punched polyester or polypropylene-back, latex coated with SBR or acrylic latex
Thermoforming layer	Polyethylene powder, meldable fibres, EVA or a further thick layer of compounded SBR latex
Acoustic layers	'Heavy layer' of EPDM, shoddy fibres or polyurethane foam

Luxury cars have more than one acoustic layer. Bitumen is also used in many cars as a further layer next to the metal.

Bitumen sheeting is widely used but this is now supplemented with resinated waste or shoddy fibre. These materials generally have to be fitted in small pieces, which is time consuming and produces an insulation performance which is inferior to that of a continuous layer. In some vehicles this insulation layer is formed directly on the back of the pre-formed carpet itself by back injection moulding using polyurethane foam.

A barrier film on the back of the carpet is necessary to prevent liquid foam from penetrating to the carpet surface during moulding.<sup>43</sup> This is considered a more satisfactory method giving more consistent results and the objective is to obtain maximum sound absorption with the lightest material possible. Various types and densities of foam and non-woven fabrics have been evaluated at different vibration frequencies.<sup>36,46</sup>

A method has been developed for adding barium sulphate filler to a polyurethane elastomer which is then froth-coated directly on to the back of the carpet. This produces a sound-insulating 'heavy-layer' in a reduced number of manufacturing steps and with much reduced fogging.<sup>47</sup> Recently developed foams by ICI (now Huntsman) allow the individual noise and vibration characteristics of a vehicle to be selectively damped by tailoring the foam properties to suit the particular vehicle. Large sections of floor covering can be precisely moulded to the shape of the vehicle's floorpan to enhance acoustic absorption as well as contributing to assembly efficiency.<sup>48</sup>

Engineers working in research departments in carpet manufactures, OEMs as well as university departments are applying much effort to reduce noise and vibration. Collins and Aikman have a test dummy in their

Michigan acoustic laboratory, called Oscar, which is equipped with specially designed ears to locate the origin of noises.<sup>29</sup> This laboratory is one of the most up-to-date in the world for the investigation and elimination of noise, vibration and harshness (NVH). Noise frequencies and levels are characteristic of each individual car model and the materials and specific designs have to be individually optimized.<sup>35,38–40,43</sup> The carpet, headliner and parcel shelf are probably the three major items by which interior noise can be controlled. However all the components in a car will influence noise levels, and it is difficult to separate individual contributions. The best tests are done on the car as a whole, on the road – where the ultimate tests will be carried out, by the customer. Noise contributes to driver fatigue, a major cause of accidents and reducing it is a valuable contribution to road safety.

Road noise is now considered a form of environmental pollution. The EU and national governments are applying pressure to OEMs to reduce *external* car noise levels by 3 dB, from 74 to 71 dB, which means by a factor of 50% because noise is measured on a logarithmic scale.<sup>49</sup> Textiles are also contributing to overcome this problem, see the section on wheel-arch liners below.

## 7.5 Cabin air filters

There are about a dozen different kinds of filter used in cars but only about half use textile materials.<sup>50</sup> Paper is used in many applications such as the oil filter and carburettor air filter, although non-wovens are used in some Japanese cars for the latter application. An important potential growth area is the cabin interior air filter. Once again this was once a luxury item which is becoming more and more a standard requirement as living standards improve and competition becomes more intense between the OEMs. Recent research has shown that the air quality inside a car can be several times poorer than the air quality outside, especially if the car is driven closely behind another vehicle. This is referred to as the ‘tunnel effect’, the consequence being the same as a car driven through a tunnel. The concentration of exhaust gases inside can be as high as six times or more the level of that on the outside. In addition to exhaust gases, car occupants are also exposed to windscreen-washer-fluid odour, agricultural odours of fertilizers and manure, industrial fumes, pollen, spores and even viruses and bacteria.<sup>51</sup>

Dust particles and pollen can cause allergic reactions and diesel fumes and aromatic hydrocarbons can be even more damaging to health. Particle size covers the range from 0.001 micron up to 100 microns. Particles in the region of between 2 and 5 microns originate mainly from combustion and industrial processes, i.e. man-made and comprise heavy metals, carbon and

sulphur. Larger particles than this are generally naturally occurring substances including, sand, soil, pollen spores and bacteria. Large particles are deposited in the nose and upper respiratory passages and the particles that are smaller than 10 microns – the PM10s are mainly deposited in the lower respiratory tracts. Studies have shown that the vast majority of particles in the air are smaller than 1 micron, and if breathed in, can remain in the respiratory system for long periods of time. They are therefore potentially, the most damaging to human health. See also Chapter 8.

Cabin filters have been developed in response to consumer requests and have been fitted to up-market production cars for several years, notably in Europe. There are three basic ways in which the filters work. The first is by mechanically filtering out solid particles through fine pores in the nonwoven fabric. The second is by imparting an electrostatic charge to the fibre, which then attracts solid particles electrostatically. The third mechanism, is by the use of activated carbon which adsorbs gases and is therefore also capable of removing odours.<sup>52-55</sup> Activated carbon consists of very small and finely divided particles each with an internal pore structure which presents a very large surface area available for the adsorption of gases. To maximize the effect, activated carbon granules are arranged in the filter to present the maximum surface area and 200g of the material in theory offers a total surface area of 200 000 m<sup>2</sup> available for gas adsorption. See Figs. 7.1. and 7.2.

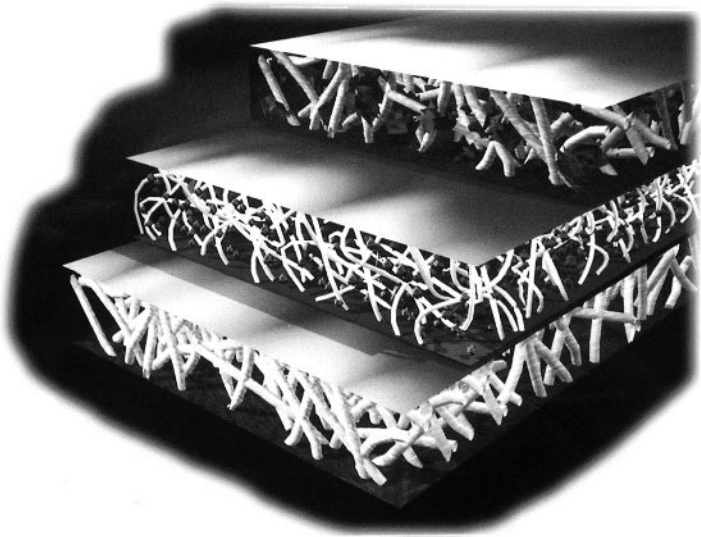

7.1 Three layer nonwoven filter material. Airflow is from top to bottom; through the top prefilter, the middle Microfiber filter and through the bottom carrier. Photograph supplied by Freudenberg and reproduced with kind permission.

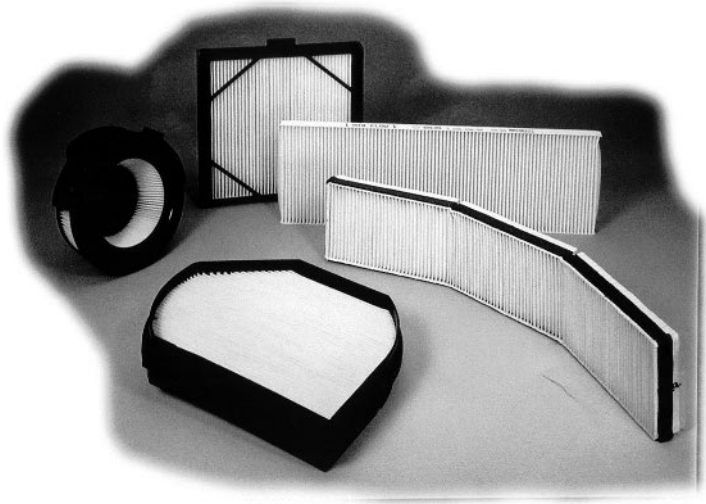

7.2 micronAir brand particle filters; Customer-specific models made with five manufacturing techniques. Photograph supplied by Freudenberg and reproduced with kind permission.

The latest advanced filters combine both mechanical filtering through polypropylene non-woven electret fabric with adsorption by activated carbon.<sup>55</sup> Filter fabric is arranged in a pleated form to provide maximum surface area with minimum airflow resistance. The adsorption and retention capacity of the filter for odours in a given airflow rate is a measure of the filter's performance. The non-woven filter fabric itself must be strong when wet, be odour-free, resistant to micro-organisms and resistant to extremes of temperature.<sup>56-59</sup> AlliedSignal recently announced a filter for both particles and odours, which uses a system that is based on microfibres and a special liquid absorber.<sup>60</sup>

The majority of new European cars are equipped with some kind of basic particulate filter whereas in the USA, at present they are only fitted to 10% of cars. The more advanced odour-removing combination-type filter, however, is gaining in popularity because the average person is more readily aware of odour removal than particulate removal. The first cabin filters were fitted in 1993 to luxury standard cars such as the BMW 5 and 7 series and Mercedes 'S' class. This situation has changed quite rapidly. The first high-volume production cars to have a combination air filter fitted as standard were, since 1999, the Volkswagen Golf and the Mercedes C and E class.

One of the main constraints, apart from added cost, is the accommodation of filters into the restricted space in the vehicle but they can be tailored to suit the space available. The filter should have minimum effect on

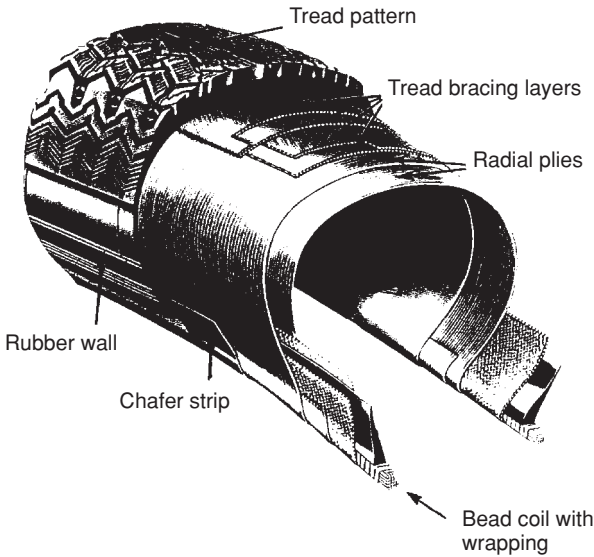

7.3 Textile components of a car tyre. Simple diagram showing the main textile components. From an illustration provided by the British Rubber Manufacturers' Association and reproduced with kind permission.

the air pressure being drawn into the car and should also have minimum influence on the efficiency of the fan, which has the important task of removing frost and condensation from windows. The filter should also retain its effectiveness for as long as possible, although it can be replaced with a new one during routine servicing. The particulate matter it removes from the air will eventually block a filter, and this will further reduce airflow. The actual life expectancy of the filter will depend on the levels of air pollution; in general present filters last between 15000 to 40000 km (i.e. 9500 to 28000 miles) of use. Further improvements in performance, life-span and fan air pressure drop can be expected as more competitors enter this area. The present market leaders are Freudenberg with their micronAir brand product, which includes polyester, and 3M with their Filtrete brand range using polypropylene. 3M believe their fibrillated filter fibre, which is flat and rectangular in shape, provides a greater charge compared to the more conventional round electrets. A recent comprehensive review of all car filters is available.<sup>59</sup>

## 7.6 Battery separators

Every battery needs a separator of some description to mechanically separate the anode from the cathode and to prevent short circuits. The general

battery classification is into two types; primary cells, which cannot be recharged and secondary cells such as the lead–acid cell which can be recharged.<sup>61–63</sup> Electric lead–acid batteries such as those used in motor cars consist of two plates, an anode (+) and a cathode (–) in dilute sulphuric acid. When discharging, chemical reactions take place, the anode is converted from lead peroxide to lead sulphate and the cathode from pure lead to lead sulphate. There are lead–acid batteries of different design depending on the vehicle in which they will be used. For example ordinary cars require a single high initial load to start the vehicle, for lighting and ignition (SLI), whereas vehicles such as milk floats and fork-lift trucks need a continuous discharge to actually move them. Each battery has a number of cells and the output is about 2 volts per cell. Thus for 12 volts there will be 6 cells. Lead sulphate particles build up on the battery plates and need to be retained, otherwise they would eventually cause a short circuit. This is achieved by a physical barrier or a separator.

Fibreglass was once used extensively, but in the search for more economical materials, polyester has been found to be suitable for this application, which requires stability to acid conditions. The material must allow the flow of electrolyte but prevent actual particles migrating, and in addition it must have some measure of vibration resistance. Actual plates in car batteries are quite small, requiring pieces of fabric about 15 cm × 15 cm but in fork lift trucks, golf carts, milk floats and other electric vehicles they can be 15 cm × 35 cm or much larger.

The Japanese market in 1998 was about 2 million m<sup>2</sup>, which could increase to several times this figure if electric vehicles are produced in volume.<sup>63</sup> Tubular-woven polyester fabric is used for some secondary cells. To stabilize it and to help with fabrication the fabric is impregnated in a specialist acrylic resin, e.g. certain Primal grades from Rohm and Haas. An effective well-designed separator is essential for long battery life – 6 years is now a common requirement. With the concern for reduced atmospheric pollution, and the interest in alternative methods of powering vehicles, battery separators offer a potentially significant growth area. The state of California, requires by the year 2003 that 10% of all cars offered for sale must have zero emissions and electric vehicles are likely to have a role to play. Growth in the requirement for general automobile batteries to the year 2000, is believed to be about 5%, whereas that of batteries for electric-powered vehicles is forecast at 7%.<sup>64</sup>

## 7.7 Bonnet (hood) liners

These are generally made from a laminate material the main function of which is to absorb and dampen engine noise. The main constituent is generally phenolic-resinated waste shoddy fabric or fibreglass usually lami-

nated on both sides with non-woven fabric. The covering side facing the engine needs to be resistant to fluids such as oil, fuel, windscreen-cleaning fluids and water and this can be improved by a fluorocarbon finish. The effectiveness of the sound absorption has to be balanced by increased weight – generally the thicker the liner – the better the noise insulation. Both polypropylene and polyester non-wovens are used in this application. The adhesives used for lamination have to be resistant to fluids and heat and they must be durable to last the life of the vehicle. Polyurethane foams, which have the advantage of lightness, are sometimes used in place of the shoddy material. More recently, bonnet liners are being designed entirely in polyester or entirely in polypropylene to facilitate recycling and to remove the fibreglass, a potential skin irritant. Spun-bonded non-wovens, such as Lutrador (Freudenberg), are well-suited because they allow deep-draw, well-defined moulding to the required shape.

## 7.8 Wheel-arch liners

These external components are a relatively new application for textiles but are becoming more important in the quest for road noise reduction and increased road safety. As well as significantly cutting down noise, they also reduce spray in wet conditions and protect the bodywork against stone impact and corrosion. Performance and properties are covered by DIN 661151 and DIN 61210.<sup>65</sup> Needle-punched polyester and polypropylene that is coated with specially formulated SBR latex have been found to be suitable material. They replace PVC and EPDM which are stiffer, harder, less flexible and heavier than the textile alternatives, and not as effective in reducing noise or spray. The textile is more effective because of its porous structure, which disperses water into smaller droplets and this helps to reduce road noise. In addition, the use of textile material in place of the heavier plastic reduces car weight by about 3 kg. Wheel-arch liners are also used inside the car to assist with insulation from road noise for the car occupants.

## 7.9 Hood material for convertibles

A variety of coated fabrics have been used for this application including rubberized cotton fabric and PVC-coated cotton, nylon and polyester. PVC is still used in some volume-production models but more up-market vehicles now use a triple-textile laminate with spun-dyed acrylic fibres in the top layer. This outer material has to be extremely well engineered to be resistant to UV and other sunlight radiation, rain, frost, ozone, micro-organisms, dirt and traffic fumes as well as car-wash chemicals for the life

of the car. In addition it needs to be dimensionally stable under all weather conditions and have excellent abrasion resistance.<sup>66</sup> Soil resistance is achieved by application of a fluorocarbon. The market leader is Dolan 25, now being replaced with improved Dolan 65, both made from Acordis acrylic fibre.<sup>67</sup> Aesthetics are important as the vehicle top is very visible and its appearance must be integrated into the rest of the vehicle design.

Cotton is now unsuitable for any part of the convertible top because it will not pass tests for weathering and resistance to micro-organisms. Polyester twill-woven fabric is used for the inner surface of the triple laminate and the middle layer is rubber. The recently improved Dolan 65 now uses acrylic yarns both in the warp and weft of the top layer. Earlier versions of this product used acrylic only in the weft with polyester in the warp, but the polyester warp hydrolysed in subtropical locations of the world. At present only spun-dyed acrylic satisfies all the demanding tests; the latest UV stabilized polypropylene fibres were evaluated but certain processing problems could not be overcome.

The fabric is tested for weather resistance using a test such as DIN 53387 and also specially designed sagging tests at 75 °C with a weight hung on the end of the test strip of material. The percentage of permanent elongation after a 24 h test period is calculated from measurements before and after testing. These laboratory tests are correlated with outdoor exposure tests in the southern states of America. SAE tests for exterior materials include, J1960 JUN 89 (accelerated exposure using water-cooled xenon-arc), J1961 JUN 94 (accelerated exposure using Solar Fresnel-Reflective) and outdoor weathering test J1976 FEB 94.

## 7.10 Tyres

The modern tyre has its origins in the work of three pioneers, Goodyear who discovered vulcanization of rubber in the USA in 1839, RW Thompson, a Scottish engineer, who developed and patented the concept of the pneumatic tyre in 1845, and Dunlop, who in 1888 first used textiles, a canvas fabric, as rubber tyre reinforcement. Early tyres used woven fabric which was later replaced by a unidirectional arrangement of cords sometimes with a small number of weft threads across them.<sup>68,69</sup> The cords are formed by twisting yarns together to build up a strong cord in two or three separate operations. Twist direction is usually in the same direction for the first two operations and in the reverse direction for the final process. The car radial tyre contains about 4 to 7% of its total weight of textile material; cross-ply tyres contain much more, about 21%.<sup>70</sup> Radial tyres have a steel cord 'breaker' layer between the rubber and the textile ply for added resistance to shock. The force of local impacts, stones for example, are spread out over

a wider area. Tyre production in the UK is quite constant at the present time at about 35 million units per year. Of this total, about 5 million tyres are for off-road vehicles and aircraft.<sup>70</sup>

Cotton was replaced by the first man-made fibre rayon but not until the problems of bonding the rubber to rayon were overcome. Cotton, composed of staple fibre with many fibre ends and having a rough surface, stuck quite well to rubber but a resorcinol–formaldehyde latex (RFL) bonding system was required to promote adhesion of the smoother rayon to rubber.<sup>71</sup> Improvements continued and eventually high tenacity rayon yarns were developed. When nylon became available during World War II, it was used first in aircraft tyres where toughness and light weight were the important parameters, but again the fibre–rubber bonding problem needed to be overcome, this time using a modified RFL system. Both nylon 6 and 66 were used but these fibres have the disadvantage of ‘flatspotting’ which is not generally acceptable for private cars and this has restricted their growth. Nylon however is used in some Japanese cars, which are sold in countries, which have poorer road surfaces than Europe or the USA. In addition nylon is used extensively on tyres for off-the-road vehicles such as tractors and other farm vehicles.

In the years after World War II, intense competition between rayon and nylon led to improvements with both fibres. Steel cords and polyester tyre cords, which appeared during the late 1950s and early 1960s, resulted in the decline of rayon in passenger-car tyres, especially in the USA, although significant amounts are still used in Europe. Some manufacturers still consider rayon to be the most satisfactory tyre cord because of its thermal stability.<sup>72</sup>

Much work needed to be done to develop an effective polyester–rubber bonding system. When this was accomplished polyester tyres became very successful in passenger cars but not for aircraft or heavy goods vehicles. The reason for this, is the poor dynamic performance of polyester at temperatures higher than that normally found in passenger cars, i.e. above 82 °C, the glass transition temperature of polyester. Thermal instability limitations of polyester can also give rise to problems in tyre manufacture, but despite this, polyester is the least expensive material for tyre cord, and so it is the most extensively used fibre throughout the world for car tyres. Steel cords are economical but have the disadvantages of high weight and possible moisture corrosion but they are used in radial tyres for trucks.

Tyre cord development continues with further improvements both in textile cords such as the introduction of high-tenacity, low-shrink polyester yarns and also in the continued development of fibre–rubber bonding techniques.<sup>73–75</sup> Aramids offer the highest strength-to-weight ratios coupled with high temperature resistance and are well suited to speciality cars and aircraft. Some high-performance car tyres and quality bicycle tyres are made

using aramids but the limitation for high-volume production cars is cost. Low shrinkage properties are important because yarn movement when the tyre is subject to heat during the vulcanization process or during use, could lead to distortions and reduced performance and durability.

The usual reasons for tyre performance limitations is differing elastic properties between the rubber and the introduced fibre, which in turn give rise to poor fibre–rubber bonds, the build-up of heat and hence poor durability. DuPont have approached the fibre–rubber combination by a novel route by producing very intimate Kevlar short fibre/rubber dispersions which allow the speciality properties of Kevlar, i.e. high tensile strength, high modulus and thermal and flexural performance be transferred to the rubber. The result is a tyre with better resistance to tears and cuts, punctures and actual wear. So far the new technology has been successfully applied to bicycle and motorcycle tyres and is under test for cars and other vehicles.<sup>76</sup> The ‘run flat’ tyre is being perfected which should in theory make the spare wheel redundant with the benefits of savings in weight and more storage space. Of the existing textile materials used in commercial tyres, rayon has the highest thermal dimensional stability and it may be due for a new lease of life in run-flat tyres in which temperatures can reach 270°C.<sup>72,77</sup>

In addition to cords, textiles are used in smaller quantities in holding together the bead assembly on the tyre rim. Bead wrap is generally nylon cord or light-weight woven or knitted nylon pre-treated with adhesive to stick to the rubber. Nylon fabric is also used as the chafer material, which protects the tyre during manufacture and helps maintain the shape during curing.

The disposal of old tyres is a serious environmental problem and mention is made of the issues associated with landfill in the next chapter. The Environmental Agency has made a detailed study of this and has published its findings and recommendations.<sup>70</sup> These include, the development of longer lasting tyres which promote energy efficiency, producing road surfaces and tyres which reduce noise pollution, and also by encouraging better care of tyres by more careful driving and less use of the car. Recommendations are also made for environmentally sustainable ways of recovering old tyres as a useful resource.

The frequency of rubber symposia, many featuring textile–rubber bonding provides some indication of the amount of research being conducted in this area. Tyre makers strive to further reduce rolling resistance, reduce weight, road noise and improve wet performance. One estimate states that a 35% reduction in rolling resistance of all tyres would save 5% of fuel consumed – equal to five billion litres of fuel in Germany alone.<sup>78</sup> A new all-steel cord tyre development recently announced developed by Goodyear using their new Ultra-Tensile-Steel reinforcement in a new

process, termed 'Impact Technology', is reported to produce a tyre of better quality than all existing tyres.<sup>72</sup>

## 7.11 Hoses and belts – general considerations

The performance of these articles also relies very much on the bond strength between the textile and the rubber matrix. Development work continues to improve this using both chemical methods and also newer surface-treatment methods.<sup>73–75</sup> In a similar way to tyres many benefits have been made possible by the invention of high-performance fibres which continue to be improved. Both hoses and belts rely almost entirely on the textile component for actual physical strength and various fibres have been used, including cotton, rayon, glass, nylon and polyester.

Rayon loses strength when wet and the rest have certain other limitations. At present specialist polyester yarns are the most frequently used; aramids are used when extra performance is needed and cost can be justified.<sup>79,80</sup> General requirements are dimensional stability, moisture, oil, chemical and temperature resistance, strength and of course good adhesion to the rubber. Similar to tyres low shrinkage and heat stabilized yarns are essential to withstand temperatures of vulcanization and conditions of use. As in all transport applications, weight saving is important and in under-the-bonnet components, space saving is especially relevant. Hoses and belts are only small items but their high performance, without deterioration over several years in extremely demanding conditions is essential to the reliability of the vehicle.

The type of rubber used depends on the application and the conditions of use it will have to withstand. A summary of rubber types appears in Table 9.3 in Chapter 9 plus some comments on compounding. The types most used in automotive components are chloroprene (best known is Neoprene, (DuPont), which has good oil and heat resistance, acrylonitrile-butadiene (ABS) rubber, which is probably the best high volume rubber for oil resistance and butyl rubber, which has good strength-to-weight ratio and excellent heat and chemical resistance.

Compounding the various ingredients together is a highly specialized operation – there are many dozens of different recipes with a minimum of perhaps eight components – each one tailored for a different application and customer. The textile rubber composite needs to be resistant to the materials the hoses or belts come into contact with and also oxygen, moisture and all the various ingredients in the compound mix. These will include, chemical stabilizers, vulcanizing (cross-linking) agents and other additives – some of which themselves sometimes initiate premature breakdown. The chlorine in some chlorine-containing polymers can, with ageing, form hydrochloric acid, which is capable of degrading the textile.

Tests applied to belts and hoses include heat ageing, low-temperature resistance, weathering, fatigue and flex cracking, resistance to swelling in relevant liquids and rubber–textile adhesion determinations.<sup>81,82</sup> The latter property is assessed by ply-separation as detailed in BS 904 or ASTM D413. An account of belts and hoses is included in a recent review of textile progress.<sup>83</sup>

### 7.11.1 Hoses

A variety of different fabric manufacturing techniques are used; knitting, circular weaving, wrapping, and for high-pressure uses, filament spiralling and braiding. Cotton was first used but this has been replaced with synthetic fibres, which provide higher strength, more durable flex and abrasion resistance and better rot resistance. High-tenacity yarns allow weight reductions and less bulk. For the highest performance of heat and strength, aramid fibres such as Nomex and Kevlar (both DuPont) are used.

Automotive hose products include fuel, oil, radiator heaters, hydraulic brakes, power steering, automatic transmission and air conditioning pipes. Nylon is not generally used in hoses because of its high extensibility but this specific property is useful in the expanding part of power steering hoses. These items are only small but reliability is extremely important and testing to the highest standards is essential. The manufacturers have designed special test rigs, which simultaneously measure performance to high-pressure, ambient temperature, fluid temperature and vibration.

### 7.11.2 Belts

Again cotton was first used but was replaced as soon as synthetic fibre–rubber bonding difficulties were overcome, and now synthetic-fibre specialist high tenacity yarns are used in cord form. High tensile strength, excellent flex resistance, excellent shock resistance and low extensibility are amongst the requirements for a long belt life. The V-belt is shaped for maximum friction grip as well as high strength with compactness and is composed of cord made from HT yarn such as the Trevira 700 series and rubber, usually chloroprene, covered with a fabric/rubber jacket.

Textile-toothed belts have almost completely replaced chain drives in cars because they are quieter, weigh less, need no lubrication and allow a more compact design. Textile belts are more flexible and smaller pulleys can be used compared to chain drives. Testing of belts needs to be carried out thoroughly to simulate wear in the shortest possible time. This is no easy task because there are mechanical, chemical and physical factors to consider.

## 7.12 References

1. Morris WJ, 'Seat Belts', *Textiles*, 1988, 17(1), 15–21.
2. Roche C, 'The seat belt remains essential', *Technical Usage Textiles*, 1992, 3, 63–4.
3. Krummheur W (AKZO), 'Recycling of used automotive seat belts', *IMMFC*, Dornbirn, 22–4 September 1993.
4. Anon, 'Child restraint systems; keeping up with testing trends', *Inside Automotives*, October/November 1994, 33–4.
5. Braunstein J, '2001 and beyond, a safety odyssey', *Automotive & Transportation Interiors*, April 1996, 27–34.
6. Thompson J, 'Restraining orders', *Automotive Interiors International*, February 1998, 16–20.
7. Mound H, 'BMW gives a boost to hyperinflation', *The Times*, 12 April 1997.
8. Anon, 'Eye on environment', *Inside Automotives International*, October 1998, 14–19.
9. Crighton KN, 'Tubular side airbag technology takes another shape', *Automotive & Transportation Interiors*, April 1995, 16.
10. Sonderstrom P, 'Side impact airbags, the next step', *Inside Automotives*, May/June 1996, 12–15.
11. Davidson A, 'Growing opportunities for airbags', *TTi*, May 1992, 10–12.
12. Smith TL, 'Tough stuff', *Automotive & Transportation Interiors*, August 1996, 30–2.
13. Bohin F & Ladreyt M, 'Silicone elastomers for airbag coatings', *Automotive Interiors International*, Winter 1996/7, 5(4), 66–71.
14. DuPont Automotive TI leaflets H-48030 and H 48032 (USA).
15. Siejack V (AKZO), 'New yarns for lighterweight airbag fabrics', *IMMFC*, Dornbirn, 17–19 September 1997.
16. Barnes JA, Partridge JF & Mukhopadhyay S, 'Air permeability of nylon 66 airbag fabrics', *Yarn and Fibre Conference*, Textile Institute, Manchester, 2–3 December 1996.
17. Insurance Institute for Highway Safety (Arlington, VA, USA), Safety Facts, Airbag Statistics, website <http://www.hwysafety.org/>
18. Ross HR (AlliedSignal), 'New future trends in airbag fabrics', *IMMFC*, Dornbirn, 17–19 September 1997. See also 'A technical discussion on airbag fabrics', StayGard™ nylon 6, Technical Information brochure, AlliedSignal, 1993.
19. Smith TL, 'Airbags and seat belts; fabric's role in safety restraint systems', *Automotive & Transportation Interiors*, December 1995, 53–4.
20. Lennox-Kerr P, 'Stichbonded airbags', (3M patent), *Nonwovens International*, July 1999, 37–8 – see also US Patent No. 5826905.
21. Braunstein J, 'Occupant safety/electronic supplement', *Automotive & Transportation Interiors*, June 1999, E1–10.
22. Wolff H, 'Problems with airbags – unneeded airbag firing is expensive and dangerous', *IMMFC*, Dornbirn, 15–17 September 1999.
23. Mowry G & Head A, 'Braided inflatable tubular structure technology in crash safety', *IMMFC*, Dornbirn, 15–17 September 1999.
24. Braunstein J, 'A steady march forward', *Automotive & Transportation Interiors*, December 1999, 32–41.

25. Braunstein J, 'Autoliv introduces one-piece weaving to North America', *Automotive & Transportation Interiors*, December 1999, 34.
26. Mukhopadhyay SK & Partridge JF, 'Automotive Textiles', *Textile Progress*, 29 (1/2), Manchester, The Textile Institute, 1999, 68–87.
27. Cheek M, 'Automotive carpets and fibres; an international perspective', *Textiles in Automotive Conference*, Greenville SC, October 1991.
28. Cox JH, 'Tufted carpet for auto use', *Automotive Textiles* (ed. M Ravnitsky), SAE PT-51, Warrendale, PA, SAE Inc., 1995, 145–50.
29. Creasy L, 'The great cover-up', *Automotive & Transportation Interiors*, August 1997, 16–22.
30. Zimmermann M (Rieter), 'Textiles for motor car interior fibres', *Technical Textiles*, 42 April 1999, E27.
31. 'Mouldable needlepunched nonwovens for auto applications', BASF Technical Information sheet TI/ED 1382, November 1988.
32. 'Binders for automotive interiors', Synthomer Technical Information. July 1996.
33. Laser J, 'Moulded automotive carpets – their influence on the interior noise', *Technical Textiles*, 41 February 1998, E4.
34. Schurian A, 'Computer-supported development of integrated carpet for cars', *IMMFC*, Dornbirn, 15–17 September 1999.
35. Souders SL, Doerer RP & Scott TE, 'Engineering, optimisation, and tuning of vehicle interior sound absorption and other mechanisms for sound reduction', *Automotive Textiles* (ed. M. Ravnitsky), SAE PT-51, Warrendale, PA, SAE Inc., 1995, 185–98.
36. Saha P & Baker RN, 'Sound adsorption study for auto carpet materials', *Automotive Textiles* (ed. M. Ravnitsky), SAE PT-51, Warrendale, PA, SAE Inc., 1995, 199–203.
37. Schuster D, 'New concepts for car trim parts to improve noise reduction', *IMMFC*, Dornbirn, 15–17 September 1999.
38. Braunstein J, 'The search for silence proves a never-ending quest', *Automotive & Transportation Interiors*, October 1995, 32–5.
39. Markel A, 'Sound judgement', *Inside Automotives International*, May 1998, 14–17.
40. Murphy J, 'The science of sound', *European Automotive Design*, Summer 1997, 30–3.
41. The sound of silence, Rieter Automotive Management brochure.
42. Anon, 'Feel the noise', *Automotive Interiors International*, October 1998, 48–50.
43. Anon, 'Silent partners', *Automotive Interiors International*, December 1998, 32–8.
44. Smith TL, 'Taking flock technology a step further'. *Automotive & Transportation Interiors*, February 1996.
45. Lebovitz R, 'Beyond flocking – new fibre technology battles the rattles', *Automotive & Transportation Interiors*, December 1995.
46. Ozsanlav V, 'Specific applications for jute/synthetic blends', *World Textile Congress*, Huddersfield, 15–16 July 1998, Huddersfield University, 1998.
47. Berthevas PR, Fanget A & Gatouillat G, 'The development of a sound insulation package for car floor coverings using a combination of polyurethane technologies', *J Coated Fabrics*, 18 October 1988, 124–41.

48. Anon, 'PU foams give selective sound damping', *BPR*, September 1997, 45.
49. Anon, 'EU applies pressure to reduce noise', *PRW*, 30 April 1999.
50. Bergmann L, 'Nonwovens for automotive filtration', *Technical Textiles*, 36 July/August 1993, E106-8.
51. MicronAir combi-Filters, Freudenberg information brochure D-69465.
52. Reinhardt H & Schuster M, 'Initial experience with electret microfiber filters in vehicle ventilation systems', ATA Congress, Bologna, October 14-16 1992.
53. Smith TL, 'Spunbond, meltblown nonwovens clear air between passengers, irritants', *Automotive Transportation Interiors*, August 1995, 34-5.
54. Borroff R, 'A breath of fresh air', *Automotive Interiors International*, February 1998, 34-7.
55. Anon, 'Electret nonwoven fabrics for special filtration applications', *Techtex Forum IV/90-1*, 4.
56. Markel AJ, 'Breathe easy', *Inside Automobiles International*, November 1998, 34-5.
57. 3M Cabin Air Filtration - 3M Innovation brochures, DW-0000-9537-3, and DW-0000-9538-3.
58. Kievit O & Klijn J (3M), 'In-car air quality enhancement by filtration', *IMMFC*, Dornbirn, 15-17 September 1999.
59. Mukhopadhyay SK & Partridge JF, 'Automotive Textiles', Textile Progress Series 29, (1/2), Manchester, The Textile Institute 1999, 86-96.
60. AlliedSignal website  
<http://www.alliedsignal.com/business/apg/products/filters.html>
61. Linden D, 'Batteries and fuel cells', *Electronic Engineers Handbook* (eds DG Fink & Christiansen), 3rd edn, New York, McGraw-Hill, 1995.
62. Bullock KR & Pierson JR (Johnson Controls), *Kirk Othmer Encyclopaedia of Chemical Technology*, Vol. 3, 4th edn, New York, John Wiley, 1992, 1083-103.
63. Anon, 'Japan's nonwoven industry (growth in battery separators)', *JTN*, October 1998, 15.
64. Marsh P, 'Electric vehicles', Battery Industry Survey, *Financial Times*, 10 May 1999.
65. Eisele D, 'Outer textile linings for cars - an innovation', *Technical Textiles*, 42 April 1999, E28-9.
66. Wohlgemuth J & Nordhoff R, 'Properties required of convertible top material as exemplified by the Mercedes-Benz CLK Cabriolet', *VDI Plastics & Textiles in Automotive Engineering Conference*, Mannheim, 25-6 March 1998.
67. Walkenhorst W, 'Dolan outdoor for soft top textiles', *IMMFC*, Dornbirn, 17-19 September 1997.
68. Bhakuni RS, Mowdood SK, Waddell WH, Rai IS & Knight DL, (Goodyear), 'Tires', *Encyclopaedia of Polymer Science and Technology*, Vol. 16, New York, John Wiley, 1989, 835-61.
69. Bhakuni RS, Chawla SK, Kim DK & Shuttleworth, 'Tire Cord', *Kirk Othmer Encyclopaedia of Chemical Technology*, 4th edn, Vol. 24, John Wiley, 1997, 161-86.
70. 'Tyres in the Environment', Environment Issues Series, Bristol, The Environment Agency, November 1998, 8-10 & 37-8.

71. Moncrieff RW, '*Man-Made Fibres*', 6th edn, London, Heywood, 1975, 266–70 & 394–8.
72. Anon, 'Business news', *TTi*, April 1998, 3.
73. Lambillotte BC, 'Fabric reinforcement for rubber', *J Coated Fabric*, 18 June 1989, 162–79.
74. Weber MO & Schilo D, (AKZO), 'Surface activation of polyester and aramids to improve adhesion', *J Coated Fabrics*, 26 October 1996, 131–6.
75. Janssen H, 'Aramid fibres and new adhesive systems to elastomers, applications and performance', 6th Annual Conference of Textile Coating and Laminating, Dusseldorf, 4–5 November 1996.
76. Anon, 'Short fibre Kevlar compound improves tyre performance' *Design Focus, BPR*, September 1997.
77. Fisher G, 'Prospects bright for rayon in tyre reinforcement', *TTi*, January/February 2000, 27.
78. Grace K, 'Polymers are crucial for the motor industry to meet its aspirations' *BPR*, November 1996, 26–30.
79. 'Kevlar and Nomex, reinforcement of automotive and industrial hose', Technical Information brochure L-10541 (1/99), DuPont, Geneva.
80. Leumer G & Gebauer E, 'Reinforcing solutions for hoses, belts and air springs', *TuT*, 20, 1996, 59–61.
81. Scott JR, 'Testing procedures and standards in rubber technology and manufacture', *Rubber Technology and Manufacture* (ed. CM Blow), London, Newnes-Butterworth, 1971, 446–77.
82. Smith LP, '*The Language of Rubber*', Oxford, Butterworth Heinemann with DuPont, 1993, many relevant pages.
83. Mukhopadhyay SK & Partridge JF, '*Automotive Textiles*', *Textile Progress*, 29 (1/2), Manchester, The Textile Institute, 1999, 97–107.

## 7.13 Further reading

1. Adanur S (ed.), '*Wellington, Sears Handbook of Industrial Textiles*', 6th edn, New York, Technomic, 1995, 495–522.
2. Blow CM (ed.), '*Rubber Technology and Manufacture*', London, Newnes-Butterworth, (for The Plastics and Rubber Institute), 1971.
3. Evans CW, '*Hose Technology*', London, Applied Science Publishers, 1979.
4. Monton M (American Chemical Soc), '*Rubber Technology*', New York, Van Nostrand-Reinhold, 1987.
5. Mukhopadhyay SK & Partridge JF, '*Automotive Textiles*', *Textile Progress*, 29 (1/2), Manchester, The Textile Institute, 1999.
6. Ravnitsky M (ed), '*Automotive Textiles*', SAE PT-51, Warrendale, PA, SAE Inc., 1995.
7. Rozelle WR, 'AlliedSignal; In the front seat with auto safety restraints' (seat belts/airbags), *Textile Month*, June 1995, 83–8.
8. Smith LP, '*The Language of Rubber*', Oxford, Butterworth Heinemann in association with DuPont, 1993.
9. 'Tyres in the Environment', Information booklet issued by the Environment Agency, November 1998.

10. Schumann OD (American Enca), 'Industrial Fabrics', *Man-Made Textile Encyclopaedia* (ed. JJ Press), New York, Interscience, 1959, 306–39.
11. Silvey DH & Rugman G (BF Goodrich), 'Belting', *Encyclopaedia of Polymer Science and Engineering* Vol 2, New York, John Wiley, 1985, 193–201.
12. Wake WW & Wootton DB, *Textile Reinforcement of Elastomers*, London & New Jersey, Applied Science Publishers, 1982.

## 8.1 Introduction

The car is a primary concern for environmentalists. It is high profile because of traffic fume pollution and the construction of roads from virgin countryside. There are in fact three main groups of environmental factors, which concern the car; manufacture, actual use, and problems regarding disposal. All three have significant effects on the environment and all concern textiles. The textile industry uses processes, which are potentially highly environmentally polluting, i.e. dyeing and finishing, lamination and other joining operations. As soon as the car is first driven from the showroom, it begins to emit polluting fumes and this continues throughout its working life. Efforts are being made to reduce this by catalytic converters and by other improvements. In addition the engine has been made more efficient so that it uses less fuel, and cars have become more aerodynamic and generally lighter in weight. Textile developments are contributing to the reduction of the weight of cars by the increased use of fibre composites, which replace heavier metal components. Recently approved EC legislation will require OEMs to be responsible for disposing of all scrap cars (end-of-life-cars or ELVs) by the year 2006, at no cost to the last owner. At least 85% of the material by weight of the car must be recycled with no more than 15% to go to landfill. By 2015, the figure will increase to 95 and 5% respectively. The metal components which make up about 75% of the weight of the car have always been recovered from old cars and recycled but the rest of the car is made up from many different classes of materials which, first need to be identified and then separated. These processes make disassembly time consuming and expensive, and therefore recycling of non-metallic components is generally uneconomical at present – but much is happening to change this, as will be discussed later.

Cars are now being designed from the beginning with disassembly in mind, and attempts are being made to use as few chemical types of plastic and types of fibre as possible to make recycling easier. In general, attempts

are being made to apply to the motor industry the environmentalist watch words of 'reduce, reuse, recycle'. However, this frequently entails extra cost, and government action or the threat of government action has been necessary in many cases, and is likely to continue to be necessary to ensure that certain procedures are carried out. Attitudes are changing, however, and there have been some very significant voluntary actions by the industry as a whole and by certain OEMs as will be seen later in the chapter. Less than a decade ago sales personnel advised that being 'green' does not sell cars, but as time passes it is gradually being regarded as being a marketing tool. Companies now want to appear environmentally friendly and socially responsible. They are in agreement with the principle of 'sustainable development' which can be described as the objective of meeting the needs of the present without compromising the ability of future generations to meet their own needs. This term was first introduced in the Brundtland Report, '*Our Common Future*' in 1987, which was produced by a World Commission on Environment and Development. Both the EU and the UK government have published reports defining their interpretation and their strategies for achieving it.

Many industrial organizations now issue annual environmental reports and are ISO 14001-accredited or are working towards it. The general public world-wide is now aware of, and concerned about the vital environmental issues facing humanity as a whole. Evidence of this, is the existence of over 2600 environmental organizations in more than 200 countries of the world. The car is a symbol of affluence for both the developed and developing world and car ownership is steadily increasing, but rises in living standards in general produce more pollution as summarized by Meadows and his co-workers<sup>1</sup> in the equation; –

$$\text{Impact on environment} = \text{Population} \times \text{Affluence} \times \text{Technology.}$$

All three dependent factors are increasing and without drastic action an environmental disaster seems inevitable. However, much is being done by the EU, the United Nations and by governments of the world. This chapter discusses the issues and describes the various attempts which are being made to produce a more environmentally friendly car.

## 8.2 The greenhouse effect and global warming

Human life depends on the 'greenhouse effect', which is caused by the presence of a number of certain gases and water vapour in the atmosphere. The surface of the Earth would actually be about 30°C lower than normal if they were absent. Small changes in their concentration cause small changes in the surface temperature of the Earth, and it is believed the whole ecology of the world could be changed by small variations. This is a very delicate

balance because increases in surface temperature by only one degree C are thought likely to cause very significant changes in world climate and sea water levels.

The greenhouse effect happens because heat is retained by the Earth's atmosphere and surface, see Fig. 8.1. The atmosphere as a whole, including greenhouse gases, allows sunshine, made up of both short and longer wavelength radiation to pass through to heat the Earth's surface. The warm earth then radiates heat back, but this new radiation is at a longer wavelength, which cannot pass back outward through the greenhouse gases to outer space. Instead the greenhouse gases are heated up by this radiation energy, giving rise to global warming. The main greenhouse gases are carbon dioxide, methane, nitrous oxide, ozone and CFCs (fluorine compounds used in aerosol sprays and refrigeration). Particulate matter also contributes to global warming. Apart from CFCs which have been phased out in the developed world, all these substances are associated with use of the car, and also disposal of the car.

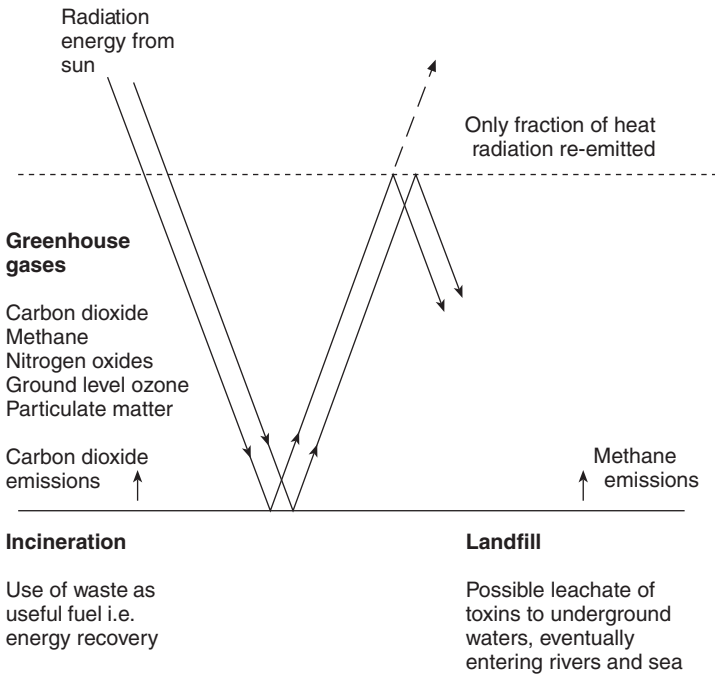

8.1 The 'greenhouse effect'.

The amount of carbon dioxide in the atmosphere is increasing at the rate of about 0.5% every year and motor vehicles are responsible for 15% of the world's total carbon dioxide emissions. Research shows that since the middle of the last century increased amounts of greenhouse gases have raised the average global temperature by about 0.5°C. If greenhouse gas levels continue to increase at the rate expected, a further warming of about 1.5°C within the next 40 years could be caused<sup>2</sup> with serious effects on global climate. Global warming, in reality excess global warming, is therefore the concern of every nation on the Earth. This was the main subject for the meetings of world leaders from 160 countries at Rio de Janeiro in 1992. At the second meeting at Kyoto in 1997 the general target was set for developed nations to reduce their greenhouse gas emissions by 5% below 1990 levels by the years 2008–2012.<sup>3</sup> Within the same time frame the EU was committed to reduce emissions of six greenhouse gases by 8%, the UK agreed to reduce its emissions by 12.5%. This has special importance for the auto industry because car populations are predicted to increase substantially in the next decade. Although carbon dioxide is the chief greenhouse gas, methane, nitrous oxide and ozone in fact have a far greater effect than would be expected from their relatively low concentration.<sup>4</sup>

The same 'greenhouse effect' is the reason for the very hot temperatures inside cars in sunny weather. In this case the window glass acts as the 'greenhouse' increasing the temperature of the car interior.

## **8.3 Environmental legislation**

### 8.3.1 Introduction

United Kingdom environmental legislation relates to air, water, land and noise pollution – although the latter does not directly concern this book. The earliest environmental laws are believed to have been passed during the thirteenth century controlling the burning of coal. However, times change and accepted standards become more demanding with the increase in the quality of life. Environmental regulations have therefore become stricter and more wide ranging to meet new circumstances. In addition to UK law there are now EU environmental laws in place. EU legislation take the form of directives and regulations. Directives are guidelines to be used by individual countries to form their own laws, whereas regulations are themselves legislative acts which apply across the EU without further action by individual countries. The EU in 1973 (then called the EEC) started the mechanism for programmes of action on the environment to reduce pollution and nuisances, to tackle environmental problems caused by depletion of natural resources, to promote awareness of environmental problems and education and also to improve the natural and urban environment. Since

this date the EU has been one of the leaders in the world community in protecting the environment. The EU publish guidelines for air quality in Europe, based on World Health Organization information.

There are also United Nations environmental initiatives, through their Environmental Programme (UNEP – founded 1973), to which the UK and other EU countries have agreed. These include the Montreal Protocol in 1987 to protect the ozone layer and the decisions taken at the ‘earth summits’ at Rio de Janeiro and Kyoto on carbon dioxide emissions and global warming. The UN was also instrumental in the Convention in long-range transboundary air pollution adopted in Geneva during 1979 which came into force in 1983 to reduce transboundary air pollution over Europe and North America. The main concern at the time was acid rain over Scandinavia, but the Convention now also targets other pollutants including heavy metals and volatile organic compounds (VOCs).

In addition to EU and UN initiatives, there have been, since 1984, meetings of countries which border the North Sea to discuss steps to reduce the build-up of toxic chemicals and other pollutants in this area.<sup>5</sup> Measures agreed at the Third North Sea Conference, to cut levels of a number of specific chemicals and to treat sewage more effectively before discharge became legally binding. Switzerland, which has industries along the Rhine which flows into the North Sea, attended this conference.

### 8.3.2 United Kingdom laws

In recent times a succession of new laws has been implemented which update, but not always completely replace earlier ones. Thus a process may be governed by a series of laws applying to different aspects. During the 1970s and 1980s there was a sharp increase in public awareness of environmental concerns and this has been reflected in increasingly tight legislation. The 1974 Control of Pollution Act was one of the most important laws passed in this area although key aspects covering effluent discharges only came into force during 1985.

#### 8.3.2.1 *Water Act 1989; Water Acts 1991*

The National Rivers Authority (NRA) was created by the 1989 Water Act to take over the regulatory duties of the individual water companies which were then privatised. This new body tightened up on existing regulations and added further restrictions and set up mechanisms to monitor and control effluent discharges into inland surface waters, estuaries, coastal waters and also underground waters. Clearly defined and absolute limits were set for pollutants together with other actions to implement their new regulations including the requirement of a named manager responsible for

effluent control in each organisation.<sup>6</sup> Much of the 1989 Act was re-enacted by the Water Resources Act and the Water Industry Act which were passed together with three other Water Acts in 1991 with the purpose of consolidating all the previous legislation involving water. The Water Acts formalized the principle of 'the polluter pays', which, in fact, was a condition of the Treaty of Rome but was first mentioned at a UN conference on the Human Environment in Stockholm in 1972. The NRA has also implemented European laws and the decisions of the North Sea conferences which called for reductions in discharges of a large number of specified chemicals which included, cadmium, mercury, lead, chloro-organics and some textile chemicals.

### 8.3.2.2 *Environmental Protection Act*

The Environmental Protection Act (EPA) was placed on the Statute Book during November 1990. This act set up an industrial pollution control system which included 'Integrated Pollution Control' (IPC) for the 5000 most potentially polluting industrial factories. The act applied to all major solid, liquid and gaseous emissions to land, waters and air. A timetable for gradual implementation was drawn up which began on 1 April 1992 with the fuel and power industries and progressed through to November 1995 when it was extended to all other industries which included textiles. Her Majesty's Inspectorate of Pollution (HMIP) ran IPC and all existing operators had to register and were generally given between 3 to 8 years to bring their plant up to the new required standards or face closure. After January 1991 all new processes prescribed for IPC had to register immediately for authorization. This applied also to significantly modified processes.

Air Pollution Control (APC) also became law within the 1990 EPA act to control smaller scale polluters which were to be regulated by local authorities. Industries such as textile finishing, coating and lamination and solvent-joining operations generally came under this category. Thus the EPA was implemented by two mechanisms; IPC controlled by HMIP for large scale polluters which had national implications (so-called Part A), and APC for smaller polluters regulated by local authorities so any relevant local factors could be taken into consideration (so-called Part B). Both systems applied the same regulations and used the same guidance notes.

### 8.3.2.3 *BATNEEC*

Applicants for authorization for a process had to be able to show that attempts had been made to prevent or minimize emissions or to render them harmless using the 'best available techniques which do not entail excessive cost' (BATNEEC). These regulations applied to both Part A and

Part B processes and to all aspects of the operation including design, staff training and qualifications, operating procedures and emission levels. The interpretation of BATNEEC however needs careful consideration.<sup>7</sup> Each word is open to qualification and definition depending on individual circumstances and merits. If the cost of the best available technique is considered to outweigh the environmental benefit this will be taken into account. HMIP has drawn up technical notes for the Part A processes and the Department of the Environment and Local Authority concerned drew up the notes for the Part B processes. These notes include abatement technologies, monitoring techniques, storage, handling aspects and emission controls.

#### 8.3.2.4 *The environmental agencies*

The 1995 Environmental Act established the Environmental Agency in England and Wales (EA) and the Scottish Environmental Protection Agency in Scotland (SEPA). From April 1996 the new agencies were made responsible for waste regulation and control of water pollution by combining the activities of Her Majesty's Inspectorate of Pollution, the National Rivers Authority, some agencies of the Department of the Environment and the local authorities' waste regulation authorities (WRAs) which were responsible for regulating the handling and disposal of waste. The objective of this reorganization into a single agency was to simplify matters for industry and to produce more effective control. The new Environmental Agency is responsible for air and water monitoring and advises the government on environmental standards and the means necessary to ensure that they are met. However some responsibility for air pollution control remains with local authorities. Under the Air Quality Regulations of 1997, they have a duty to manage air quality in their own areas which includes monitoring, modelling and establishment of emissions data bases.<sup>8</sup>

### 8.3.3 European legislation

The EU since the early 1970s when it first adopted a formal environmental policy has passed well over 200 laws and further impetus was applied by the 1987 Single European Act. This demands that full account of the environment and of the principle of sustainable growth is taken into account when proposals in all areas of Community policy are put forward for legislation. A European environmental Agency has been set up in Copenhagen to provide independent, reliable, objective and comparative information on the state of Europe's environment. This unit will publish periodic reports on the state of the environment and is examining a range of issues including air quality and nature conservation. The agency is unusual for an EU

institution because it includes some non-member countries such as Norway and Switzerland.

### 8.3.3.1 *European IPPC*

The European Integrated Pollution Prevention and Control Directive (IPPC), based on Part 1 of the UK Environmental Protection Act 1990, concerns major industrial operators who are to be licensed in an integrated way to control emissions to the air and water and to manage waste to protect the environment as a whole. In addition IPPC is also concerned with the use and nature of raw materials including water, energy efficiency, prevention of accidents, low waste technology, noise and also restoration of a factory site to a satisfactory condition when production ceases. The overall concept is to make industry aware of the process as a whole and to adopt clean technology throughout. This EC Directive of 1996 will apply to all new installations within the European Union by October 1999 and to all existing installations by October 2007. It is broader in scope than IPC, and in the UK by the year 2007, there are expected to be 5000 major sites which will be affected – some of which fell outside the scope of the EPA.<sup>9</sup> The conditions of licensing will ensure that there will be no breach of EU environmental quality standards or laws and that high standards of environmental protection will be applied to protect the environment as a whole using the best available techniques. The monitoring will need to be done by an independent test laboratory to CEN Standard 45001.

### 8.3.3.2 *Air quality*

Deteriorating urban air quality is one of Europe's two major environmental problems (the other is agriculture) and further Directives from Brussels are expected. One expected to be in place by the year 2000 seeks to cut emissions of petrol-engined vehicles by up to 40% and halve the emissions of diesel engines.<sup>10</sup> There are also plans to reduce sulphur content of fuels and other measures aimed at control of car exhaust emissions.

The European parliament is also processing a directive by which member states will be required to have national reduction plans for volatile organic compounds (VOC). The objective is to reduce VOC emissions by 66.6% when compared with 1990 levels. This measure is likely to affect those factories which use solvent-based adhesives on a large scale. There have however been very significant contributions to clean air by voluntary actions, which have also produced cost savings. An example is the reduction of VOCs from paint spraying by careful management and use of new technology at Vauxhall's Ellesmere Port factory, which has also cut their electricity bill by 6%. Another example is Fords at Halewood who have

reduced VOC emission by 40% and saved £60000 on chemicals and waste disposal in the process.<sup>11</sup>

In the UK, air quality in the general public environment is monitored for the main pollutant gases, lead and particulate matter, PM 10 at various urban sites. This is co-ordinated by the National Environmental Technology Centre under EU regulations and reports are available on Freephone 0800 556677 (in the UK), on levels of nitrogen dioxide, sulphur dioxide, ozone, benzene, 1,3 butadiene, carbon monoxide and also particulate matter. Under the Environmental Act 1995, air quality standards were set in the National Air Quality Strategy and local authorities will be responsible for ensuring that the levels set are not exceeded in their area after the year 2005.

### 8.3.3.3 *Landfill*

In the UK at present about 25% by weight of the car goes to landfill with about 75%, mainly metal being recycled. Proposed European Directive DGX1 (Environment) will require by 2005, no more than 15% to go to landfill. This will decrease to 5% by the year 2015, with at least 85% being recycled. It is proposed that 10% may be incinerated with energy recovery. A European Landfill Directive, close to becoming law will prohibit disposal of whole tyres by landfill in 2002 and shredded tyres in 2005.<sup>12</sup> Every year some 350000 to 400000 tonnes of scrap tyres must be disposed of. Landfill is generally recognized as the least attractive option for a number of reasons. There are the risks of toxic chemicals entering water-courses and the formation of methane, a greenhouse gas with the added possibilities of explosions and uncontrollable fires. EU 1998 landfill directives will reduce the amount of waste disposed of in this way. In the UK, using 1995 levels as the baseline, biodegradable waste must be reduced to 75% by 2010, to 50% by 2013 and to 35% by 2020.<sup>13</sup> Landfill charges are increasing in many countries of the EU. In the UK at present, waste classed as 'inactive', e.g. bricks, concrete or glass is charged at £2 per tonne, while all other waste that decays is charged at £7 per tonne. All landfill operators in the UK must now be licensed by the Customs and Excise.

### 8.3.4 United States legislation

The situation in the USA has followed a generally similar pattern to the UK with much environmental legislative activity and public concern from about the 1970s onward.<sup>14,15</sup> Major acts and amendments have included, environmental protection acts of 1970, 1980 and 1995, the Clean Air Acts of 1977 and 1990, Pollution Prevention Act of 1990 and Clean Water Act of

1987. There has also been special emphasis on control of insecticides, fungicides and rodenticides with an act passed in 1988. Public concern has also been influenced by international scale disasters such as Bhopal, Chernobyl and the Exxon Valdez oil spillage.

## **8.4 The effects of pollutants**

### **8.4.1 Air pollution (exhaust fumes)**

Air pollution is caused by harmful gases or vapours and solid particulate matter. There are many air polluting gases which are harmful to human, animal and plant life but the main ones are; oxides of sulphur, carbon monoxide, hydrocarbons and oxides of nitrogen.<sup>16-18</sup> The last three are present in significant concentrations in car exhaust fumes. Sulphur additives along with lead additives are being phased out of petrol and diesel in the UK and in other developed nations of the world. Particulate matter is also present in car exhaust fumes, especially those with diesel engines. Since the beginning of 1993 all new cars within the EU have had to comply with strict regulations on emissions. The catalytic converter has reduced pollution but is not yet a standard item on every single car. Oxides of sulphur, produced mainly from industrial burning of fossil fuels gives rise to acid rain which is harmful to human health and also damaging to agricultural crops, vegetation and materials including buildings. Oxides of nitrogen contribute to acid rain and produce adverse physiological conditions including eye and throat irritation if present in high concentration. Carbon monoxide is toxic to human and animal life because it combines with haemoglobin in the blood resulting in less oxygen being carried to body organs, heart patients being especially vulnerable. Hydrocarbons and oxides of nitrogen are the main constituents of traffic smog and under the action of sunlight they produce ozone, which is an eye and throat irritant. Their ability to create ozone is measured by their photochemical ozone creation potential (POCD). This ozone should not be confused with the UV filtering ozone layer, which is several miles above the earth's surface. One of the hydrocarbons present in exhaust car gases is benzene, which is a carcinogen and is believed to contribute to anaemia. In addition all combustion processes involving organic compounds produce carbon dioxide, the chief greenhouse gas.

### **8.4.2 Particulate matter**

Particulate matter comprises many different substances, although it is mainly soot (carbon). It is present in a wide range of particle size but the

most harmful to human health are the particles, smaller than 10 microns in diameter.<sup>19,20</sup> These particles do not settle rapidly on the ground as dust but are present for long periods in the air and are therefore more available for breathing into the human body. The American Environmental Protection Agency classified these particles as PM10s (particle matter less than 10 microns), and PM10 pollution is the total weight in microgrammes of all particle matter of 10 microns in diameter or less contained in one cubic metre of air. In the USA the legal limit is 50µg of PM10 per cubic metre of air as an average in a year.<sup>19</sup> Many cities of the world have peak PM10 values of 100 to 200. Particle size is important because particles larger than 10 microns usually get no further than the nose or throat. Particles smaller than 5 microns can enter the bronchial tubes at the top of the lungs but the smallest, 2.5 microns and less can penetrate into the deepest, (alveolar) lung tissue where gas exchange occurs between the air and blood. If soluble the particle matter enters the blood stream, if not particles can remain in place for months or years. Particle matter is believed to be the cause of bronchitis, asthma, other chest and breathing conditions and contributing to lung cancer. In the UK motor vehicles are responsible for 26% of PM10 particulate matter.<sup>21</sup>

### 8.4.3 Land and water

Pollution of waters by the textile automotive industry is mainly caused by manufacturing processes such as dyeing and finishing. Toxic liquors will harm marine life and could be harmful to humans on beaches. Pollutants are broken down chemically and biologically in the water, but both mechanisms require action by the dissolved oxygen in the water. This reduces the amount of dissolved oxygen in the water available for survival of fish and other marine life. Measures of these effects are the oxygen demand indices, BOD – biological oxygen demand and COD – carbon oxygen demand.

Disposal of industrial waste by landfill is one of the least attractive options because of the potential problems, not to mention the appearance of such sites. Decay of organic substances can result in the formation of methane gas which not only carries the risk of explosion, but also contributes to global warming. In addition toxic materials and heavy metals may at some time in the future pollute underground waters which may in turn contaminate rivers and even drinking waters. Heavy metals such as lead and mercury accumulate in the body until present in sufficient quantity to act as poisons. Lead is believed to cause damage to the brain and to the central nervous system, mercury also affects the central nervous system, whilst cadmium is believed to produce bone conditions.<sup>22,23</sup>

## 8.5 Manufacturing concerns

In common with most major industries, automotive and textile producers take environmental and health and safety issues very seriously. Environmental policies and environmental management systems have been established by all major manufacturers. BS 7750 issued in 1992 was designed to enable industry to establish effective environmental management systems for sound environmental performance, for participation in environmental auditing procedures and for management reviews. This standard had links with the quality management standard systems BS 5750 and was also consistent with the then draft EC regulation to set up voluntary schemes for environmental management, which became known as the Environmental Management Audit Scheme (EMAS). Four years later the first of the ISO 14000 series were published by the Swiss based International Organization for Standardization, which draws from 111 countries. ISO 14000 is a group of voluntary international standards, which have the objective of providing consistent and effective environmental management system for all operational procedures. ISO 4001 is the first of some 20 separate standards, which cover all issues from environmental auditing to the assessment of life cycles of products. ISO 4001 requires identification of environmental aspects, policy and objectives and a commitment to comply with all relevant legislation and regulations.<sup>24,25</sup>

### 8.5.1 Wet processing

Textile processes attempt to use the minimum amount of water for economic as well as for environmental considerations. The textile manufacturing industry is potentially environmentally polluting in two ways; discharge of effluent from wet processing and air emissions from stentering, finishing, fabric coating and lamination. Both are now very carefully controlled by the environmental pollution laws which have become progressively stricter in recent years; informative articles have appeared in trade journals.<sup>6,26-29</sup> Manufacturers may not discharge trade effluent into a public sewer without authorization from the local water authority. The application form for permission should include details of the effluent, chemicals, suspended solid matter, biological content etc. and information on the amount to be discharged in a day including the peak rate of discharge. In April 1989 a list of 23 chemicals which were to be subject to stricter control was announced by the government, the so called 'red list'. These chemicals were already on the EC 'black list' and are now subject to control under BATNEEC to minimize inputs into the environment. The 'red' list includes mercury and its compounds and cadmium and its compounds. Discharge levels are also subject to agreements reached in North Sea Conferences, especially the

Third in 1990 and the Fourth in 1995 at which there were further commitments to reductions.

The environmental effects of textile chemicals have come under scrutiny and certain chemical types have had to be replaced with more environmentally friendly ones. Certain anionic sulphonates with branched molecular chains which are not biodegradable are being replaced by straight chain types which can be broken down by bacteria in the effluent plant. Also certain phosphate chemicals which support algae growth in rivers and waters are being phased out. The algae 'blooms' are harmful to both plant and marine life by blocking out sunlight and reducing the oxygen content of the water. The chemical manufacturers have been very active and can supply much useful information. Discharge of coloured dyeliquors to sewers was once one of the most common infringements but now this seldom happens. There are a whole variety of ways of removing colour from effluent including use of membranes, activated carbon, inorganic adsorbers, ozone, coagulation/flocculation and the latest biological methods.<sup>30-35</sup> All work reasonably well, the main limiting factors being the speed of colour removal and capital cost, but some of the colour-removal processes themselves present disposal problems, i.e. membranes. Any damage to the environment caused by harmful discharges must be made good and the bill sent to the offender under the 'polluter pays' principle.

There are also restrictions on pH and temperature of effluent discharges which mean that provision must be made for alkali-dyeing techniques and dropping the high-temperature dyebaths to minimize oligomer in polyester dyeing. The rate of discharge and peak disposal rates must be notified to the local authority. The discharge of prescribed substances such as mercury and its compounds, cadmium and its compounds, and certain organic compounds is very severely restricted. Consent levels are agreed with the local water company under conditions set by the Environment Agency who also set monitoring levels procedures. Process Guidance notes (PG series) are available from the DETR through HMSO.

Lubricant content of loomstate or unfinished fabrics can sometimes be up to 2% by weight and much of this 'oil' is removed during scouring and stentering. Most fabric however is now scoured and spent liquors should be treated before discharge to drains, with pH, temperature and solid content being the usual factors requiring attention. All stenter fumes should be abated before discharge to atmosphere and the emissions should be monitored regularly in accordance with standards arranged with the Environmental Agency. Coatings applied to automotive fabrics are now invariably water-based and the material driven off during processing is mainly water but there may be organic chemicals, which have to be removed before the emissions are released to atmosphere. Guidance Notes relating to air

quality (AQ series) have been prepared by the DETR and are available from HMSO.

### 8.5.2 Lamination and joining

Joining methods using solvent-based adhesive spray application methods and flame lamination are potentially highly polluting but are now very carefully controlled.<sup>36,37</sup> Many solvent-based adhesives have been replaced and continue to be replaced with hot-melt, high solids content and water-based varieties. However joining with solvent-based adhesives is still widespread. In the fabric-coating industry, water-based resins are used whenever possible but in some cases it is proving difficult at present to obtain the high standards of performance and durability normally achieved with solvent-based types. However, as stated above, solvent use is to be subject to closer restrictions, and targets have been set by the EC to reduce VOC emissions by 66% compared to 1990 levels with a compliance date of 2007.

Flame lamination fumes are monitored and must be treated by very effective methods, if necessary by the carbon adsorption techniques. Under the Environment Protection Act 1990 and the Environment Protection (Prescribed Processes and Substances) Regulations 1991 Di-isocyanate Processes, operators of potentially polluting industrial plant must be registered with the Environmental Agency before beginning production and must regularly monitor levels of potentially harmful substances. Guidance notes for operators are available from government book-shops, the relevant pamphlet for flame laminators is IPR6/5, entitled 'Toluene di-isocyanate use and flame bonding of polyurethanes'.

### 8.5.3 Health and safety aspects

#### 8.5.3.1 *Control of hazardous substances*

In addition of course, all chemicals and materials used in the textile and automotive industries are subject to the Control of Substances Hazardous to Health regulations (COSHH) of 1994 (which replaced the original 1988 regulations) and March 1999, which cover, all aspects of purchase, handling, transportation, storage, use and disposal. The most important issue is that an employer cannot carry out any activity, which exposes employees to any hazardous substance unless a 'suitable and sufficient' assessment has first been made. The assessment must be reviewed regularly and whenever any significant modification to the process has been made. Hazardous material may include gases, vapours, liquids, fumes, dusts, solids or micro-organisms and when stored or transported are also subject to the Classification,

Packaging and Labelling of Dangerous Substances Regulations of 1984. Guidance notes on safe handling, maximum exposure limits, occupational exposure limits and monitoring strategies, are regularly updated and are available from the Health and Safety Executive.

Manufacturers and suppliers must supply documented information on chemicals, adhesives and other raw materials in material safety data sheets. These documents contain information on chemical composition, physical and chemical properties, toxicological and ecological aspects, potential hazards with first aid measures, storage and transport, protective clothing and other controls necessary for safe handling and disposal. They should conform in format and content to EC Directive 91/155/EEC. EU regulations have generally tightened control of potentially harmful chemicals.<sup>38</sup>

#### 8.5.3.2 *Hazardous material content*

Some customers are now concerned with the presence of potentially toxic chemicals in car interior trim components and an increasing number now require information on this. Hazardous material assessment forms are issued which list chemicals such as lead, nickel, cadmium, mercury, certain organic chemicals including bromine, etc. and the usage in the manufacturing process or concentration, in parts per million in the finished article must be declared. There are halogen and phosphorus flame-retardant chemicals in some flame-retardant qualities of both fabric and polyurethane foam. Although the risk to health from this source is likely to be quite low compared with similar chemicals in some apparel or even domestic furniture, consumer concern must be taken seriously. Considerable effort has been made by the chemical industry to replace these materials but so far with limited success. Higher concentrations of alternative chemicals are required to produce the same performance. However, the situation is not yet clearly resolved especially because bromine compounds have been found in the marine environment and in mammals.<sup>39,40</sup> Some researchers however believe that the benefits of flame retardants outweigh the risks to human health and the environment.<sup>41-43</sup>

#### 8.5.3.3 *PVC*

The use of PVC has been questioned by some environmentalists and pressure groups, especially because of the possible formation of dioxin chemicals during its manufacture and eventual disposal.<sup>44</sup> Certain OEMs, notably BMW are reducing or have discontinued the use of PVC in cars, although others still use significant amounts. Amendments to draft proposals to an ELV EU Directive which would have reduced or phased out the use of PVC in EU-built cars were defeated in the European Parliament.<sup>45</sup>

#### 8.5.3.4 *Eco-labelling*

In a strict interpretation of the term, ecolabels are applied to consumer goods as an indication that the product has been manufactured under environmentally friendly conditions, from environmentally friendly materials and will not pose any threat to human health or to the environment during its useful life nor at disposal. This process is a life-cycle analysis, also called a 'cradle to grave' approach but in practice is almost open-ended for many products and at best is extremely costly and time consuming to carry out. However this has been the basis of the EU ecolabel, which started with only a limited number of products including T-shirts and bedlinen. There have been recommendations for simpler procedures, which concentrate on the more important characteristics of products. There are several ecolabels in Europe such as the 'Blue Angel' in Germany and 'White Swan' in Scandinavian countries and in the USA there is the 'Green Seal'. Some of these labels are based on environmental audits of the manufacturing process alone such as energy efficiency. Others are based on assessments of the content of hazardous material.<sup>46-48</sup> Such a label is the Oko (or Oeko)-Tex Label run by the International Association for Research and Testing in the Field of Textile Ecology, which includes the Hohenstein Institute in Germany and BTTG in England.<sup>49</sup> To obtain an Oko-label, textile products are analysed for content of a range of potentially hazardous chemicals such as cadmium and mercury and a label given if they are absent or below defined levels. Another example is the Toxproof mark offered by TUV Rheinland, Cologne, which is issued to textile goods only after they have been tested to TUV criteria which includes heavy metals, chlorinated phenols etc. Eco-labelling is believed to encourage competition for environmental innovation but as yet there seem to have been few efforts to apply them to the automotive industry. It has been suggested that they be applied to public transport!

## 8.6 Sustainable development

### 8.6.1 Recycling of interior trim

Throughout Europe there are about 12 million ELVs disposed of every year and this is increasing at the rate of about 3% per year. The metal parts are recycled but the remainder, about 25% by weight of tyres, glass and an assortment of plastics, textiles and other materials loosely termed 'shredder waste' from automobile shredder waste, ASR (sometimes called 'crusher' waste – ACR), mostly goes to landfill at present. Car seats and other interior items are included in this ASR posing serious challenges for the industry which will become more pressing as the deadlines for reduced

landfill approach. OEMs are supporting schemes to identify and sort scrap material. Most of the major OEMs are also making efforts to increase the recycled material content of their cars and certain OEMs are making recycling a key design consideration, specifying that parts supplied must be made from a certain percentage of post-consumer recycled material.<sup>50-52</sup> From press reports, Fords appear to be especially energetic in this exercise and are putting pressure on their suppliers. Eventually Fords want to attain 90% vehicle recyclability (by weight), whereas others such as Daimler Chrysler want to do even better – 95% by the year 2005.<sup>53</sup> The EU legislation mentioned earlier, will require a system of collection – at no cost to the last owner, and disassembly to be created for re-use, recovery and recycling at the end of the vehicle's life. An amendment stated 'producers must meet all, or a significant part of the costs'. OEMs hope that this leaves some room for negotiation as to actually who, in the industry will pay. A previous draft stated that the responsibility will rest with the automotive sector's 'economic operators', which was interpreted as every commercial organization involved with vehicles and not only the OEM. The cost of course, will ultimately be passed on to the consumer. Needless to say, the European car industry considers these measures unreasonable because the car is already 75% recycled by weight and actual waste from cars, the industry claims, represents only 0.2% of all European industrial waste.<sup>54</sup> In addition since 1997 there have been voluntary agreements within the industry to improve the car's environmental impact (see below). However, the EU considers ELVs a priority and these measures are very likely to affect the textile industry eventually because fabric and fabric laminates are major interior components of motor vehicles. The passing of the directive which will have serious financial implications for OEMs was by pressure from the automotive industry, especially in Germany.<sup>55-57</sup> Automotive industry spokesmen have claimed that the new law is 'too heavy a burden' and that in practice, it encourages the production of heavy cars using more metal – if the ELV directive had already been passed, the 3 litre car could not have been developed. The 3 litre car uses three litres of petrol to cover 100 kilometres i.e. 92 m.p.g. and contains a high proportion of weight saving plastic material. Recycling analyses of automotive plastic and textiles have been carried out.<sup>58-60</sup>

### 8.6.2 Fabric recycling

The car seat laminate is generally made up from polyester face fabric, polyurethane foam and a scrim fabric which is either nylon or polyester. These chemically dissimilar materials are not easily separated and therefore cannot be easily recycled. The use of polyester scrim reduces the number of chemical types to two but even this presents a problem. Chem-

ical hydrolysis can be used to break down the three polymers into simpler chemicals which can be used as fresh raw materials, but at present this is not commercially feasible,<sup>59</sup> although much work has been carried out and reported,<sup>61-70</sup> several different types of non-woven and knitted fabric have been evaluated as substitutes for laminate polyurethane foam including the 'spacer fabric', Kunit, Multinit and wool/polyester blended fleece made from recycled garment waste. Some are being used commercially in German-made cars. These foam substitutes do not need a scrim backing and those in polyester together with a polyester face fabric produce a seat cover laminate all in one polymer type.

Some polyester fibre manufacturers, Hoechst and EMS have demonstrated the possibility of running recycled polyester face fabric into non-woven material. Shredded face fabric is mixed with 30% of virgin polyester polymer, melted and re-extruded into a non-woven fibre which although discoloured can be used as the foam substitute in a new seat cover. When this seat cover comes to the end of its life it can be shredded, melted and extruded again but this time with a higher proportion of virgin polymer to compensate for the used polyester being recycled a second time. Alternatively it can be used in a less demanding end-use. Thus the same polymer is reused but each time in a progressively lower specification application. Non-woven polyester spun from recycled polyester bottles by Wellman is currently being used in some production models. Bottle manufacturers continue to develop and improve polyester bottles for many other end-uses and there could soon be a surplus of polyester bottles available for recycling. However 'closed loop' recycling is generally recognised as the most satisfactory recycling procedure. This is when the recycled material, in the present context, automotive interior trim fabric is recycled back into the original end-use, i.e. back into an automotive textile.

### 8.6.3 Recycling of polyurethane foam

The manufacturers of polyurethane throughout the world have responded to the challenges of the environment and pointed out the ways in which waste polyurethane foam can be reused and recycled or disposed of with minimum effect on the environment.<sup>72-74</sup> The methods involve shredding into crumbs and smaller particles and reprocessing them by compression moulding, adhesive rebonding or thermoplastic rebonding into useful articles including backings for carpets, rugs and other items, making use of the acoustic and shock-absorbing properties. Polyurethane foams have been ground into powder and added into new compound mixes as filler. Studies have been carried out on the feasibility of chemolysis, breaking the material down chemically into the original raw materials for use in existing or new products. Composting and incineration as a useful fuel to recover the

energy have also been considered. The Polyurethanes Recycle and Recovery Council (PURRC) of the (American) Society of the Plastics Industry, made up from 14 major manufacturers was set up as early as 1990 and have worked to tackle the problem of both process and post-consumer waste. In the USA there is a market for foam for recycling into new products such as carpet backing. The European Isocyanate Producers' Association (ISOPA) provides a focus for the environmental responsibilities of the polyurethane industry and has issued a series of comprehensive technical information sheets on recycling possibilities for polyurethane foam.<sup>75</sup>

Seat makers have carried out work to explore using ground-up foam from car seats as filler for virgin foam in new car seats. Physical properties are reduced in quality but may be satisfactory in use. However, the problem of interior trim foam being joined to other materials and the high cost of dismantling and handling remain. Foam processing waste in fabric lamination plants, however, are taken back by certain manufacturers for reprocessing or reuse.

#### 8.6.4 Logistics of automobile recycling

The first step in the recycling process is collection of the ELV. A single scrap car has little value to its last user and occasionally abandoned cars are seen littering the landscape. These are not only an eyesore but also constitute a health and safety hazard. About 8 million ELVs are scrapped each year in the EU. With a certain amount of pressure from governments, voluntary accords have been set up since the early 1990s in different countries, amongst them were the Automotive Consortium on Recycling and Disposal (ACORD) in the UK, PRAVDA in Germany, and the Environmental Car Recycling in Scandinavia (ECRIS).<sup>76-78</sup> They were set up to provide national frameworks for economic break-even for recovery systems, to reduce waste disposal from ELVs and to ensure that all are properly collected.

The Association des Constructeurs Europeens d'Automobiles (ACEA), in Brussels promotes research to improve the design of vehicles for ease of disassembly and also selection of materials to aid recycling and to minimize material which cannot be recycled. The Consortium for Recycling (CARE) was established in the UK in 1996.<sup>79</sup> CARE is made up from ten OEMs and a number of car dismantlers and works with government bodies and other organisations to produce specific results from practical work by helping individual companies. Recytex, previously a subsidiary of Viktor Achter, the car upholstery manufacturer has processed textile waste from its parent company and others since 1993. Recently Recytex has been co-operating with Mercedes-Benz and others on the use of recycled non-wovens for sound insulation.<sup>80,81</sup> Car manufacturers are co-operating with each other in various ways, for example Volvo will scrap Mercedes cars in Sweden and

Mercedes will scrap Volvo cars in Germany. Toyota are very active in recycling activities especially in Japan and they are co-operating with VW in Europe and also General Motors.

The second step in the recycling process is disassembly, which must be accomplished quickly to be economic. Plastics must be identified and sorted and different types must be separated from each other, which is not easy, and it may not always be possible to do this economically. The actual impetus for recycling only arose within the last 10 years or so and many of the cars currently being scrapped were not actually designed with recycling and disassembly in mind. In addition some components made maybe 10–15 years ago contain substances which are now considered toxic and therefore prohibited from being used in a new car. After many years' use certain materials such as the seat covers are likely to be heavily soiled, which means there will be high levels of contaminants with which to contend. This may add to the case for better cleanability of seat fabric.

The non-metallic parts of the car make up about 25% of the weight and comprise glass, rubber, plastics and textiles. These materials, about 300 kg in an average vehicle represent the biggest challenge with adhesives, paints, coatings and fasteners further complicating matters. At present the cost of dismantling, sorting and transporting components is not generally commercially viable but the pressure is on to change this or find alternative solutions. Vehicles being built at the present time benefit from these lessons and future ELVs should gradually become more and more easily dismantled. Cars being built now will not become ELVs until the year 2010 onwards and it has been suggested that when a polymer type is chosen for a car part, a second future use for it, at the end of the car's life, is decided in advance. To assist dismantling, the EU have requested OEMs to code car parts before the year 2000 and to produce dismantling manuals. One notable exception to the trend of easier disassembly is the move towards directly joining car seat covers to the foam cushion and squab in seat making.

Analysis of impact on the environment shows that the least expensive and least adverse effect on the environment is when a component can be recycled into its original product, i.e. so called 'closed-loop' recycling. The second best is when it can be used in another article which usually requires less demanding properties, for example face car seat fabric being recycled into backing material. The third option is to incinerate the material to generate useful heat but this generates the inevitable carbon dioxide and other gases, which may have to be treated before release to atmosphere. Plastics in fact, generally have high calorific values and are efficient fuel. The fourth and least satisfactory disposal method is landfill, which may, as has already been mentioned, produce environmental problems of its own. Some components consume so much energy and other resources to recycle them that

it is judged more overall environmentally friendly to use the two latter options. Each case has to be assessed on its own merits and in some countries of the world with a shortage of fossil fuels, such as Japan, incineration is a preferred option.

Car carpets are generally one polymer but with high levels of binders and a coating of bitumen or other material to assist vibration and sound absorption. They can also contain very large amounts of dirt – one report records up to 1 kg of dirt per square metre of carpet.

### 8.6.5 Use of natural fibres

In recent years there has been a revival of the use of natural materials in the automotive industry. The reasoning being that use of raw materials from renewable sources is more environmentally responsible than the use of synthetic fibres and plastics, which generally originate from limited oil reserves. In addition natural materials are more biodegradable than most synthetic ones but there are also technical advantages, such as adhesion to plastics and physical properties. Flax, sisal and hemp are being explored as replacements for the more expensive glass as long fibre reinforcement in polyurethane injection mouldings for door panels and in other applications. Some products are already on the market and are being used notably by German OEMs.<sup>82</sup>

The Crea Tech Process developed by Alpha Plastics and Haas Kunststoff has explored the use of natural thermoplastic material extracted from certain plants, which is filled with derivatives from wheat, oats and soya. The resultant compound resembles and has similar properties as ABS but will biodegrade under high humidity after 10 years. The same company has developed machinery and software for insert moulding using leather or Alcantara as the decorative material, which is bonded to a melt-injected plastic, such as polypropylene or ABS. The novel feature is that the bond between the covering decorative material and the rigid part is controlled to be adequate for the purpose but allows the materials to be separated at the end of the life of the car to facilitate recycling.<sup>83,84</sup>

### 8.6.6 Reduced emissions by reduced weight

Much development work has been carried out to reduce pollution by making the car lighter in weight. Some OEMs, have requested efforts be made to reduce car seat cover fabric weight by 30%. Generally this is not possible without compromising the fabric performance, especially abrasion resistance. The use of polypropylene, which is 30% lighter in weight than polyester, has already been discussed and it is generally unsuitable for car seat covers. It is suitable, however, for many other areas of the car, includ-

ing parts of the interior trim covering material, as backing fabric for carpets and also in woven velvet upholstery.

The car industry is responsible for 12% of all carbon dioxide emissions in Europe. Because of this the EU council of ministers of the environment have requested a contribution from the car industry so that the EU can comply with its commitment made at the Kyoto summit on the environment to reduce carbon dioxide emissions in Europe to combat global warming. In response the European Automobile Manufacturers Association (ACEA), have proposed very significant reductions by improvement of fuel consumption in new cars made in Europe.<sup>85</sup> The first step is to introduce to the EU market, no later than the year 2000, models emitting carbon dioxide corresponding to an average fuel consumption of 4.9 litres per kilometre (equivalent to 48.2 miles per gallon). Further improvements up to the year 2008 will result in car fuel consumption at levels 25% less than 1995 levels. The target quoted by the German chemical industry is the '3 litre car', i.e. a production car which will cover 100km using just 3 litres of fuel. This is equivalent to 94m.p.g. in the UK and 78m.p.g. in the USA.<sup>86</sup> This will require substantial savings in weight and will need contributions from all material suppliers. It has been reported that this target will not be met in high volume production cars until much of the glass in cars is replaced by lighter plastic substitutes. However, since that report, several small cars have been produced which can meet this target.

Textile fibre in the form of composites should contribute substantially to reduced traffic fumes by allowing considerable weight savings in the form of composites. However there are technical problems to be overcome before large metal replacement composites can be made commercially in the quantities required by the high volume automotive industry. Also, as previously described, advanced tyre cords and textile fibres-rubber combinations are already contributing to reducing rolling resistance in tyres leading to economies in fuel consumption and prolonged tyre life. The replacement of polyurethane foam and fibreglass by polyester or better still, polypropylene non-wovens could also reduce the weight of the car by useful amounts. Polyester however has certain processing advantages over polypropylene.

## 8.7 References

1. Alloway BJ & Ayers DC, *Chemical Principles of Environmental Pollution*, London, Blackie Academic, 1997, 10 (after Meadows DH and DL and Randers J, *Beyond the Limits*, London, Earthscan, 1992).
2. Watkins LH, 'Air Pollution from Road Vehicles', London, HMSO, 1991, 83.
3. Anon, 'The unfinished business after Kyoto', ENDS Report, December 1997, 275, 16-20.

4. Alloway BJ & Ayres DC, '*Chemical Principles of Environmental Pollution*', London, Blackie Academic, 1997, 168.
5. Murley L, (ed.), *1998 NSCA Pollution Handbook*, Brighton, NSCA Publications, 1998, 374.
6. Cooper P, 'Overview of the effect of environmental legislation in the UK textile wet processing industry', *JSDC*, 108, April 1992, 176–82.
7. Murley L, (ed.), *1998 NSCA Pollution Handbook*, Brighton, NSCA Publications, 1998, 8.
8. Gould R, 'Turning the screw; tightening up air quality standards', *EBM*, September 1998, 24–5.
9. Farrow L, (interview), 'IPPC project manager', *EBM*, April 1999, 12–13.
10. Gould R, 'Turning the screw: tightening up air quality standards', *EBM*, September 1998, 24–5.
11. Gould R, 'Voluntary schemes cut emissions', *EBM*, June 1998, 37.
12. Reed J, 'Directive moves to ban tyres from landfill', *EBM*, September 1998, 21.
13. Reed J, Draft landfill directive; main provisions as they affect UK, *EBM*, June 1998, 21.
14. Wagner SD, (Ciba), 'Regulatory issues impacting the textile industry', *Yarn Dyeing '96: Meeting the Challenges*, AATCC Symposium, Sunset Beach, NC USA.
15. Martin RL, 'Do the right thing with hazardous waste', *ATI*, March 1992, 60–2.
16. Hodges L, *Environmental Pollution*, New York, Holt, Reinhart & Winston, 1977, 70–1.
17. Arnold AE, 'Air regulations affecting the textile industry in New England', AATCC Symposium, *Coated and Laminated; Fabrics; New Processes and Products*. Danvers, MA, USA, 3–4 April 1995.
18. Devine TW, 'Air permits: effect on manufacturing', AATCC Symposium as ref 17 above.
19. Watkins LH, *Air Pollution from Road Vehicles*, London, HMSO, 1991, 66–82.
20. NSCA information leaflet, 'Air pollution and human health', Brighton, NSCA, April 1998.
21. Watson A, 'Generation problems, power generation and health', In *Health and the Environment*, London, SERA, 1996, 16–17.
20. Chanlett ET, *Environmental Pollution*, New York, McGraw-Hill, 1973, 204–7.
21. NSCA information leaflet, 'Motor vehicle pollution', Brighton, NSCA, April 1998.
22. Hodges L, *Environmental Pollution*, New York, Holt, Reinhart and Winston, 1977, 429–30.
23. NSCA information leaflet, 'Air pollution and human health', Brighton, NSCA, April 1998.
24. Jackson SL, 'ISO 14000: What you need to know', *ATI*, March 1997, 118–24.
25. Steadman L, 'Setting the standard; development in the ISO 14000 series', *EBM*, April 1999, 22–3.
26. Shaw T, 'European Union Integrated Pollution Prevention and Control Directive and its impact on the wool textile industry', *JSDC*, 114, September 1998, 241–6.
27. Laing IG, (Ciba) 'The impact of effluent regulations on the dyeing industry', *Review Progress Coloration*, 23, 1991, 56–71.

28. Jackson K, 'Water pollution – environment and civil liability', *JSDC*, 110, April 1994, 134–5.
29. Holme I, 'Flammability – the environmental and the Green movement', *JSDC*, 110, December 1994, 362–6.
30. Grund N, 'Environmental considerations for textile printing products', *JSDC*, 111, January/February 1995, 7–10.
31. Pierce G, 'Colour in textile effluents – the origins of the problem', *JSDC*, 110, April 1994, 131–3.
32. Aurich CW, 'Waste water treatment – choosing the right membrane system', *JSDC*, 111, June 1995, 179–81.
33. Willmott N, Guthrie J & Nelson G, 'The biotechnology approach to colour removal from textile effluent', *JSDC*, 114, February 1998, 38–41.
34. Steenken-Richter I & Kermer KD, 'Decolorising textile effluents', *JSDC*, 108, April 1992, 182–6.
35. Moran C, 'Reducing the toxicity of textile effluent', *JSDC*, 114, April 1998, 117–18.
36. Webb J, 'Polyurethane plant emissions control', *Urethanes Technology*, October/November 1995, 20–2.
37. Webb J, 'Flame laminators watch out – you are on the list', *Urethanes Technology*, October/November 1995, 23.
38. Motschi H & Clarke EA, 'Regulatory developments affecting European manufacturers and processors of dyes and pigments', *Review Progress Coloration*, 28 1998, 71–9.
39. Anon, 'Fire research points finger', *PRW*, 24 July 1998, 1.
40. Anon, 'Oestrogens research fingers flame-retardant chemical', *The ENDS Report*, 267 April 1997, 9–10.
41. Anon, 'Bromine industry strengthens its defences', *The ENDS Report*, 273 October 1997, 9–10.
42. Anon, 'Life cycle benefits of flame retardants' *PRW*, 10 December 1998, 2.
43. Anon, 'DTI backs FR cause' *PRW*, 12 February 1999, 3.
44. Anon, 'PVC in cars comes under EC microscope' *PRW*, 18 July 1997, 2.
45. Anon, 'BPF helps defeat EU car material policy change', *PRW*, 19 February 1999, 3.
46. Fuad-Luke A, 'The green grossers', *The Guardian*, 11 March 1999, 14.
47. Neitzel H, (Federal Environmental Agency), '20 years of experiences of the German Environmental Labelling Scheme, Blue Angel', *Consumers Council Conference*, Washington DC 24–5 April 1998.
48. McCarthy BJ and Burdett BC, 'Eco-labelling and textile ecology', *Review Progress Coloration*, 28 1998, 61–70.
49. Zippel E, Oeko-Tex Labelling, *Eco-Textile '98-Sustainable Development Symposium*, Bolton Institute, Proceedings edited by Horrocks, AR, Cambridge, Woodhead Publishing, 1999.
50. Pryweller J, 'Ford sets tough new guidelines for recycled plastics', *Automotive News Europe*, 5 July 1999, 22.
51. Anon, 'Compounders respond to recycling demands', *MPI*, April 1999, 12.
52. Anon, 'Ford is targeting 50% use of recycle-content resin by 2002', *MPI*, July 1999, 26.
53. Anon, 'DaimlerChrysler ups recycling stakes', *ISATA magazine*, June 1999, 12.

54. Anon, 'End of life vehicles (ELVs) recovery; European situation', *Automotive Textiles Newsletter*, April 1997 Marvel/Rhone-Poulenc Setila, 4.
55. Piech F, (VW), 'ELV burden is too heavy', *Auto News International*, October 1999, 34.
56. Anon, 'ELV Directive blocked again', *FT Auto Environmental Analyst*, 54, July 1999, 2, 13–14.
57. Wylie I, 'EU crusher on manufactured goods', *Motor Industry Management*, July/August 1999, 36–7.
58. Ehler P & Schreiber H, 'Textile waste again in automotive application.', *R'97 International Congress*, Palexpo, 4–7 February 1997, St Gall, Switzerland, EMPA.
59. Weber A, (BASF), 'Potential for recycling plastics from scrap cars', *PRW*, April 14 1990, 13.
60. Rebboah S & Smith GF, 'Recycling implications in the motor industry', (C524/142/97), *Autotech '97*, 4–6 November 1997, Bury St Edmunds, UK Mechanical Engineer Publications, 1997.
61. Kmitta S, (Fehrer), 'Polyester nonwovens – an alternative for car seats', *IMMFC*, Dornbirn, 20–2 September 1995.
62. Wilkens C, 'Raschel knitted spacer fabrics', *Melliand English*, (10) 1993, E348–E349.
63. Karl Meyer/Malimo technical information leaflet, 'Manufacture of fabrics for automotive interiors using warp knitting and stitch bonding', *We* 75/1/93.
64. Fuchs H & Bottcher P, 'Textile waste materials in motor cars – potential and limitations', *Textil Praxis Internat*, April 1994, (4) II–IV.
65. Hirschek H, 'Recycling of automotive textiles', *IMMF*, Dornbirn, 22–4 September 1993.
66. Costes M, (Rhone-Poulenc), 'Use of textiles in vehicles and recycling; state of the art and outlook', *IMMF*, Dornbirn, 22–4 September 1993.
67. Kiefer B, Bornhoff A, Ehrler P, Kingenberger H & Schreiber H, 'Assessing second hand automotive textiles for use in new vehicles', *IMMF*, Dornbirn, 20–2 September 1995.
68. Coll-Tortosa L, 'Recyclable upholstery textiles for the automotive industry' (BRITE-EURAM project), *IMMF*, Dornbirn, 16–18 September 1998.
69. Schmidt G, 'Replacing foam by using "Kalitherm" technology and flameless laminating', *IMMFC*, Dornbirn, 15–17 September 1999.
70. Schmidt G & Bottcher P, 'Laminating nonwoven fabrics made from or containing secondary or recycled fibres for use in automotive manufacture', *Index Conference* 1993, Brussels, EDANA.
71. Fung W, 'Properties required for nonwovens for use in motor cars as substitutes for other materials' *Index Conference*, Geneva, 28–9 May 1999, Brussels, EDANA.
72. O'Toole K, 'Waste issue takes centre stage', *European Plastic News*, November 1991, 60–6.
73. Hillier K, 'The recycling of flexible polyurethane foam', Chapter in *Chemical aspects of plastics recycling*, Cambridge, Royal Society of Chemistry, 1997.
74. Caligen Foam Fact Sheets, 'The environmental choice – polyurethane' and 'A clearer focus on recycled foam' – with ARCO.
75. ISOPA – European Isocyanates Producers' Association, seven fact sheets on recycling options for polyurethane foam. October 1993.

76. Anon, 'ACORD deal agreed', *MRW*, 18 July 1997, 3.
77. Anon, 'PRAVDA—the moment of truth?', *EPN*, September 1991, 58–9.
78. Eminto S, 'Vehicle recycling – UK to take voluntary route', *MRW*, January 1997, 12–14.
79. James B, 'Rover takes CARE to meet European goals', *PRW*, 7 February 1997, 7.
80. Anon, 'Automotive textiles', *Kettenwirk-Praxis*, (3) 1995, E30–E32.
81. Trautmann J, 'Recycling of automotive textiles', *Textile Asia*, March 1998, 45–6.
82. Mapleston P, 'Automakers see strong promise in natural fibre reinforcements', *MPN*, April 1999, 63–4.
83. Roth T, (Alpha Plastics), 'Launch of new technology', Lecture, University of Sheffield, 23 February 1993.
84. Anon, New German technology may promise easier recycling', *PRW*, 20 March 1993, 9.
85. Anon, 'News Opinion', *FT Automotive Manufacturing*, Issue 1 May 1998.
86. Grace K, 'Polymers are crucial for the motor industry to meet its aspirations', *BPR*, November 1996, 26–30.

## 8.8 Further reading

1. Alloway BJ & Ayres DC, '*Chemical principles of environmental pollution*', 2nd edn, London, Blackie Academic, 1997.
2. *Automobile Material Technology-Proceedings of Autotech '97*, 4–6 Nov 1997, Bury St Edmunds, UK, Institute of Mechanical Engineers, 1997.
3. BS EN ISO 14001: 1996, British Standards Institution, London.
4. Chanlett ET, '*Environmental Protection*', New York, McGraw Hill, 1973.
5. Cooper P, '*Colour in dyehouse effluent control*', Bradford, SDC, 1995.
6. Degobert P, '*Automobiles and Pollution*', Paris, SAE and Editions Technip, 1995.
7. DETR brochures, '*The Environmental Impact of Road Vehicles in use*' and '*Driving the Agenda*', The first report of the cleaner vehicle task force, both July 1999.
8. DETR, '*A Better Quality of Life, A Strategy for Sustainable Development*', London, HMSO, 1999.
9. Dept of Environment, '*Indicators of Sustainable Development for the United Kingdom*', London, HMSO, 1996
10. Engineers' Employers Federation (EEF), '*The EEF Register of Environmental Registration*', London, EEF, 1999.
11. Hodges L, '*Environmental Pollution*', New York, Holt, Reinhart & Winston, 1977.
12. Horrocks AR (ed.), '*Ecotextile '98 – Sustainable Development*', Proceedings of conference held at Bolton, 7–8 April 1998, Cambridge, Woodhead Publishing, 1999.
13. Kachadourian G, 'Green v Green', *Automotive Recycling*, *AI Automotive Industries*, October 1999, 41–4. Also [www.ai-online.com](http://www.ai-online.com) (Automotive recycling, USA).
14. Moran T, 'To recycle, or not to recycle? Is it truly viable?', *Automotive & Transportation Interiors*, November 1999, 26–31.
15. Murley L, *1998 NSCA Pollution Handbook*, Brighton, NSCA Publications, 1998.

16. R'97 Industrial Congress, Palexpo, 4–7 February 1997, Geneva, St Gall, Switzerland, EMPA.
17. Sheldon C & Yoxon M, '*Installing Environmental Management Systems – a Step by Step Guide*', London, Kogan Page, Earthscan, 1998.
18. *Time Magazine* special edition, Our Precious Planet, (includes feature 'The Green Car'-Toyota Hybrid), November 1997.
19. UNEP (United Nations Environmental Programme), '*Global Environmental Outlook 2000*', London, Kogan Page, Earthscan, 1999.
20. Watkins LH, '*Air Pollution from Road Vehicles*', London, HMSO, 1991.
21. Wragg PJ, 'Where to now with FR?', *Eco-textile '98*, 7–8 April 1998 Bolton, Conference proceedings, (ed. R Horrocks), Cambridge, Woodhead Publishing, 1999.

## 9.1 Introduction

In a similar way to the automotive industry, textiles provide a means of decoration and a warm soft touch to interior surfaces in all road vehicles, trains, aircraft and marine vessels, but are also used extensively in more functional roles. Also in common with the automotive industry, the comfort, safety and weight-saving factors are the driving force behind many developments. Weight saving is of especial importance in the aircraft and freight transport industries where any weight saved means increased payload and hence increased profits. In any situation where the general public is involved, safety is of the highest importance, and reduced flammability of textiles to very high standards are necessary, especially in aircraft. Furthermore public safety standards are usually requirements of government legislation.

The whole area of transportation is growing with increasing trade between the nations of the world which is generating higher volumes of both freight and passenger travel. Tourism is increasing as people have larger disposable incomes, increased leisure and become more interested in foreign cultures. The largest growth is expected in air travel and already intensive competition is bringing airfares down. More pleasing and relaxing travel conditions are necessary to attract fare-paying passengers who now have a wide choice of different travel companies and indeed the travel modes of rail, road and air now compete with each other. Another recurring factor in textiles in transportation applications is ease of cleanability because expensive vehicles such as jumbo jets or high-speed trains must earn their living by being in service and on the move as much as possible. Lengthy periods between journeys or being out of service for overhauls is wasted time and time is money. However, cleaning is important because dirty and untidy interiors would deter passengers.

Weight saving is important in all forms of commercial transport because it can make all the difference between profit and loss and in common with private cars, weight saving now has environmental implications; less weight

means less depletion of natural energy resources and less pollution from exhaust fumes. Composites are playing an important role in this area and are certain to make an even larger contribution in the future. The use of composites in Europe is growing at a rate of 10% every year and by 2001 the market value will be almost 50% more than the 1997 level – a significant proportion will be in transportation applications.<sup>1</sup>

It is unfortunate that it has taken headline news disasters such as the Salt Lake City air disaster of 1965 and the Manchester airport fire of 1985 to drive up FR standards in public safety situations. Seating fire barriers, first developed for aircraft, are also becoming increasingly required in trains and road passenger vehicles.

Aesthetics and interior design of aircraft, trains and all other forms of transport are becoming increasingly important with rising living standards and increased expectations from the general public. However decor of trains and aircraft cannot be changed frequently and so pleasing but generally neutral designs are used free from transient fads or fashions.<sup>2</sup>

This chapter is preceded by three introductory sections on three subjects, which characterize transportation textiles, i.e. composites to save weight, increased safety by reduced flammability, and coated fabrics, the basis of much safety and survival apparatus and also the means of protection of both man and materials from the elements. A summary of the properties of the main fibres used in transportation applications appears in Tables 9.1 and 9.2.

## 9.2 Composite materials

Composites straddle the textile and plastic industries and can be regarded as a macroscopic combination of two or more materials to produce special properties, which are not present in the separate components, (an alloy is a combination on the microscopic scale). How composites work, can be illustrated by the analogy of the use of straw in clay bricks by the ancient Egyptians. It was possible to produce a strong brick because the straw reduced and controlled the occurrence of cracks in the hard but brittle clay. Glass fibres, used very extensively in modern composites, have a very high tensile strength, but are very brittle because of their extreme sensitivity to cracks and surface defects. However when incorporated into a composite, the plastic matrix protects their surface and prevents crack formation. Thus the high tensile properties of the fibre are protected and the two materials between them produce a strong composite. In general terms, the chemical properties are determined by the plastic component, and the physical properties determined by the fibre. Introductory accounts of composites are available in the technical literature,<sup>3-6</sup> including uses in transportation applications.<sup>7-11</sup>

Table 9.1 Properties of fibres used in transportation

	Density (g/cm <sup>3</sup> )	Melting point (°C) *	Tenacity (g/den) **	Stiffness (flexural rigidity (g/den)	Limiting oxygen index % Oxygen	Abrasion resistance	Resistance to sunlight
Acrylic	1.12–1.19	150d	2.0–5.0 (HT)	5.0–8.0	18	Moderate	Excellent
Modacrylic	1.37	150d	2.0–3.5	3.8	27	Moderate	Excellent
Nylon 6	1.13	215	4.3–8.8 (HT)	17–48	20	Very good	Poor – good when stabilized
Nylon 66	1.14	260	4.3–8.8 (HT)	5.0–57	20	Very good	Poor – good when stabilized
Polyester	1.40	260	4.2–7.5 (HT)	10–30	21	Very good	Good – excellent when stabilized
Polypropylene	0.90	165	4.0–8.5 (HT)	20–30	18	Good	Poor – good when stabilized
Wool	1.15–1.30	132d	1.0–1.7	4.5	25	Moderate	Moderate
Cotton	1.51	150d	3.2	60–70	18	Moderate	Moderate

Table 9.1 (cont.)

	Density (g/cm <sup>3</sup> )	Melting point (°C) *	Tenacity (g/den) **	Stiffness (flexural rigidity (g/den)	Limiting oxygen index % oxygen	Abrasion resistance	Resistance to sunlight
Ultra high modulus polyethylene	0.97	144	30	1400–2000	19		
Aramid	1.38–1.45	427–482d	5.3–22	500–1000	29–33		
Carbon	1.79–1.86	3500d	9.8–19.1+	350–1500	64+		
Glass	2.5–2.7	700	6.3–11.7	310–380	—		
Polybenzimidazole	1.30	450d	—	9–12	41		
Inidex (Acordis)	1.50	—	1.2	—	40		
Panox (LUCF)	1.40	200–900d	—	—	55		
Steel	7.90	1500	2.5–3.2	167–213	—	—	—
Aluminium	2.70	660	—	—	—	—	—

1. \* d = does not melt but starts to degrade

2. \*\* HT = High tenacity

3. Thermoplastics begin to *soften* at temperatures below their melting point and thermoplastic fibres can deform or be damaged by the action of temperature well below their melting point. This is more likely if the heat is combined with pressure as for example in a lamination or a moulding operation.

NB: Data compiled from several sources and intended only as a guide.

*Table 9.2* Additional values of limiting oxygen index (% oxygen)

Zirpro Wool	30
Cotton (Pyrovatex finish)	28–30
Cotton (Proban finish)	28–30
Viscose	18
Viscose FR	28
Polyester FR	28–30
Visil (modified viscose)	26–33
Basofil (BASF)	33
Chlorofibre	35–48
PTFE	80–90

The oxygen content of air is 21%, an LOI above this figure is an improvement in FR properties.

NB: Data compiled from several sources and intended only as a guide.

### 9.2.1 Fibres used in composites

Glass reinforced plastics (GRP) date from the 1920s and combine high strength with light-weight properties. Several different glass compositions and their variants have been formulated to produce specific properties. The original, referred to as A-glass, used in windows is now not used for fibres. E-glass which has special electrical properties necessary for radomes, (radar covers), is now the type produced on the largest scale followed by C-glass which was developed for its chemical resistance and D-glass, which is an improved form of E-glass.

During the 1960s more advanced fibres became available, carbon and aramid fibres and others which are all many times stiffer than glass but, with the exception of aramids, are brittle and must be used in combination with other materials. Each fibre has its own merits and disadvantages and no single fibre can be regarded as overall superior to the others. Carbon fibres were first produced at the Royal Aircraft Research Establishment during 1963 in England. There are a number of different varieties and their properties vary significantly depending on the conditions of manufacture. The stages in the process are spinning, stabilization, carbonization and graphitization. Most carbon fibres nowadays are made from an acrylic fibre precursor.

Aramid fibres date from the early 1960s with the introduction by DuPont of Nomex, aromatic polyamide (hence the name ‘aramid’).<sup>12</sup> This fibre has very high strength with excellent temperature resistance with 60% strength and modulus retention at 260 °C. It does not melt but chars to a black, crust-like material, which acts as a barrier at about 317 °C without giving off toxic

fumes. Kevlar, a variant of Nomex introduced by DuPont about 10 years later, is weight-for-weight five times stronger than steel wire, has a modulus twice that of glass but a density of only  $1.45 \text{ g/m}^3$  compared with  $2.5 \text{ g/m}^3$  for glass and  $7.8 \text{ g/m}^3$  for steel. Aramids are resistant to many solvents, have low water absorbency but they are sensitive to UV light and are not easily dyed. Several different variants of Kevlar have been introduced over the years, each for a particular specialized application.

In addition to the main three fibres, more specialist types have been produced including, ceramic, boron, metallic, quartz (pure silica), silicon carbide and the ultra high modulus polyethylene fibre which is finding many applications in transportation applications. In recent years the benefits and opportunities offered by natural fibres as composite reinforcement have been recognized and they have the advantage of being a replaceable resource.

### 9.2.2 Properties of composites

There are very many potential combinations of fibre and plastics, but in actual fact most composites are based on just three fibres: glass, carbon and aramid, or a combination of them, in a polyester, epoxy or phenolic resin. The density of these three resins, which are all thermosetting at about  $1.2 \text{ g/m}^3$ , is considerably less than even aluminium. Chemical properties are determined mainly by the fibre component, the chemical and thermal properties mainly by the polymer. Phenolic resins have the best heat resistance and fire-retardant properties of the three main resins. The fibre can be in the form of chopped lengths, short, long or continuous filament or in any fabric construction, woven, knitted or non-woven. The fibre length and orientation influence properties: the longer the fibre length the stronger the composite, with the strongest being obtained from composites made from actual fabrics or continuous filaments.

Carbon fibre composites, in general provide the highest stiffness and strength but they can be brittle and have low energy-absorbing properties. Aramid composites have lower strengths but can absorb energy without fracture. Glass-fibre composites fit in roughly somewhere below aramid fibres in terms of strength but they have some energy-absorbing properties and have the advantage of being less expensive.

### 9.2.3 Advantages of composites

At the present time the most significant advantage of composites is in the replacement of heavier metal with lighter components, which results in fuel savings throughout the life of the vehicle. Actual material cost of composites exceeds that of metal but there are several other significant benefits

from their use. These include less bulk, and therefore more useful space, anti-corrosion, dent resistance, and high rigidity and strength. All of these properties make composites well suited to transportation applications. Composites also allow more design freedom, which means that complex shapes not easily produced in metal, can be more easily achieved. This is especially important in transportation applications where an aerodynamic shape is important. The various fibres, resins, additives and processing conditions available, enable properties to be tailored to suit the intended application. Integration of components is also more easily achieved when a single composite can replace several individual parts in metal which all have to be joined together. A good example is the 'stealth bus' prototype in California, in which 250 parts in a conventional bus, have been replaced by just three structural composites.<sup>13</sup> This bus, nicknamed after the stealth bomber, has an expected life of 25 years compared with 8–12 years for an ordinary bus and, being over 4000 kg lighter will save very large amounts of fuel during its lifetime.

With such significant fuel savings possible, some analysts believe it is only a matter of time before we see carbon fibres in large volume production cars but there are many technical and commercial problems to overcome first. Carbon fibres are not as easily processed as polyester or the more common fibres. For low volume production, such as specialist sports cars, goods vehicles, trains and aircraft, composites are feasible, but when large-scale mass production is considered, there are at present, prohibitive cost and technical difficulties. The production of carbon fibres is expected to grow by about 10% annually at least until the year 2001, although not all of it will be in transportation.<sup>14</sup> More advanced fabric structures and indeed more advanced fibres are being developed which are extending the scope of composites all the time.<sup>15–17</sup>

The absence of metal makes composites useful in items such as radomes. Composites may be more expensive than metal to initially produce but if a life-cycle analysis is carried out, the savings in fuel over the time in use far outweigh the extra costs of production. Composites are well suited to transportation applications in allowing savings both in weight and space. Disadvantages of composites include, susceptibility to impact damage, limited temperature and moisture resistance in some cases and at present limitations on repairability and joining techniques.

Composites are enabling 'breakthroughs' in technology not thought possible several decades ago. The first man-powered aircraft, the Gossamer Albatross on 12th June 1979 flew across the English Channel in 2 h 49 min. The flight was sponsored by DuPont and would have been impossible without Kevlar as structural reinforcement. More recently the round-the-world hot air balloons all make use of Kevlar. Composite technology is still in its infancy, compared to metals and other materials, which have many

decades and even centuries of accumulated knowledge. More significant advances can be expected in the future, with increased use of composites in all forms of transport.

Weight saving is especially important in aircraft because it significantly influences their commercial viability, and composites are playing a vital role in this area. The Airbus A-300 in 1980 was the first commercial aircraft to use significant amounts of composite material – about 6% of its body weight. This does not sound much, but on take-off the total weight of a plane, very roughly, comprises 50% aircraft structure, 25% fuel and 25% payload. Decreasing the body weight by 6% increases the payload's possible proportion to 28% of the whole plane weight. This increases the actual payload, i.e. the part that earns the money, by a very worthwhile 12%, which could make all the difference between profit or loss. These same considerations of course also apply to all other forms of freight commercial vehicles.

#### 9.2.4 Fabrication of composites

Large components such as the hulls of yachts and small boats, are still frequently made by hand laying of non-woven glass fibre into a mould and applying polyester resin with a brush, building up layers as necessary and manually rolling to compact it into shape. Non-woven polyester fabrics are used as processing aids in this and other moulding operations to line the mould. They must be conformable to the shape and designed to equalize pressure in the mould and to allow the escape of gases and vapours during the curing process, an example is the Lantor Breatherfelt material. In specialist moulding operations, non-wovens can improve the surface appearance of components.

A layer of a novel non-woven honeycomb-structured polyester material, Firet Coremat developed by Lantor can be incorporated into the inner parts of the resin structure to produce significant weight savings. The non-woven fabric also contains microcapsules, which expand on the action of heat during the curing process and further contribute to the weight saving. This material also reduces vibrations, which is especially beneficial in transportation applications.

Most items relevant to passenger cars are produced by various moulding techniques. Moulding is a faster means of production than hand fabrication, but the cost of moulds and tools can be very expensive and in time, need replacing or renovation. Low production volumes may not recoup the cost. Short-length fibres, resin, catalyst, pigments (if necessary) and other additives are blended together and injected into the mould where heat is applied to cross-link the resin. Small external body parts and headlamp housings are made in this way. For larger components longer continuous filaments

can be laid in to increase the strength in a linear direction. However, the manufacturing techniques required to produce large components in high volumes for regular production cars are not yet available for composite material and much research is working towards this end. The American 'big three', General Motors, Ford and Chrysler, together with the US government have pooled their resources in finding a solution to these problems.<sup>18</sup> Many other researchers around the world are also studying the problem but so far with only limited success.<sup>10,11</sup> However, the use of composites and plastics for small items in passenger cars continues to grow steadily. Large component composites are at present restricted to relatively small volume production such as in heavy goods vehicles, speciality cars, trains and aircraft.

Some composites are produced from fabrics pre-impregnated with resins, a 'pre-preg', which can be cross-linked in a later process. Layers of pre-pregs can be laminated and cross-linked together to form very strong materials. Continuous profile composite structures can be produced by a process termed pultrusion, which is low cost and involves drawing pre-treated fibres through a heated die. Circular or hollow structures can be produced by winding a continuous fibre filament on to a former. The filaments are immersed beforehand in a cross-linkable resin. When the required shape and thickness have been achieved, heat is applied and the filament layers are cross-linked together.

## 9.3 Flame retardancy

### 9.3.1 Basic mechanisms

Reduced flammability is a general safety requirement of virtually all textiles in the passenger transportation area. This section attempts to explain the main principles governing flammability and its control. Many articles have been published on these aspects and also the relevant test methods.<sup>19-25</sup> Burning depends on three factors, a source of ignition to provide the initial heat energy, fuel or materials capable of burning and a supply of air which contains oxygen (or an oxidizing agent), the gas on which combustion depends. Anything, which reduces these factors reduces combustion, which is essentially a chemical oxidation process. Heat energy first causes molecules of the fuel to break down into smaller parts called 'free radicals' which are unstable and therefore highly reactive. Burning proceeds by the formation of these free radicals and their subsequent reaction with oxygen. Certain flame retardancy (FR) agents under the action of heat, break down producing their own free radicals. The fuel free radicals then react preferentially with the flame-retardant free radicals instead of with oxygen, thus inhibiting combustion. An uncontrolled fire with a supply of fuel is self

propagating in that heat from the burning material heats up the surrounding air and the material not yet burning.

### 9.3.2 Mechanisms of flame retardant chemicals

Hydrated chemicals contain significant amounts of water and when heated, this water is released, cools the flame and the water vapour formed dilutes the oxygen in the air. An example is aluminium trihydrate, which contains 35% of its weight of water. Chemicals such as aluminium hydrates and some boron compounds take in energy (endothermic) on decomposition, and the flame is cooled by this process. Materials, which decompose to release non-flammable gases such as carbonates, have some flame-retarding properties. Some chemicals will function by more than one mechanism.

The most effective mechanisms however are by inhibition of the free radicals and by reducing the availability of fuel by formation of a barrier of protective char. Chlorine and bromine (halogen) compounds have been found to have good FR properties especially in combination with antimony trioxide and the 'antimony/halogen synergy' is the basis of many FR formulations; antimony trioxide alone has no FR properties. The halogen compound releases free radicals, which react in the gaseous phase with the free radicals produced by the burning polymer. Thus reaction with oxygen is inhibited and burning retarded. This method is very effective and is widely used in plastics but it has the disadvantage of producing potentially toxic fumes.

Some chemicals or combination of chemicals prevent afterglow and re-ignition, others on combustion, form a char or barrier which effectively reduces air reaching the burning material. An example is zinc borate, which forms a glass-like coating and is claimed to significantly suppress smoke. Chemists have developed this concept and produced 'intumescent' coatings which form at relatively low temperatures, i.e. at an early stage of combustion, to produce a voluminous insulating char. This barrier inhibits flame spread by restraining the escape of gas formed by burning and also the access of oxygen to the flame. Intumescent coatings can be effective at low concentrations – intumescent paints are available – and continue to be developed. They contain a source of carbon, a 'blowing agent' to increase the volume, and fillers and other chemicals. Ceepree, invented in the laboratories of ICI is an FR system which works on the barrier principle.

Phosphorus FR chemicals work by encouraging the formation of char and are reported to suppress glowing which produces carbon monoxide and carbon dioxide and also carries the risk of re-ignition. Phosphorus FR agents in combination with certain nitrogen compounds produce an FR synergy for cellulosic materials. Certain polymers such as PVC and especially PVDC (polyvinylidene chloride) already contain high levels of FR

chemical species such as chlorine and have inherent FR properties. These polymers have been used as FR compounds themselves, for example, the use of PVDC in styrene butadiene rubber to back coat automotive carpets.

### 9.3.3 Disadvantage of FR chemicals and recent developments

The main disadvantages of FR compounds are cost, problems associated with compounding, toxicity of fumes from burning and more recently environmental considerations. The most efficient FR chemical synergy for plastics, antimony trioxide and organic bromine compounds are not cheap and they have to be compounded into a polymer system or coating recipe. When compounding and coating automotive fabric with water-based systems, care is needed because the FR chemicals are solids and need surfactants and thickening agents to produce a uniform compound with reasonable shelf life. There is the danger of the solids separating out during storage or transportation or during the actual coating process giving rise to an unsightly appearance and irregular test results.

Many chlorine and bromine chemicals are believed to be potentially toxic and are subject to control or prohibition. Both antimony trioxide and bromine FR chemicals have been under environmental scrutiny for several years, and this seems to have intensified recently. The search has been on for alternative chemical systems with only limited success so far. Not everyone is convinced that the materials are hazardous; the bromine industry is calling for independent reports. Others believe there is greater risk from being burned in an accident, than the risk from bromine as an environmental pollutant. This has been discussed above in Chapter 8.

Among the alternative chemicals put forward are zinc hydroxystannate, zinc stannate, and systems based on zinc borate. However there is a quite widely held view, that a higher concentration of the alternative materials is required to produce the performance obtained with a lower level of an antimony/bromine system. In certain applications, it is possible to simply increase the loading of FR filler and chemicals but this is not easy with fabric coatings, where increased amounts of additives and add-on cause fabric stiffening. Also, there is a limit to the amount of FR chemical, which can be mixed into water or solvent-based resins for fabric coating.

### 9.3.4 The burning process

The stages of combustion are ignition, growth, propagation and finally decay, but all fires in real-life situations are unique in that the circumstances and conditions are never exactly the same. The way fabrics burn depends upon a variety of factors and combination of factors including fabric stiff-

ness, drape, contact with or proximity to other materials, supply of air, draughts, etc. Fire is not only a hazard because of the danger of contact with flames, but also because of suffocation by toxic fumes, injury from heat levels and heat stress, all the dangers associated with panic and the inability to escape due to routes being obscured by dense smoke. Individual test methods have been devised to take all these factors into consideration, some of them after lessons learnt in actual transportation disasters.

### 9.3.5 Fireblocker materials

These fabric fire barriers were originally developed for aircraft seating but are now becoming required for passenger trains, buses, coaches and other road vehicles. There is now a whole variety of different fabrics being used for this component to combine FR performance with comfort, light-weight properties and minimal cost.<sup>26–29</sup> However some seats are made from foams with very high standards of FR properties, such as ‘graphite’ foam and in these cases fireblockers may not be needed.<sup>30,31</sup> This subject is discussed below in aircraft furnishings.

### 9.3.6 Fire safety in transportation

Standards for public safety are invariably controlled or influenced directly or indirectly by government departments, for example, the Civil Aviation Authority in the UK or the Federal Aviation Authority in the USA for safety in aircraft. The International Maritime Organization is responsible for safety at sea. The FR standards, although aimed at reducing ignition, propagation speed, heat and smoke are also intended to allow sufficient time to safely evacuate the aircraft or marine vessel and it is difficult to test for this overall factor. All textiles on passenger aircraft, marine vessels, trains and road vehicles throughout the developed world are subject to FR testing. Fibres with inherent FR properties, which are not removed by washing or dry cleaning are now available for furnishings such as curtaining, upholstery, bed linen. These include polyesters, Trevira FR and CS (comfort and safety), Fidon FR from Montefibre, Viscose FR from Lenzing and the more specialist fibres, modified acrylic and aramids. In addition the durable FR treatments, Proban (Albright and Wilson) and Pyrovatex (Ciba) are available for cellulosic fibres. Zirpro treatments are available for wool. As usual, cost and performance need to be balanced and the specialist fibres are frequently blended with regular fibres.

## 9.4 Fabric coating

Coated fabrics are engineered materials produced by a combination of a textile fabric and a polymer covering which is applied to the surface.<sup>32–41</sup>

Fabric coating confers new properties to the fabric such as impermeability to dust particles, liquids and gases and it is also possible to improve existing ones such as abrasion as has been seen with car seat fabric in Chapter 4. The most familiar coated fabrics are tarpaulins and waterproof protective clothing material. The fabric component determines the tear and tensile strength, elongation and dimensional stability, the polymer mainly controls the chemical properties, abrasion and resistance to penetration by liquids and gases. Many properties are determined by a combination of both components together and both base fabric and polymer must be carefully selected by thorough consideration of the properties required in the finished article. Other coated fabrics in the transportation area include materials for life jackets, life rafts, safety chutes, hovercraft skirts, protective coverings, awnings, aircraft fuel tanks, flexible containers and airbags. Aesthetic effects can also be achieved by fabric and polymer combinations; man-made leathers used for seat covers and apparel are essentially coated fabrics.

#### 9.4.1 Base fabrics used

For quality coated fabrics, quality base fabrics are essential. This point is made because newcomers to the industry sometimes believe that the coating can cover fabric defects, when in fact the defect is frequently made more prominent. The cost of rejected coated fabric, with the added value of coating is higher than that of base fabric alone! Polyester and nylon are the main fibres used because of their strength and general resistance to moisture, oils, micro-organisms and many common chemicals.<sup>36,37</sup> Generally polyester is more resistant to light and UV degradation than nylon, although nylon is more resistant to hydrolysis. The use of polyester, however, has grown at the expense of nylon because of its better dimensional stability and shrink resistance and lower extensibility. High tenacity yarns are used in many coated articles for extra strength and aramid fibres used, where more specialist properties are required. Acrylic fibres are used for some applications where very high UV resistance is necessary, such as car roofs. Cotton is still widely used and has certain advantages over synthetic fibres such as polymer adhesion, the cotton being rougher and of short fibre length, provides more opportunity for mechanical anchoring. The smoother synthetic fibres frequently require some means of promoting fibre-polymer adhesion especially with PVC plastisols and rubber coatings. A fabric coating is essentially a joining operation and the principles of adhesion apply, i.e. the fabric must be clean and free of dirt, dust, oils and any fabric finish to obtain the best results of coating adhesion. Fabrics are therefore preferably scoured (and rinsed thoroughly), and heat set to stabilize the fabric before coating.

In some cases, the fabric is pre-treated with an adhesion promoter. Much research work has been carried out to improve polymer fabric adhesion, especially for rubber and for composites. Research work has been directed at polyester and aramids using corona discharge and plasma treatments.<sup>42-45</sup>

Only a very small number of fabric constructions are used for polymer coating for transportation and industrial uses, i.e. plain weave, twill and basket constructions. To combine weight with high tear strength, rip-stop constructions are sometimes used; a stronger yarn is inserted every 5 mm or so. Knitted fabrics are used for apparel and are transfer coated to obtain soft handle. Fabrics are sometimes slightly raised or napped to improve coating adhesion.

#### 9.4.2 Polymers and compounds used

The physical and chemical properties required largely determine which polymer type to coat on to fabrics, although cost and ease of processing are also important factors. Few polymers are used entirely on their own, but are mixed with other chemicals to improve a particular property or to assist with processing.

Coating mixes or compounds (sometimes referred to as ‘cocktails’), can contain up to six or more different ingredients, each one having a role to play. PVC plastisols, used to produce tarpaulins, generally consist of the PVC, which could itself be a mixture of two or more different grades, a plasticizer which generally determines flexibility and other properties, stabilizers against light and heat degradation, pigment for colour, and possibly filler for economy. Sometimes secondary plasticizers are also included to help ‘tailor’ the properties to the particular application and flame-retardant chemicals, although PVC itself is quite inherently flame retardant.

Rubber compounds will generally contain at least a similar number of ingredients together with vulcanizing (this essentially means the same as cross-linking or curing) chemicals. Each ingredient must be chosen carefully for compatibility with the others and for minimization of side effects. With so many components, formulation and mixing of the compound are skilled operations – the importance of which is sometimes not appreciated. Many problems arising in production and during use by the customer, have their origins in the compounding stage and frequently, coating factories buy in ready-compounded mixtures and masterbatches, especially when pigments are involved.

In addition to the main ingredients, processing aids are frequently needed to control the viscosity of the mixture, which may change during the coating process. The flow properties are referred to as the rheology of the compound. Under the shearing action of the coating blade, the viscosity of the

resin may become thinner, causing penetration through the base fabric – this is termed thixotropic behaviour. The converse is called rheopectic behaviour, whereas resins with constant viscosity are said to have Newtonian properties. Viscosity must be monitored frequently with a suitable instrument such as the Brookfield viscometer, (using the appropriate spindle) or Ford cup.

Most fabric coating comprises more than one layer and it is quite common for each layer to be different, requiring separate compound recipes. In general the first or base layer is soft and flexible and in the case of both PVC and rubber compounds it contains special chemicals to cross-link with the base fabric for good adhesion. Rubber technology is a whole science in its own right with many different types of rubber and their variants plus the art and technology of compounding. Table 9.3 shows the main products used in transportation together with the polymers used.

### 9.4.3 Direct coating

Coating is essentially spreading a polymer in the form of a thickened aqueous dispersion or an aqueous or solvent solution on to a fabric to form a continuous layer. It is necessary to thicken the liquid so that it does not sink into or through the fabric. The simplest method is the so called ‘floating knife’ or ‘knife over air’ technique where the fabric is stretched flat to form an even uniform surface and moves under a doctor blade. As the fabric moves forward, the knife scrapes the fabric surface and the polymer resin or compound is spread evenly over the fabric surface. This method is also referred to as the ‘direct method’. The amount of polymer applied, the ‘add-on’, depends on the concentration of the dispersion or solution – this is the so called ‘solids content’. The add-on is also influenced by the knife profile and angle and also fabric tension which determines the intimacy of contact with the fabric. A thick profile produces a higher add-on than a thin, sharp one; a blade angled forwards will tend to increase add-on compared to a perpendicular blade. A thick or angled blade however will tend to drive polymer into and possibly through the fabric which will cause stiffening and possibly loss of tear strength.

The knife on air method is important because the first layer of many coated products, is applied in this way. A quality base layer is especially important because it determines polymer–fabric adhesion and has a significant effect on coated fabric handle if this is important. Higher levels of application are then possible in second or third coats by supporting the fabric either by a table (knife over table) or by a roller (knife over roller). In these cases the knife does not actually touch the moving fabric, but is separated from it by a small gap set by use of a feeler gauge. The limiting factor governing the amount of compound that can be applied in one layer

Table 9.3 Summary of polymers used for fabric coating in transportation

	Properties/advantages	Disadvantages	Typical products
PVC	Inexpensive, versatile – can be compounded to give wide range of properties, good FR properties; good oil, solvent, and abrasion resistance; weldable for water-tight seams. Plastisols and water-based available	Cracks when cold, plasticiser migration	Tarpaulins, coverings Seat coverings Protective clothing
Polyurethane	Tough, good extensibility, good weatherability, very good abrasion resistance. Solvent and water-based types available. Also thermoplastic grades	Some grades discolour, FR is only moderate. Some grades expensive	Aircraft life jackets Protective clothing Life rafts Lacquers for tarpaulins
Acrylic	Versatile, blendable with other polymers. Good clarity, inexpensive, good UV resistance. Solvent-based and water-based available	FR is moderate to poor unless compounded with FR chemicals	Back coating for seat coverings Lacquers for tarpaulins
Natural rubber	Good stretch and flexibility. General purpose material. Working temperatures up to 70°C. Fillers improve mechanical properties. Many grades available by compounding	Moderate sunlight and oxidative resistance. Moderate solvent resistance, and oil resistance. Flammable, needs FR fillers. Tendency to biodegrade.	Backing for carpets Escape chutes Liferafts Tyres
SBR	Similar to natural rubber but somewhat better abrasion and flexing resistance. Better resistance to micro-organisms		As natural rubber
Nitrile (acrylonitrile/ butadiene)	Very good oil resistance which increases with acrylonitrile content. Better resistance to heat and sunlight than natural rubber		Oil seals

Butyl	Very low permeability to gases, better resistance to heat oxidation and chemicals than natural rubber	Seaming difficult	Lightweight life jackets Life rafts Chemical resistant clothing and coverings
Polychloroprene e.g. Neoprene (DuPont)	Excellent resistance to oxidation, oils, solvents and chemicals. Working temperatures up to 120°C. Good FR properties, versatile material	Coloration is difficult therefore usually black only.	Life rafts Life jackets Airbags Aircraft slide/rafts Aircraft carpet backing Hovercraft skirts Radome covers Flexible gangway bellow between train carriages V-belts
Chlorosulphonated e.g. Hypalon (DuPont)	Excellent oxidation, oil, solvent and chemical resistance. Generally similar to neoprene but higher temperature resistance to 135°C. Some grades, to 170°C, can be coloured		Properties generally similar to polychloroprene, used where coloration and higher temperature resistance is required
Silicone	Odourless, inert, good resistance to many chemicals and micro-organisms. Wide temperature service range -60 to 200°C	Expensive. Seaming difficult	Airbags
Fluoropolymer Viton (DuPont)	Very high temperature resistance to over 250°C. Excellent resistance to solvents, oils, oxidation and ozone	Very expensive	Oil seals Hoses, gaskets

---

is usually the drying off process in the coating machine oven. This is an important process, especially in the case of inflatables where a continuous, pin-hole-free and surface-defect-free coating is essential for impermeability and waterproofness. The first layer is generally applied at a low processing temperature, without curing or only partially curing it, so that the next coating layer will adhere well to it. Full cross-linking of all layers is only carried out after the top layer has been applied, so all layers are cross-linked together. The top layer must have good abrasion properties and a smooth non-'blocking' (i.e. non-tacky) surface. Figure 9.1 shows a sample laboratory coating machine and Fig. 9.2 shows actual fabric production.

The length and design of the drying oven are important because they determine coating speed and quality. The best results are generally obtained when the evaporating process achieved by heating is gradual, i.e. setting the first chamber of a multi-chamber oven at a low temperature, well below the boiling point of the carrier liquid, and the others at gradually higher temperatures. Too rapid drying can cause an irregular appearance, bubble holes and a generally poor result. Fabric coating has been compared to painting – the best results are obtained by several layers of low add-on rather than one or two thick layers. However, machine and operator time is expensive so a compromise is reached depending on the level of performance and quality required. Usually the first or base coat is applied by knife on air and subsequent layers by knife over table or roller if the polymer type allows. Generally only fairly tightly woven fabrics capable of being pulled flat and uniform can be coated by the direct method. Automotive car seat fabrics, tarpaulins and light-weight material for inflatables are produced in this way. Some inflatables are produced by applying many layers – sometimes as many as 20 layers – of specialist rubber polymers by the direct method. With all polymer coatings, sufficient heat is essential to fully cross-link the polymer for optimum performance. PVC does not strictly speaking, cross-link, but sufficient heat is necessary to gell the material properly, otherwise poor results will be obtained such as poor abrasion.

In recent years, solvent-based resins have been used less frequently, but certain high performance properties are still not obtainable using the alternative water-based or higher solids varieties and development by the chemical companies continues. Standard tests for all coated fabrics include polymer adhesion (peel bond), tear strength, blocking (tackiness of the top layer), resistance to delamination by flexing and where applicable waterproofness. Figure 9.3 shows a Schildnecht flexing test apparatus used to test coated fabrics for delamination. Waterproofness and other tests are sometimes carried out on material first flexed on the Schildnecht or the Crumple-Flex machine. This last-mentioned machine twists the fabric slightly at the

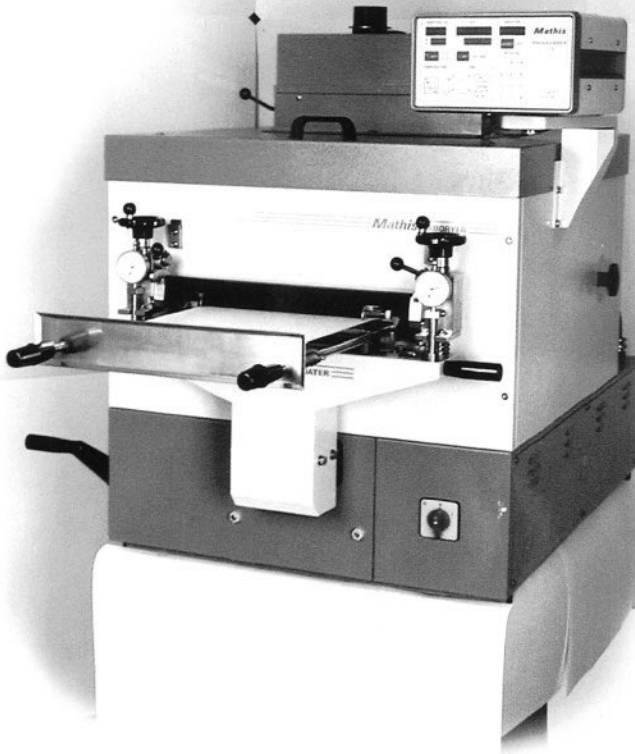

9.1 Mathis Type LTE-S laboratory development coating machine with knife on air, knife over roller and precision gap setting facilities. The oven has controls above and below air flow which can be set to any required temperature up to 200°C. Reproduced with kind permission of Werner Mathis AG.

same time as flexing and also provides a larger fabric sample for further testing.

#### 9.4.4 Transfer coating

Knitted fabrics can be coated by transfer coating which is used extensively for apparel where a good, soft handle and drape are important. Some PVC upholstery materials, especially expanded or 'blown' varieties, which have a soft touch are also produced in this way, which entails spreading the polymer first on to release paper. The top layer is applied first and then dried – but not cross-linked – followed by the middle layer, in a three-coat

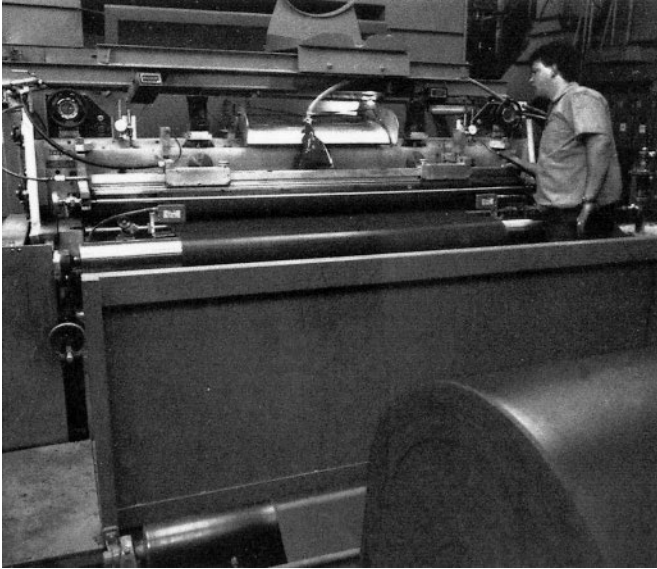

9.2 Coated fabric bulk production. Reproduced with kind permission of Reeves Brothers, Inc.



9.3 Schildnecht Flextester. Flexing is an important test for coated fabrics to assess polymer adhesion. Each fabric sample is clamped around two cylindrical holders, one above the gap and one below. The rails move rapidly up and down to flex the fabric sample. Reproduced with kind permission of SDL International Ltd.

system or the base adhesive layer, in the case of a two-layer system. The coating is dried and then the fabric is laid on top of the adhesive layer to which it sticks, and after a final cross-linking heating treatment, the coated fabric is peeled off the release paper. Decorative or embossed designs can be obtained using embossed paper or by further processing. PVC upholstery is waterproof, cleanable and flame retardant.

#### 9.4.5 Calender coating

Calender coating is used for thermoplastic polymers, which are applied by heating granules of the actual polymer. Friction of the moving rollers generates more heat, and the material is fabricated into a continuous sheet. There is no solvent or water to dry off and so high add-ons are possible. It is usual however to apply the first base layer by the direct method to obtain the best adhesion and subsequent layers by calendaring. Polyurethane, PVC and certain rubbers are applied using this method.

#### 9.4.6 Calender film lamination

Certain coverings are produced by the double-sided lamination of a very open-woven material with pre-manufactured thermoplastic films of polyurethane, polypropylene or PVC. The three materials are pressed together by a hot mangle, the two films melt and join together through the open weave of the fabric. Sometimes the fabric, more accurately referred to as a net, is not actually woven but comprises lengthways and widthways threads (or very narrow tape) locked in place by an adhesive. This material is sometimes referred to as 'weave lock' and provides the tear resistance of the material.

#### 9.4.7 Other coating methods – rotary screen

Coating of lacquers and low-viscosity resins can also be carried out using rollers in various configurations to control the add-on accurately. These include direct methods and back-licking methods. The rotary screen technique used mainly for textile printing can also be used for coating. An array of dots are pushed through the perforated screen by a squeegee bar inside the screen and centrifugal force on to the surface of the fabric, which moves at the same speed as the rotation of the rotary screen. The resin in the dots flow and merge together to form a continuous coating. This technique allows some stretchy fabrics to be coated because the resin is *placed* on to the fabric, instead of being scraped on. The rotary screen method therefore requires less fabric tension for uniform application. This method is gener-

ally restricted to water-based resins because of the problems presented by the provision of solvent wash-off facilities.

## 9.5 Textiles in other road vehicles

### 9.5.1 Commercial and goods vehicles

Commercial vehicles can be roughly grouped into four or five classes depending on weight-carrying capacity. At the lower end are estate cars and small vans which have requirements similar to passenger cars but there may only be two seats in some vans and decor may not be as elaborate as cars. Middle-sized vans such as the Ford Transit generally have only two seats but there are many variants built to order with many more seats such as those vehicles used by the police, schools and local authorities, etc. Mini-coaches have in fact been a growth area in recent years with more schools and community organizations owning their own vehicle. Table 9.4 shows volumes of vehicles weighing more than 6 tonnes gross vehicle weight (GVW) and buses. Taking 1997 as the baseline, a 38% increase is forecast by 2004.

Table 9.4 World heavy commercial vehicle sales ('000 units)

	1996	1997	1998	1999	2000	2001	2002	2003	2004
North America									
USA	359	376	424	403	370	347	365	382	398
Canada	28	34	38	37	38	39	40	41	44
Mexico	9	18	19	22	22	23	26	28	30
Total	396	428	481	462	429	410	431	451	472
Latin America	71	87	90	70	74	81	89	98	108
Western Europe	287	279	330	333	321	321	321	313	299
Germany	76	77	86	92	89	87	88	88	84
Italy	29	24	29	29	23	26	32	33	29
France	47	43	52	56	55	53	51	46	45
UK	50	46	54	51	45	48	48	51	52
Spain	22	27	30	30	31	31	29	25	21
Eastern Europe	112	127	126	126	146	182	218	240	252
Japan	89	84	66	63	67	71	75	75	75
Asia/Pacific	620	583	553	605	684	754	821	904	987
Other	37	36	40	40	43	45	46	47	47
World	1617	1631	1693	1706	1772	1871	2010	2137	2251

Source: SMMT, National Sources, J.D. Power-LMC.

Note: Heavy Commercial Vehicles include trucks of more than 6t GVW, and buses.

Reproduced with kind permission of LMC Automotive Services (Oxford) UK.

Seat fabric wear patterns can be different because with small delivery vehicles, the driver is likely to be continually stopping, getting out to make a delivery and then getting in again many times during the working day. With longer distance vehicles the driver may get out and in again only four or five times during the day. Repair engineers may be wearing oil-stained overalls and may place tools and other items on the seats.

Larger commercial vehicles and even heavy goods vehicles (HGVs) generally have only two seats and the market for seat fabric is therefore considerably less than for passenger cars. However HGVs built for long-distance haulage where the driver is away for days at a time, require higher standards of comfort and décor. They are frequently built with sleeping accommodation, curtains, carpets and textile wall coverings. The need for comfortable interiors is growing in these vehicles and more attractive, livelier colours, softer surfaces and more rounded shapes are appearing.<sup>46</sup> In the USA there is a reported shortage of drivers and comfort and pleasant cab interiors are factors in attracting and retaining drivers. Owner-operators personalize their vehicle and may install more luxury items. In addition there is a growing number of husband and wife teams requiring the comforts of home in the cab. All textiles must satisfy flammability tests set by government regulations.

Weight saving is an important consideration because an already heavy, unloaded vehicle will have less capacity available for the payload because the overall vehicle weight is limited by government regulations. Composites made using low-pressure moulding techniques are being used for exterior body panels. Composites are also being used internally as space dividers and doors, replacing more bulky and heavier material and releasing more useful storage space. Cab seat coverings are generally similar to those of car seats but sometimes tend to be made of the heavier fabrics, sometimes about  $430\text{ g/m}^2$  using yarns up to 3000 dtex with higher performance requirements of FMVSS 302 flammability.

### 9.5.2 Tarpaulins

HGVs use large amounts of tarpaulins, PVC plastisol-coated high-tenacity woven nylon and polyester fabric. Tarpaulin weights vary quite considerably from lightweight coverings weighing a little over  $100\text{ g/m}^2$  to over  $1000\text{ g/m}^2$  produced from base fabrics weighing less than  $100\text{ g/m}^2$  to over  $300\text{ g/m}^2$  with the PVC being built up in several layers usually on both sides of the base fabric. In Europe some of the highest quality tarpaulin manufacturers are members of the Complan 'club' – a quality assurance body established by the manufacturers of Trevira polyester.<sup>47</sup> The equivalent body in the USA is Isoplan-Trevira. Top quality tarpaulins are lacquered with a polyurethane or acrylic resin to improve UV degradation resistance,

improve abrasion resistance and soil-release properties and to prevent PVC plastisol migration.

Quality tests on tarpaulins include PVC peel-bond adhesion, flexing resistance, cold cracking, reduced flammability, waterproofness, tear and tensile strength, and dimensional stability over a range of temperatures and relative humidity. In addition they should be resistant to oils, engine fuels and common chemicals. Two special polyesters, Trevira HT Type 711 (Hoechst) and Diolen 174 SLC (AKZO), which are resistant to micro-organisms have been developed for tarpaulins. These are intended to overcome the problem of migration of micro-organisms into the tarpaulins via small cracks in the PVC coating. Tarpaulins must have especially good tear and flexing resistance and preferably be repairable in the field. Research continues to improve tarpaulin durability, to study mechanisms of degradation and to develop accelerated tests which reproduce conditions of wear in actual use.<sup>48,49</sup> Some non-PVC tarpaulins such as polyethylene have appeared because some pressure groups, notably Greenpeace believe PVC is harmful to the environment, especially during manufacture and disposal. Used in conjunction with tarpaulins are narrow fabric fastenings, which also need to be able to withstand UV degradation and weathering. Tarpaulins can reduce the air drag on goods vehicles, by producing smoother surfaces and fuel consumption improvements of up to 7% have been reported. More colourful tarpaulins with advertisements have appeared in the USA recently. Some analysts believe the sides of trucks on the move are areas for exploitation by the advertising industry. These have been printed and make use of up to date developments in digital printing.

### 9.5.3 Other textile uses

Flexible intermediate bulk containers (FIBCs) used for transporting powder-type materials are woven from polypropylene tape yarn and coated with a specially formulated coating. They need protection against static explosions when being filled or emptied and also require earthing with metal wire in the fabric. Recent developments have allowed the metal wire to be replaced with Negastat (DuPont), a polyester yarn which has permanent anti-static properties. Sacks produced from fabric woven from polypropylene tape yarn have significantly replaced the sisal and jute fibre sack market. This fabric is generally consolidated by curtain or extruder coating with melt polypropylene and is lighter, more chemical resistant and more durable to micro-organisms than natural fibres. This fabric – more resembling a plastic – is also used in bags and inexpensive coverings. The international sack market is estimated at about 23 billion units, 20 billion of which are made from polypropylene.

Another interesting textile application is spray guards for HGVs made from polyester monofilament yarn knitted in a spacer fabric construction about 12mm thick. They are lighter than plastic equivalents and about six are required for each vehicle. The EC have issued a directive for reduction of road spray.

Road transporters have been constructed from composites produced from Twaron (AKZO) aramid fibres by filament winding in the circumferential direction. Weight savings of 25–30% compared with aluminium have been reported.<sup>50</sup>

#### 9.5.4 Buses and coaches

Bus interiors are also becoming more attractive, welcoming and comfortable.<sup>51</sup> Wool or wool/nylon moquette fabric in generally conservative designs, seems to be the rule for many coaches and buses throughout the world. Wool is soft and warm and absorbs body perspiration without feeling damp, even in hot humid climates. Fabric weight is typically 780 g/m<sup>2</sup> after coating with acrylic latex and abrasion standards of about 80000 Martindale rubs and lightfastness to wool Blue Scale 6 are normally minimum requirements. Tear strength, dye fastness to both acid and alkali perspiration, water spotting, crocking plus soil resistance and cleanability by shampooing are other quality tests carried out. Cleaning of seat fabric is done by vacuuming and shampooing using a mild soap. The life of seating fabrics in use varies considerably depending on the volume of passenger traffic – it could be less than 6 months on busy commuter routes to over 10 years on luxury coaches. In some cities of the world vandalism and graffiti are problems and some ‘vandal-proof’ fabrics have been developed to minimize the effects – some have a pile that stands up so that if slashed with a knife the cut is not easily visible.<sup>52</sup>

Reduced flammability standards are becoming tighter, BS 5852 ignition source 5 and ignition source 7 are indicative of the standard sometimes necessary and the use of fireblockers similar to those used on aircraft (see below), are being specified more often. Similar to aircraft, the toxicity, opacity and heat flux of the burning materials are subject to examination. Tests are carried out both on the fabric alone and also on the actual seat assemblies. The new machine-washable Zirpro-treated wool developed for aircraft, see below, should find applications in buses and other forms of transport.

Composites are being used increasingly on bus and coach construction to reduce weight and thus conserve fuel. The slim-line profile of components in composites, also increase the useful carrying capacity. The benefits of the ‘stealth bus’ in California have already been mentioned.

### 9.5.5 Mobile homes

In the USA, mobile homes are a growing market especially with the affluent middle-aged groups of consumers. These vehicles are governed by safety standards and they generally need a high standard of comfort and décor.<sup>53–55</sup> Mobile homes generally have a longer service life than cars but probably less intensive use. In the UK and Europe, the caravan, which is a separate towed vehicle is preferred.

## 9.6 Railway applications

An integrated rail system is being planned for Europe and primary routes are being developed – the Channel Tunnel forms part of one. A plan comprising 30000km of new and improved lines was presented to the EU in 1989.<sup>56</sup> Rail is probably the most environmentally friendly mode of travel both for the commuter and the long-distance traveller. Increasing road congestion and traffic fumes strengthen the case for the railways and high-speed trains now compete with air for short- and medium-distance travel. Attractive decor (see Fig. 9.4) and high standards of comfort are key factors in winning passengers away from road and air travel. Details of coaching stock plus some estimate of volumes can be derived from Fox's book.<sup>57</sup> The main technical issues are reduced flammability, durability and cleanability.



9.4 Standard Class MK III, Midland Mainline coach (UK) refurbished by ADtraz (DaimlerChrysler Rail Systems). Reproduced with kind permission.

Seat upholstery, loose coverings, carpets, curtains and bedding in sleeper compartments must all satisfy stringent FR tests.<sup>58-61</sup>

Since privatization of the railways in the UK, Railtrack, the company that own the track and many stations, has prescribed performance standards, generally referred to as Railway Group Standards, with which any operators' rolling stock must comply as a condition of their use of the rail infrastructure. Textile properties including flammability standards form part of the Railway Group Standards.

### 9.6.1 Seat materials

Woven moquette fabric containing 15% nylon/85% wool weighing about 800g/m<sup>2</sup> has come to be regarded as the standard fabric.<sup>58,59</sup> This material is tested for bursting strength, tear strength, abrasion resistance by Martindale to 80 000 rubs, lightfastness to wool Blue Scale standard 6, dimensional stability and for no significant change in appearance after shampooing. In Europe, some polyester is used, especially inherently FR varieties such as Trevira CS and FR. Design patterns are usually conservative and in dark colours to mask soiling. More varied designs may be expected as the different rail companies introduce their own corporate colours.

BS 6853 1987 'Code of Practice for Fire Precautions in Design and Construction of Railway Passenger and Rolling Stock' is the guiding standard for FR properties, which also include requirements for smoke and toxic fumes assessment. Fabrics are tested singly and also in the made-up seat form using BS 5852 crib 7 and fireblockers are being increasingly required.<sup>59,60</sup> The control of smoke and toxic fumes is especially important in trains which pass through tunnels, especially single track tunnels similar to the Heathrow link. Materials, which release toxic fumes on combustion such as modified acrylic fibres and PVC are not used in passenger rail coaches.

All international passenger trains must comply with the International Union of Railways specification UIC 574-2 DR. The building of the Channel Tunnel means that certain British trains must comply with Continental regulations such as the French standard NF F 16-101 which contains detailed procedures for the testing of individual materials for FR properties including smoke opacity and toxicity. There are many different standards across Europe which are now being standardized.

Train interiors suffer from graffiti and vandals and some fabric designs are intended to minimize the visual effect of graffiti. In some Continental cities metal wire is used beneath fabrics to reduce damage by knife slashing. Some fabrics have been specially developed to minimize the visual effect of slashing with a knife. A new cut-resistant polyester fibre (CRF), developed by Hoechst Celanese, but now sold by AlliedSignal, should find

applications in public transport. CRF is a bicomponent polyester fibre embedded with ceramic platelets to deflect cutting edges.

### 9.6.2 Other rail uses of textiles

Rail carpets are important items of comfort and decor but must be extremely hard wearing and capable of withstanding high volumes of foot traffic of up to 20h every day.<sup>62</sup> Wool and nylon are the two fibres most used, but they must be treated to pass FR tests for spread of flame, (BS 476 Part 7), for smoke emission, toxicity of fumes and heat release (ASTM E 648). Wool has the better FR properties but nylon is better for soil release and cleanability. Durable antistatic properties are a requirement and this is sometimes obtained using small amounts of conductive fibres in the carpet such as Resistat (BASF) and Antron P140 (DuPont). Rail curtains and sleeping compartment textiles all need to have FR properties. The concertina or bellows-like material, which covers the space between carriages is coated nylon or polyester coated with neoprene, which remains flexible during the coldest winters.

The use of composite material both in interiors and exteriors is increasing to reduce weight in long-distance high-speed trains, which now compete with aircraft. The French advanced train TGV capable of speeds of 300 km/h contains very significant amounts of carbon fibre/epoxy composite. Nomex is used as insulation in some high-speed trains' transformers resulting in weight savings of half a tonne. Light-weight ceiling panels, satisfying the German FR standard DIN 5510, made from Nomex and glass/phenolic composites are used in some continental city trams, Cologne for example. Nomex honeycomb composites are extensively used in the interiors of trains including 'Le Shuttle'.<sup>63,64</sup> The use of composites in place of metals in European passenger trains is expected to grow by 45% in the period 1997 to 2002 according to a study by EuroTrends Research. The EC have funded research work on composites for rail applications.<sup>65</sup>

## 9.7 Marine applications

In ships and boats, textiles are again used as a means of decor and comfort. There is also a growth in composites being used in the structure of vessels especially in sports and smaller vessels including pleasure craft. Fibres are used in sailcloth, ropes, boat coverings, awnings, flags and bunting and safety equipment including life jackets and inflatable life rafts. Reduced flammability is again of paramount importance because of the restrictions on escape routes at sea and also because it is believed low ceilings and narrow corridors in vessels, increase the tendency for people to panic in the event of a fire. The 'marine area' is growing with increased affluence in countries

of the developed world – already a high proportion of families own pleasure craft in Scandinavian countries. In addition holidays on cruise ships is already a growth area in the leisure industry with several luxury cruise ships larger than the *Queen Elizabeth II* in service and several more under construction or being planned that are larger than 100 000 tons and capable of accommodating over 3000 passengers. Safety procedures and standards are being reviewed following a recent incident, which required evacuation of a new large cruise liner. Although everyone was safely taken off, the time taken to achieve this, was twice as long as the 30 min required by safety regulations, even though the ship was not full to capacity. This highlights the fact that the very large modern passenger ships are presenting new challenges and situations of which there is no previous experience.

### 9.7.1 Furnishing fabrics

The International Maritime Organization has set international standards for safety such as the IMO Resolution A471 (XII) for fire resistance. Cruise ships are really floating hotels and all furnishing fabrics must be of ‘contract standard’ generally with increased FR standards.<sup>66–70</sup> Pyrovatex-treated cotton is used and more use is being made of special grades of textiles such as Trevira CS and Fidion polyesters which have permanent FR properties that are not reduced by multiple washings. FR tests required include DIN 4102 class B and BS 476 paragraph 6. Carpets have a special function on passenger ships because of their noise and vibration absorbing properties which produces a much more pleasant and comfortable atmosphere at sea. The carpet dyes must be of the highest standard of durability because areas of the ship are in use 24 h each day and cleaning must be done to tight schedules. Ferry vessels can have over 1 million passengers a year and carpets are expected to last several years. Wool carpets are Zirpro-treated for the highest FR standard and durable anti-static properties are also required.<sup>70</sup> Sometimes this is achieved by the use of conductive fibres such as Resistat (BASF) which provides permanent anti-static properties which will not wear off in a similar way to anti-static finishes.

### 9.7.2 Marine functional applications

The advantages of composites over more traditional materials are easy handling, corrosion resistance and lower maintenance charges.<sup>8,9,71</sup> In some cases metal cannot be used, for example, in minesweepers, sonar domes and in cargo ships carrying certain corrosive materials. In addition composites are being increasingly used for navigational aids such as buoys. An advantage here is that no damage is caused in the event of a collision. Many small craft such as patrol and pleasure boats are made from glass-reinforced plastic but some polyester fibre is now being used in place of the more costly

glass fibre. At the other end of the cost scale Kevlar is also used in combination with glass fibre in small vessels. Recently a new generation hovercraft has been designed making use of Kevlar 49 composites in place of aluminium. Advantages include lighter weight, corrosion resistance, less noise in operation, better shock absorbency and higher abrasion resistance to rocks and sand surfaces.

Coated woven nylon is used for life rafts, buoyancy tubes, canopies and life jackets. Polymer coatings are butyl rubber, natural rubber, polyurethane and polychloroprene and total weights of the coated fabric are between  $230\text{ g/m}^2$  up to  $690\text{ g/m}^2$ . Quality tests include hydrostatic head to ensure waterproofness carried out after ageing and after flexing, coating adhesion, breaking load and tearing strength tests. Life jackets are generally woven nylon coated with butyl or polychloroprene rubber to give total coated-fabric weights of between 230 and  $290\text{ g/m}^2$ . Tests for these items include assessment after immersion in water for 24h. The specifications and performance standards for life jackets and life rafts are subject to government regulations. The Underwriters Laboratory (USA), issue specifications e.g. UL 1123, Marine Buoyant Devices and UL 1180, Recreational Inflatables, which are available for purchase, and specifications are also issued by the military in various countries. Finally all marine vessels use large amounts of material such as fibreglass, for vibration, thermal and noise insulation, especially in and around turbines and engine rooms.

### 9.7.3 Sails and ropes

Sail design is quite a complex subject; the main requirements are high strength, UV resistance, resistance to water and micro-organisms, light-weight properties, low creep and minimum distortion. Natural fibres, such as sisal were first replaced with nylon and polyester, which were both lighter and stronger and had better resistance to rotting. In addition polyester especially has better light and UV resistance than nylon and because of this has become more often used. The woven polyester sail fabric needs to be wet processed and if necessary, dyed using pressurized jig-dyeing machine to prevent formation of creases. Relaxation during wet processing and stentering reduces porosity by closing up the fabric structure. Modern sails, especially in racing yachts now use aramid and carbon fibres strands to combine lightness with strength.<sup>72</sup> Aramids however, are not especially UV resistant and the ultra high modulus (UHM) polyethylene yarns Spectra (AlliedSignal) and Dyneema (DSM) are now also used. Many light-weight sails are laminated materials where film is bonded to the fabric.

The new UHM polyethylene yarns have found applications as extremely strong marine ropes, which are lightweight, and have the useful ability to

float in water. One method of expressing the strength of ropes is the 'free breaking length', which is the theoretical length at which a rope breaks under its own weight. For steel rope the length is 25km, for polyester and nylon, the length is 85km, for carbon fibre it is 195km and for aramids it is 235km. The figure for Dyneema is quoted as 330km.<sup>73</sup> The material is also claimed to have very good resistance to UV light and is also resistant to acids, alkalis and solvents.

Marine vessels, especially those with sails, use considerable amounts of rope and weight saving by taking advantage of lightweight materials is a considerable advantage. Other important requirements of rope material are excellent abrasion, UV and light-degradation resistance, low moisture absorbency and of course high strength.

## 9.8 Textiles in aircraft

Interior design in aircraft is assuming more importance to make them more welcoming and passenger friendly, see Fig. 9.5. Competition with an increasing number of airlines, and with other forms of transport, make this now more essential. This will not only mean more pleasing fabric patterns but also more head room and rounder and softer surfaces to give the impression of increased spaciousness.<sup>74-76</sup> To increase safety, research is being conducted to make seats stronger, but with thinner profiles for increased space, and bulk-head airbags may be introduced. However, the main impetus for textile development is safety through more satisfactory flame retardancy and weight saving. Statistics also show that 25% of all deaths in aircraft disasters are associated with fire.

The number of planes built in a year is tiny compared with the automotive industry – very many more cars are built in the world in a single day than all the aircraft built in a year. About 500–600 large civil aircraft are constructed in a year, 75% of them in the USA and 25% in Europe. About 250 smaller planes, 1300 light aircraft and 1500 helicopters, all for civil use are also made every year.<sup>52</sup> The average life of an aircraft is 30 years and so the numbers are increasing steadily. Furnishings are replaced on a regular basis or when there is sign of wear. Aircraft production is believed to have peaked during 1999 with about 620 made in the USA and 300 in Europe.<sup>77</sup> There are an estimated 12000 civil aircraft, capable of carrying at least 60 passengers, in the world at present.<sup>78</sup>

### 9.8.1 Furnishing fabrics

Collins and Aikman in the USA together with the Douglas Aircraft Company are credited by some writers with producing in 1941 the first fabrics specifically designed for use in aircraft.<sup>79</sup> Previously ordinary



9.5 Upper class aircraft seating. Reproduced with kind permission of Virgin Atlantic Airways Ltd.

fabrics and carpets were used, but the aircraft company realised the wisdom of lighter materials and Collins and Aikman achieved significant weight reductions without loss of durability or performance. Seating fabric was reduced in weight by 41% and carpets by 31%. The new fabric, a worsted Bedford cord was soon adopted by all three armed services and contributed to the war effort. After the war, the fabric was adopted by the American civil aircraft companies.

Modern furnishing fabrics include, not only seat covers and carpets but also curtaining, headcloths and on long-distance flights, blankets and pillows. Each airline has its own livery colours, sometimes with logos. A vital factor associated with aircraft is reduced flammability of textiles and in fact of everything else on the plane. Aircraft carry huge amounts of highly flammable liquid fuel and also in the event of any incident involving fire, there is very limited means of escape – especially in the air! Seat covers need to be flame retardant but a fire barrier, made from material with very high inherent flame-retardant properties, over the seat foam is also sometimes

necessary to prevent the foam catching fire and the seat as a whole has to pass very stringent tests. All materials must be flame retardant to high standards but in addition to ignition tests, the products of combustion, smoke and toxic fumes are also assessed. Research shows that many casualties in aircraft fires did not actually come into contact with flame but were overcome by fumes. In addition smoke reduces visibility and causes disorientation reducing the ability to escape. Safety standards such as the Airbus Industrie ATS 1000.001 controls smoke opacity and the concentration of toxic gases such as CO, HCl and HCN. Modified acrylic fibres and PVC have high levels of potentially toxic fumes, see Table 9.5, whilst wool and aramids have especially low levels. The physiological effects of the main products of combustion are shown in Table 9.6.

More recent work has identified the issue of heat release and Ohio State University have developed the OSU 65/65 test which requires that interior components larger than 10 inches square (25.4cm) on aircraft built after 1990 must not release more than 65 kW/m<sup>2</sup>/min during 5 min of flame exposure and the heat issued must not peak at more than 65 kW/m<sup>2</sup> at any time during the test.<sup>80</sup> Table 9.7 shows data on some fabrics. All the tests combined are expected to give passengers one-and-a-half minutes to evacuate the aircraft.

*Table 9.5* Composition of off-gases of Kevlar and other fibres under poor combustion conditions\*

	Combustion products in mg/g of sample									
	CO <sub>2</sub>	CO	C <sub>2</sub> H <sub>4</sub>	C <sub>2</sub> H <sub>2</sub>	CH <sub>4</sub>	N <sub>2</sub> O	HCN	NH <sub>3</sub>	HCl	SO <sub>2</sub>
Kevlar	1850	50	—	1	—	10	14	0.5	—	—
Acrylic	1300	170	5	2	17	45	40	3	—	—
Acrylic/ Modacrylic (70/30)	1100	110	10	1	18	17	50	5	20	—
Nylon 66	1200	250	50	5	25	20	30	—	—	—
Wool	1100	120	7	1	10	30	17	—	—	3
Polyester	1000	300	6	5	10	—	—	—	—	—

\*The sample is placed in a quartz tube through which air is drawn at a controlled flow and heated externally with a hand-held gas-oxygen torch. Air flow and heating are varied to give a condition of poor combustion (i.e. deficiency of oxygen). Combustion products are collected in an evacuated tube and analysed by infrared.

Source: Kevlar Technical Guide (H-46267) 12/92 Table II-8.  
Reproduced with kind permission of DuPont.

Table 9.6 Combustion products and their physiological effects

Product	Sources	Physiological effects	
Oxygen depletion	All fires	21%	= Normal concentration
		12–15%	= Headache, dizziness, fatigue, loss of co-ordination
		<–6%	= Death in 6–8 min
Carbon monoxide	All fires (incomplete combustion)	1000 p.p.m.	= Death after 2 h
		5000 p.p.m.	= Death within 5 min
Carbon dioxide	All fires	250 p.p.m.	= Normal concentration
		5%	= Headache dizziness, nausea, sweating
		12%	= Death within 5 min
Hydrogen cyanide	Nitrogen containing polymers (nylon, wool, modacrylics etc.)	50 p.p.m.	= OK for 1 h
		180 p.p.m.	= Death after 10 min
Hydrogen chloride	PVC, PVDC fibres, neoprene coatings	10 p.p.m.	= Irritation
		100 p.p.m.	= Death within 5 min
Oxy-fluoro compounds	PTFE membranes	50 p.p.m.	= Irritation
		100 p.p.m.	= Death within 1 h
Acrolein	Polyolefins, Cellulosics (cotton)	1 p.p.m.	= Severe irritation
		150 p.p.m.	= Death in 10 min
Antimony compounds	Some modacrylics some rubber coatings, tentage	>0.5 gm/m <sup>2</sup>	= Pulmonary and gastrointestinal problems

Source: See foot of Table 9.7.

Table 9.7 Heat release rate (HRR), total heat release rate (THRR) and time to peak of heat release ( $T_p$ ) for a variety of fabrics

Fabric	HRR (kW/m <sup>2</sup> )	THRR (kW min/m <sup>2</sup> )	$T_p$ (s)
Cotton/polyester	170	53	33
Wool	117	39	24
Modacrylic	83	28	27
Zirpro Wool	64	24	25
Panox	27	15	30
Meta/aramid	13	6	40

Source: Tables 9.6 and 9.7 from Masri, M 'Survival under extreme conditions' in *Technical Textiles International* June 1992. Reproduced with kind permission.

The item requiring most attention inside the plane interior is the seat or more correctly the seat assembly, which is tested as a whole by tests such as the FAR 25.853c procedure in which a paraffin burner delivering flame at 1038°C is applied for 2 min. The average weight of the covered seat cushion must not exceed 10% and the char length must not exceed 17 inches (43 cm). All seats in every passenger aircraft had to pass this test from 1 July 1987,<sup>81</sup> and this led to the use of 'fireblockers' under the face fabric to surround the polyurethane foam cushion and shield it from flame. There are various types of fireblocker in use, depending on the degree of protection to the particular foam grade necessary to pass the test and also on weight restrictions and cost.<sup>26-29</sup> Among the heaviest is a 60% wool/40% Panox (Lantor-UCF), material, the lightest but most expensive is 100% aramid. Many other materials and combination of materials are in use and under development including, Inidex (Acordis), Polybenzimidazole (PBI-Hoechst-Celanese), and Visil (Sateri Oy, Finland), a silica-modified cellulose. In some cases the foam is sufficiently FR so that the seat assembly passes the tests without a fireblocker, but some of the higher FR grades of foam have the tendency to crumble. Seat comfort and other physical properties may also be compromised with these high FR foams. Tables 9.1 and 9.2 show values of limiting oxygen index (LOI) test results for materials used for their FR properties. LOI provides a numerical way of rating FR properties; materials with an LOI rating of more than 21% has some FR properties because 21% is the oxygen content of normal air.

All textiles used in aircraft interiors must pass stringent vertical burn tests such as BS 3119 or DIN 53906. American federal tests are influential and an internationally accepted test is the FAR 25.853b procedure which limits burning time to 15 s after removal of the ignition source and char length must not be greater than 20 cm. The seat cover however is also tested in combination with the cushion over which it is placed as described above. The seat cover fabric of aircraft seats is generally woven wool or wool/nylon blends, nylon in the warp, in the weight range of 350–450 g/m<sup>2</sup>. Some reduced flammability polyester and blends are believed to be under test or in use with the objective of saving weight and improving easy-care properties. Hook and loop fasteners are used extensively to securely fasten fabric to aircraft seats and to allow easy removal for cleaning and changing.

Quality tests include colour fastness, crocking, pilling, snagging, dimensional stability and cleanability. Wool is invariably Zirpro-treated (IWS) for the highest FR properties, which are retained after dry cleaning. Until recently Zirpro-treated wool fabric could not be washed in water which was a disadvantage because most stains are in fact water-based.<sup>82</sup> A disadvantage of dry-cleaning, is the retention of trace amounts of dry cleaning fluid in the seat fabric. Recent work has been successful in overcoming this difficulty by the development of FR treatments for wool, which can be washed

in water.<sup>82</sup> After dry cleaning (and now presumably after washing), a representative proportion of the cleaned seat covers, are tested for retention of FR properties. In-situ cleaning of seats must be done during the short time in between flights and soil release properties are important to make this as easy and effective as possible. The airlines evaluate this property by test staining with materials such as lipstick, coffee, ball point pen ink, mayonnaise and other oils. Residual stains or colour change after cleaning are assessed with Grey Scales. Antistatic properties of seat covers have been examined both for comfort but now increasingly for non-interference with electronic equipment. Anti-static finishes are used and there are some reports of conducting fibres in some aircraft seats.

Aircraft carpets, typically under  $2000 \text{ g/m}^2$  ( $62 \text{ oz/yd}^2$ ) in total weight, are generally woven loop pile wool sometimes with a polypropylene backing for economy and to save weight. The pile is locked in with FR neoprene foam or a similar FR compound.<sup>83</sup> Appearance is important and aisle carpets which are subject to the highest wear including the effects of food and drinks trolleys need to be replaced as soon as wear is evident, sometimes after 6 weeks. Other areas such as under seats, need changing much less frequently, perhaps after a year or more. The carpet is tested for flammability using tests such as FAR 25 853(b) and also for smoke and toxic gas emissions and heat release. They must be easily cleaned and contain conductive fibres together with an antistatic coating on the back for permanent antistatic properties. Some airlines require a maximum of 1000 volts in a static body voltage generation test. The carpet or indeed any other article on the aircraft must not contain any substance, which could give rise to corrosive chemicals that could cause deterioration of the aircraft's metal structure.

### 9.8.2 Fibre re-inforced composites

The importance of composite materials in the commercial viability of aircraft has already been mentioned. Composites are used in many parts of the aircraft interior and structure resulting in significant savings in weight and space. Internal space dividers are usually made from glass fibre in phenolic resin and they must also pass all the flammability tests. Phenolic resin is used because of its FR properties and low smoke and low toxicity of the products of combustion. Composite development continues apace and further weight savings and other benefits can be expected. It has been estimated that even 1 kg saving in weight in an aircraft reduces fuel costs by £150 a year. Analysts predicted that by the year 2000 civil aircraft would be built with up to 30% of their total weight in composite material – some believe it could be as high as 65%.<sup>84</sup> Already many military aircraft are produced from over 50% composite material and in helicopters the figure

could be as high as 70%. The increased use of carbon fibre, in some cases replacing glass fibre is expected to continue as carbon fibres become more available and processing efficiencies increase. Recently, researchers believe they have developed a means of containing terrorist bombs using 20 layers of AlliedSignal Spectra fibre.<sup>85</sup>

### 9.8.3 Other textiles uses in aircraft

Coated textiles are used in many safety items including escape chutes slide/rafts, inflatable life rafts and life jackets, see Figs. 9.6, 9.7 and 9.8. These items are generally produced from polyurethane or synthetic rubber coatings on woven nylon fabric. PVC coatings are generally avoided because of emission of toxic gases if they catch fire. Life rafts generally comprise buoyancy tubes, so that if one is punctured, the raft stays afloat. They can hold up to 30 or more persons and are covered with fabric to increase survival prospects in Arctic conditions. Life jackets are generally about 250 g/m<sup>2</sup> total weight, the polyurethane being applied by hot-melt coating over a first base layer of either water-based or solvent-based material applied by a doctor knife. They are made to the highest standards and are periodically individually checked for serviceability. Coated fabrics are used for fuel tanks in some aircraft, especially military, because they are flexible and can make use of awkward shaped spaces on the plane.

Seat belts are usually woven polyester at present lap only, but there has been some discussion regarding making them more like car seat belts with three anchoring points. This would more than double the amount of material required. Airbags for head protection have also been discussed but so far have not appeared in civil aircraft. Finally there are quite sizeable



9.6 Aircraft evacuation slide. Reproduced with kind permission of Reeves Brothers, Inc.



9.7 Defence Aviation Liferaft MS.33 for 33 persons produced from butyl rubber sandwiched between two layers of heavy duty nylon fabric. Reproduced by kind permission of Beaufort Air-Sea Equipment Ltd.

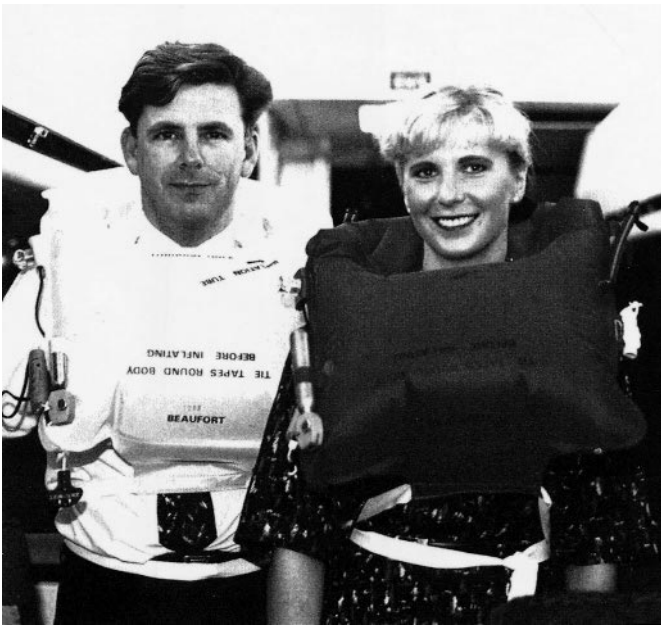

9.8 Beaufort Lifejackets are light and compact in storage. In use, they are designed to turn the wearer whether conscious, or unconscious to the correct angle of flotation with the nose and mouth held clear of the water. Courtesy of Beaufort Air-Sea Equipment Ltd and reproduced with kind permission.

volumes of non-woven fabric being used as disposable head cloths on seat backs.

Mention must also be made of the use of fabric in hot-air balloons and airships, which some writers believe could play a significant part in cargo transport in the future. The German government is supporting construction of freight airships and a German firm is reported to be building airships for the tourist industry. Strength-to-weight ratio, UV degradation and hydrolysis resistance are amongst the important requirements. Coated fabric and fibre composites are likely to be extensively used.

## 9.9 References

1. Anon, 'Composites growing by 10% pa', *PRW*, 29 January 1999.
2. Summers CB, 'Transit agencies position for the inside track', *Automotive & Transport Interiors*, April 1995, 36.
3. Svensson N, 'Textile structures for load-carrying composites', *Textiles* 2 1998, 6–13.
4. Kirk Othmer, 'Composite Materials – Survey', *Encyclopaedia of Chemical Technology*, 4th edn. New York, John Wiley, 1993.
5. Modern Plastics Magazine, *Encyclopaedia Handbook*, 1994, USA, McGraw Hill, 124–36.
6. Eaton PM, 'Fibre reinforced composites' *Textiles* 1986, 15 (2), 35–8.
7. Angelin JM, 'Aircraft applications (of composites)', *Engineering Materials Handbook*, Vol. 1, Metal Park, OH, ASM, 1987, 801–9.
8. Summerscales J, 'Marine applications (of composites)', *Engineering Materials Handbook*, Vol. 1, Metal Park, OH, ASM, 1987, 837–44.
9. Pinzelli RF, 'Use of composites in maritime structures,' *Techtextil*, 14–16 May 1991, Frankfurt.
10. Drechsler K, 'Needs of the transportation industry regarding fibre composite products', *INDEX 99 Congress*, Geneva, 27–30 April 1999, Brussels, EDANA.
11. Wilks CE, Rudd CD, Long AC & Johnson C, 'Textile reinforcement for automobile composites', *World Textile Congress*, Huddersfield, July 1998, Huddersfield University, 1998.
12. Eaton PM, 'Aramid Fibres' *Textiles*, 1983, 12 (3), 58–65.
13. Grand JA, 'High tech bus draws heavily on aerospace technologies', *MPI*, February 1997, 30.
14. Anon, 'Toray expanding PAN-based carbon fibres', *JTN, (Japanese)*, September 1996, 107.
15. Anon, 'Technical Textiles', *Knitting International*, June 1996, 103 (1227), 38–9.
16. Khokar N, 'An experimental uniaxial 'Noobing device', *Textiles Magazine*, 1996, 3, 12–14.
17. Hearle JWS, 'Textiles for composites', *Textile Horizons*, December 1994, 14 (6), 12–15 and February 1995, 15 (1), 11–15.
18. Anon, 'Global report – the Americas', *MPI*, February 1998, 12.
19. Horrocks AR, 'Flame retardant finishing of textiles', *Review Progress Coloration*, 1986, 16, 62–101.

20. Roberts DL, Hall ME & Horrocks AR, 'Environmental aspects of flame retardant textiles – an overview', *Review Progress Coloration*, 1992, 22, 48–57.
21. Sager AJG, 'Protection against flame and heat using man-made fibres', *Textiles*, 1986, 15 (1), 2–9.
22. Bagnall J, 'Testing the reaction of textiles to fire', *Textiles Magazine*, 1995, (4), 12–17.
23. Troitzsch J, '*International Plastics Flammability Handbook*', 2nd edn, IMO 844E, London, 1993.
24. Barrow CC, 'Standards for textiles used in commercial aircraft', *Textile Horizons*, April/May 1992, 30–4.
25. Benisek L, 'Burning issues – TI Flammability Conference – Salford University', *Textile Month*, July 1999, 19–23.
26. Saville N & Squires M, 'Latest developments in fire resistant textiles', *Textile Month*, May 1990, 47–52.
27. Keil G, 'Fire-blockers – a protection for passengers', *Technical Usage Textiles*, 1991, 4 (2), 46–7.
28. Garvy S, 'Visil – the hybrid viscose fibre', *Textiles Magazine*, (3), 1996, 21–4.
29. Vance PD, 'BASF fires up production of unique melamine heat resistant fiber', *International Fibre Journal*, June 1998, 60–2.
30. Paul KT, 'Flame retardant polyurethane foams furniture testing and specification', *Review Progress Coloration*, 1990, 20, 53–69.
31. Hurd R, 'Flame retardant foams', *J Cellular Polymers*, 1989, (4), 277–95.
32. Lomax GR, 'Coating of Fabrics', *Textiles*, 1992, (2), 18–23.
33. Fulmer TD, 'Coated fabric use increasing', *ATI*, June 1994, 86–8.
34. Bajaj P & Sengupta AR, 'Coated fabrics', *Textile Progress*, 14 (1), 15–26.
35. Wilkinson M, 'A review of industrial coated fabric substrates', *J Coated Fabrics*, 26 October 1996, 87–106.
36. Smith WC, 'The importance of proper fabric selection', *6th International Conference Textile Coating and Lamination*, 4–5 November 1996, Dusseldorf, Technomic Publishing.
37. Ford JE, 'Fibre and fabric substrates for coating', BTTG Symposium, Chester, '*Progress in Textile Coating and Lamination*', 2–3 July 1990, Manchester, BTTG.
38. Thomas EJ, 'Coated materials for specialized end uses', BTTG Symposium, Chester, '*Progress in Textile Coating and Lamination*', 2–3 July 1990, Manchester, BTTG.
39. Broadbent F, 'The standardisation of coated fabrics' (testing), BTTG Symposium, Chester, '*Progress in Textile Coating and Lamination*', 2–3 July 1990, Manchester, BTTG.
40. Zimmerman E, (Lindauer Dornier), 'Heavy Duty', *Textile Month*, May 1999, 69–71.
41. Woodruff FA, 'Environmentally friendly coating and laminating – developments in machinery and process technologies', BTTG Symposium, Chester, '*Progress in Textile Coating and Lamination*', 2–3 July 1990, Manchester, BTTG.
42. Weber MO & Schilo D, 'Surface activation of polyester and aramid to improve adhesion', *J Coated Fabrics*, October 1996, 26, 131–6.
43. Janssen H, (AKZO), 'Aramid fibers and new adhesion systems to elastomers, application and performance', Sixth Annual Conference on Coating and Laminating, Dusseldorf, 4–6 November 1996.

44. Tran MD *et al*, 'Surface characterisation of polymer fibres treated by atmospheric pressure plasma for enhanced wettability and adhesion', *Index Congress*, 27–30 April 1999, Geneva, Brussels, EDANA.
45. Andreopoulos AG & Tarantili, 'Corona treatment yields major advantages', *Textile Month* February 1997, 30–1.
46. Henrick M, 'Truck interiors become home from home', *Automotive & Transportation Interiors*, October 1994, 16–19.
47. Hoechst Technical Information sheet, *Trevira in focus – Complan*, 12687/98e.
48. Eichert U, 'Weather resistance of coated fabric for the automotive industry', *IMMFC*, Dornbirn, 17–19 September 1997.
49. Dartman T & Shishoo R, 'Predictions of performance of coated fabrics', *Technische Textilien*, November 1995, E43–E46.
50. 'Economy on the Road; Twaron/synthetic resin composites', *Techtextil-Telegram*, No. 36 E, 30 January 1995.
51. Moore L, 'Bus interior components softer, more flexible', *Automotive & Transportation Interiors*, April 1994, 26–9.
52. Laurent H, 'Fabrics used in transport vehicles', *Techtextil*, 14–16 May 1991, Frankfurt.
53. Dorage DC, 'Conversion vehicles; Making the most out of the road trip', *Automotive & Transportation Interiors*, November 1995, 34–7.
54. Sullivan LE, 'All things to all people', *Automotive & Transportation Interiors*, April 1998, 28–31.
55. Henricks M, 'Works like a truck, rides like a car', *Automotive & Transportation Interiors*, March 1996, 22–5.
56. Hans-Joachim F, (Deutsche Bank), 'The development of transport until the year 2000', *Techtextil*, 14–16 May 1991, Frankfurt.
57. Fox P, '*British Rail; Locomotive and Coaching Stock 1998*', Sheffield, Platform 5 Publishing, 1998.
58. Lowe EJ, 'Textiles in railways', *Textiles*, 1 (1), February 1972, 8–11.
59. Jones HR, 'Textiles in the railway passenger environment', BTTG Symposium, *Flammability*, London, 1–2 December 1993.
60. Baker-Counsell J, 'Testing for fire safety on London Underground', *PRW*, 30 January 1988, 8–9.
61. Troitzsch J, *International Plastics Flammability Handbook*, 2nd edn, New York, Hanser, 1989, 299–310.
62. IWS TI leaflet, *Wool Contract Carpets for Rail Passenger Vehicles*.
63. Anon, 'Reinforced plastics exhibit good growth in Euro rail applications', *MPI*, February 1998, 24.
64. DuPont Newsletter, '*Link*' (Kevlar/Nomex) L-10509 4/96.
65. Anon, 'Rail composites research gets EC backing', *BPR*, September 1997, 52.
66. O'Shea M, 'Interior Furnishings', *Textile Progress*, 1979, 11 1, 1–68.
67. Gurrbach U, 'Decorating ship interiors with flame retardant fabrics', *Textile Month*, April 1995, 25.
68. Hill D, 'Polyester fabrics for safer public buildings', *TTi*, July/August 1999, 25–7.
69. Lewis P, 'Polyester safety fibres for a fast-growing market', *Textile Month*, April 1997, 39–40.
70. IWS TI leaflet, *Wool Contract Carpets for Passenger Ships*'.

71. Karegeannes JG, 'Discovering and exploiting new markets for a fibre', *TTi*, May 1992, 14–17.
72. Belgrano G & O'Connell C, 'Carbon sails to the front', *TTi*, May 1992, 28–31.
73. DSM TI leaflet, '*Dyneema, Properties and Applications* 8/97.
74. Garner R, 'Aircraft interiors feel the pressure', *Automotive & Transportation Interiors*, February 1996, 12–22.
75. Smith TL, 'Fabrics and fibres review; aircraft designers go corporate', *Automotive & Transportation Interiors*, May 1995, 28–32.
76. Henricks M, 'Return of the pampered passenger?', *Automotive & Transportation Interiors*, April 1996, 48–50.
77. Anon, 'Boeing/Airbus on target for record shipment this year', *Flight International*, 14–20 July 1999, 5.
78. Anon, 'Airbus/Boeing continue to dispute sales prospect for large aircraft', *Flight International*, 30 June–6 July 1999, 31.
79. Editors of American Fabrics Magazine, '*Encyclopaedia of Textiles*', Englewood Cliffs NJ, Prentice-Hall, 1960, 569–70.
80. Bucher J, 'Regulations, economics limit plastics choice in aircraft', *Automotive & Transportation Interiors*, September 1995, 48–50.
81. Barrow CC, 'Standards for textiles used in commercial aircraft', *Textile Horizons* April/May 1992, 30–4.
82. Benisek L, 'Innovations in flame resistant wool transportation furnishings', *Textile Asia*, August 1998, 36–42.
83. IWS leaflet, '*Wool Contract Carpets for Passenger Aircraft*'.
84. Middleton DH, '*Composite materials in aircraft structures*', Harlow, Longman, 1990, 16.
85. Raleigh P, 'Composites contain airborne explosions', *PRW*, May 1997, 2.

## 9.10 Further reading

1. Adanur S (ed.), '*Wellington Sears Handbook of Industrial Textiles*', New York, Technomic, 1995, 513–22.
2. Barden B, 'Coated Fabrics', *Kirk Othmer Encyclopaedia of Chemical Technology*, 4th edn. Vol. 6, New York, John Wiley, 1993, 595–605.
3. Chou T-W & Ko FK (ed.), '*Textile Structural Composites*', New York, Elsevier, 1989.
4. DETR (Government Publication), '*Transport Statistics, Great Britain 1999*', London, 1999.
5. Fox P, '*British Rail; Locomotive and Coaching Stock 1998*', Sheffield, Platform 5 Publishing, 1998.
6. Hearle JWS, 'Ropes and cordage 2 – Fifty years of change', *Textiles Magazine*, 1, 1999, 9–15.
7. 'High Performance Fibres, Textiles and Composites', UMIST Symposium 25–7 June 1985, Manchester, Dept of Textiles, UMIST.
8. Horrocks AR, Tunc M & Price D, 'The burning behaviour of textiles and its assessment by limiting oxygen index methods', *Textile Progress Series*, 18/1/2/3 The Textile Institute, 1986.
9. International Maritime Organization, '*Fire Test Procedures*', 2nd edn IMO 844E, London, 1993.

10. Ko FK, Brachos V, Rossi G, Balonis RJ & Van Vuure AW, 'An all-composite electric vehicle', *Textile Asia*, February 1999, 25–9.
11. Matthews G, 'PVC – Production, Properties and Uses', London, Institute of Materials, 1996.
12. Middleton D (ed.), 'Composites Materials in Aircraft Structures', Harlow, Longman, 1990.
13. Mohr JG & Rowe WP, 'Fibre Glass', New York, Van Nostrand Reinhold, 1978.
14. 'Modern Plastics Encyclopaedia Handbook', Edited by Modern Plastics Magazine, New York, McGraw-Hill, 1994.
15. Progress in Textile Coating and Laminating, BTTG Symposium, 2–3 July, Chester, 1990, Manchester, BTTG.
16. Risato DV, 'Plastics Processing Data Handbook', 2nd edn London, Chapman & Hall, 1997, 500–51 (Composites Reinforced Plastics).
17. Smith LP, 'The Language of Rubber', Oxford, Butterworth Heinemann with DuPont, 1993.
18. Technomic Publishing (Journal of Coated fabrics), Annual Conferences, *Textile Coating and Laminating*, from 1990 onwards, Lancaster PA (USA) & Basel, Switzerland.
19. Troitzsch J, 'International Plastics Flammability Handbook', 2nd edn, New York, Hanser Publications, 1990.
20. Wypych J, 'Polymer Modified Textile Materials', New York, John Wiley, 1988.

### 10.1 General survey

The two main factors likely to continue to influence research and development in the automobile industry for the foreseeable future are, the environment and the control of cost. The textile industry can contribute to the environment by introducing lighter weight fabrics and devising ways of facilitating recycling of car components. Textile recycling poses a challenge because the textile face fabric is usually inseparably joined to another material, which is generally chemically dissimilar. The use of a textile to replace this other material to help reduce the number of chemical types and hence facilitate recycling, presents opportunities. However the most significant way in which textiles are likely to contribute to a better environment is via composite materials which replace heavier metals and significantly reduce the weight of road vehicles. Cost is being driven down by commercial factors, such as company mergers, joint ventures and the economies of large-scale production and purchasing. Technology is contributing by development of novel production methods, which combine two or more processes into one. These new techniques, which increase efficiency also reduce human error and provide more consistent quality, will continue to be developed and improved. New high-performance materials being developed by fibre and chemical companies, such as the ultra-high-strength polyethylene fibre and the thermoplastic polyolefin foils, present further opportunities to innovate in both products and production techniques. Advances in information technology and communications are also contributing to reduced costs and better efficiency.

A third factor driving development in the automobile industry at present is safety. Safety features represent the biggest single growth area in technical textiles at the present time but they add to the cost of the car. However OEMs in the USA in particular have no choice, because they are a requirement of federal law. Developments in the USA influence practice in the rest of the world, especially in the global automotive industry and airbags are

becoming standard features in European cars, even though at the moment, legislation does not make them compulsory. There is opportunity for substantial growth in side-impact safety devices world-wide. Side-impact devices are already in new cars in the USA but protection for the 'full continuum of passengers' is likely to become a further requirement of US federal law. This means effective protection for a whole family of two adults and three children.

Road safety is becoming an important issue all over the world and we can expect more concerted efforts to improve the present situation. As previously mentioned, over half a million persons are killed on roads world-wide and a further 15 million injured and a significant increase in these figures is anticipated as developing and emerging nations use more cars and the young populations of the world grow to adulthood. We can expect more legislation and the development of more advanced safety features.

Product innovation will continue to play a very important role as OEMs compete to provide better value for money and gain sales advantage by offering something different and more advanced than their competitors. This is no easy task because of the extremely high requirements of product durability not to mention the ever present restrictions of tight cost control, which make the acceptance of additional products or features by the OEMs very difficult. However technical advancement is inevitable not only in the automobile industry but in every department of human activity. Technical advances in other industries will influence developments in the automobile sector, for example the development of synthetic fibres and advanced composites, while product development specifically tailored for the motor car will continue, because of the high volumes and potential reward.

Mobility is essential for all human activity, in both work and play, and cars embody personal freedom and individuality. Despite rising costs and increased road congestion it is unlikely that in the developed world people will be willing to give up their cars. In the developing countries people who can afford cars, own cars and most persons who cannot afford them at present, will almost certainly buy when their financial resources allow. Motor cycles crowd the streets of developing nations in South-east Asia and in the not too distant future these will be replaced with cars. The industry is set to continue to grow for the foreseeable future. This will happen despite a huge manufacturing overcapacity in the world – although some analysts take the view that there is a shortage of efficient manufacturing plant.

Car ownership is approaching saturation in the developed world but there are at present opportunities in South America, Eastern Europe and South-east Asia. There are even greater opportunities in the more distant future in China, India, Africa and Central Asia. All of these developing and new markets with their own cultures, historical backgrounds and heritage will come with their own particular technical requirements and especially

interior design preferences. An example is the Ford Ikon specially designed for the Indian market, which has extra leg room in the back because many Indian car owners employ chauffeurs and also extra powerful air-conditioning for the hot weather. One report claimed that head-space in the back was checked to ensure that a person wearing a turban could be comfortably accommodated.<sup>1</sup>

## 10.2 Manufacturing

New products and new manufacturing techniques lead to new test methods, and many demand higher standards of acceptance in existing tests. New materials although well suited to a particular application, may face unnecessary delays in acceptance because the product specifications are written around existing materials or processes. Some of the specification requirements may be too severe and some, not entirely necessary. Innovators must therefore have the determination to convince potential customers of the benefits of a new product or process. Anything new, must justify the sometimes lengthy task of rewriting standard operating procedures and other quality documents. Newer and more efficient production methods can take a considerable length of time before acceptance on a wide scale.

The industry is understandably cautious, because despite intensive testing and product evaluation, new products can still give problems or break down prematurely when used by the consumer. This can be extremely damaging to sales of an otherwise excellent vehicle and to the reputation of the OEM. In addition a new process or product may require new tools, new apparatus and new procedures using innovative but still to be proven technology. New tools or plant can be expensive and always presents a certain amount of risk. New products have a much better chance of acceptance if they can be produced on existing equipment or presented when existing plant is nearing the end of its life and will have to be replaced in any case. Cost reduction is the main driving force at the present time and innovative features with real benefits may not be considered purely because it will add to the overall cost. Other developments may not be given the opportunity of even being presented, because the decision-makers are too busy with the pressures of day-to-day tasks. These factors, although understandable, can be discouraging to research and development workers in university and company laboratories. Some ideas may never be given an opportunity because innovative research and development staff in a supplier company may have no access to their counterparts in a customer company who may be receptive to new thinking.

Nevertheless the industry leaders call for more creativity, imagination and new thinking but changes still take place slowly because of the reasons mentioned. In addition some analysts maintain that there is some unrea-

sonable reluctance to change and believe that the most innovative changes could well first appear in a developing country where there is no existing plant to replace and there are no rigid thought patterns to overcome. Some very novel labour- and material-saving processes such as 3-D knitting of car seats still await large-scale adoption.

Fabric production, dyeing, finishing and lamination have become substantially more efficient over the last 20 years or so. The concept of 'blind dyeing' would have been thought impossible and quite reckless in the 1970s but the introduction of the computer and better and more precise control of parameters influencing dye uptake has made this quite normal procedure. One task still carried out very much the same as 20 years ago is final fabric inspection. Inspection table design has improved but operatives capable of human error and with human limitations still perform this important but relatively tedious and repetitive job. Technology does exist, in theory at least, to automate this process and reduce the number of defects being passed to the customer, but the breakthrough of making it affordable is still to be made. However, final inspection, no matter how efficient or automated, cannot correct faults once they have been introduced. The concept of zero defects continues to be the ultimate goal and is encouraged as a target for all the individual processes along the production chain.

### 10.3 Fabric performance

Automotive textiles are still in their infancy compared to clothing and there are many developments which could be applied to car interior trim but which the limitations of durability and cost at present rule out. The surface touch of car seats is generally rough and even abrasive compared to the latest 'peach skin' tactile properties of clothing. However fabrics with softer touches made from cellulosic materials such as Tencel would fail abrasion tests by very large margins. The use of cellulosic fibres in polyester blends, in optimized constructions with engineered yarns might lead to abrasion properties approaching automotive standard. If this became possible, the benefits could include improved thermal comfort as well as softer handles.

The garment industry is exploring ways of offering more 'customization', i.e. allowing the customer to choose garments made to exactly the correct size, and produced in his or her own design and colour in any fabric construction. Some analysts believe the success of this is necessary for survival of the garment industry in developed countries. The customers' own designs could be communicated directly to fabric production plants (3-D knitting would be ideal for this concept) or printing plants via the internet. Could this degree of individuality ever become viable in the automotive industry? We have perhaps seen the beginning of this new concept with the launching of a car which has changeable exterior panels – the Swatch/

Mercedes mini car. Also some vehicles such as the multi-purpose vehicle (MPV) now offer the facility of altering the seat layout and even removing seats altogether. This could eventually lead to a replacement seat market which might tolerate slightly lower standards of performance. This would make possible many fabric developments, at present not viable because of the very high standards of durability demanded by the OEMs for car seat fabric, which is fixed in place for the life of the car.

The general feeling, however, is that fabric performance requirements are likely to be raised even higher, especially in the USA. Recent analyses showed that the average car being made now will still be on the road in 17 years' time. Having said this, certain researchers hold the view that some durability requirements are not entirely realistic. For example the abrasion properties required for door casing fabric is frequently the same as the high standard specified for seating. Areas close to door handles certainly need good durability, but some other areas of the door casing are rarely touched.

Throughout the developed world, population patterns are changing and the next century will see significantly higher numbers of retired people who are living longer. Will they want to hold on to their cars for longer – or will some want to change even more frequently because they still have more money to spend? In the USA more pick-up trucks than cars were sold during some years of the late 1990s. These are advertised as robust vehicles and are likely to be treated as such. In addition, in the USA more and more cars are being leased and so the car's private life does not begin until it is sold after perhaps 2 or 3 years. An interior in excellent condition is essential for a good resale value because most people are not mechanically minded. If the interior appears worn and badly maintained they will assume the rest of the car is the same. Changing attitudes, lifestyles and social patterns need to be monitored and studied for possible effects on car interior requirements.

## **10.4 New developments and opportunities**

Increased living standards, larger disposable incomes and higher 'quality of life factors', are likely to create higher expectations of quality and of comfort in all its forms. Softer handle, more thermal comfort – less sweating in hot weather, more effective soil resistance and better cleanability are all opportunities for fabric technologists. Increased hygiene awareness and attitudes could make the last-mentioned factor more of a requirement. Car seat fabric is fixed in place and not thoroughly cleaned during the life of the car; one researcher compared this to not changing our clothes for 40 consecutive days! The problem of odours and air pollution from external sources is being addressed with increased installation of cabin filters using activated carbon. However the public is now also more aware of odours

from inside the car, especially in new cars and this is leading to revised manufacturing procedures. The Ford requirement for suppliers to be equipped with an electronic nose could spread to other OEMs. Associated with odour is the possible use of anti-microbial finishes or fibres with permanent built in anti-microbial properties, such as Amicor (Acordis) and Bactekiller (Kanebo). These materials could be especially useful for the car seat fabric and the carpet. More food and drink is being consumed inside cars, especially the MPV – certainly more cup holders are appearing in vehicles – and spillage is likely to become more common. One novel invention which does not appear to have been widely adopted is the odour-absorbing back-coating on car seat fabric – possibly further development is required.<sup>2</sup>

Textiles are already in most areas of the car, but it has been suggested that opportunities still exist for further usage in dashboards, door and seat pockets, seat backs and sunvisors. A new generation of fibres by biological synthesis is likely to appear in the new millennium, which could provide the world with ‘super-fibres’ with virtually any property or combination of properties required.<sup>3,4</sup> The new methods of polymer synthesis could combine at present seemingly paradoxical properties e.g. softness with high abrasion resistance and significant moisture absorbency, of fibres with improved thermal comfort allied to the durability of polyester. Use could be made of the phase-change temperature-regulating materials to further enhance thermal comfort.

Possibilities do exist for innovation and to offer something new or different – or simply to keep up with the competition. In addition to up-to-date, attractive, novel and imaginative fabric designs are the following desirable properties: higher standards of cleanability; ‘lint’ resistance; anti-microbial finishes/anti-microbial fibres; better thermal comfort; anti-static properties; softer ‘touch’ fabrics; easily replaced seat covers; and fewer odours.

## 10.5 Environmental issues

Public opinion and attitudes have gradually changed over the last decade or so and the effect of human activity on the environment is now taken very seriously. A new generation has grown up educated in environmental issues, the Green Party are in office in the European Parliament and every country has a senior minister responsible for the environment. Companies want to be recognized as environmentally responsible organizations and many are already registered with ISO 14001. Regular world summits are held on the environment and countries are expected to contribute to conservation of world resources and to protect the planet from ecological disasters such as global warming. In Kyoto 1997, the European Union representatives undertook to reduce carbon dioxide emissions over Europe and in turn the EU

requested the European automobile industry to play its part. Furthermore, legislation has been passed which will have wide-ranging and significant impact on the automobile industry. Thus the industry is under pressure from all sides, the general public, local, national and EU government to protect the environment. The car however is here to stay but its use could well be restricted by governments of the world in sustainable transport systems.<sup>5</sup> Air pollution apart, there simply will not be enough road to accommodate all future cars.

European OEMs have voluntarily agreed a 25% reduction in car exhaust emissions in new cars by 2008, taking 1995 as the baseline.<sup>6</sup> This will mean an average of 140g of carbon dioxide emitted per kilometre. Some cars achieving 120g/km will be available by 2000 and the position will be reviewed to take plans beyond 2008.<sup>7</sup> Zero emissions is the ultimate target for OEMs and very soon Japanese made 'hybrid vehicles', partly electric and partly petrol driven, will appear on the roads in Europe. For some time now, alcohol-powered vehicles and cars running off propane have been used in some countries of the world.

Emission reduction will be achieved by cleaner engines but OEMs are also striving to make cars as light as possible to obtain more mileage per unit of fuel. Fibre composites, competing with aluminium are likely to play a major role here and it is only a matter of time before the problems associated with high volume production of large car panels in composites are resolved. Carbon fibres may even eventually appear in the bodywork and structure of regular production cars, probably first in up-market models. A South African company, Aerotek has developed a racing motorcycle wheel using carbon fabric prepregs, which is about half the weight of a conventional cast wheel.<sup>8</sup> Specially designed composites are contributing to safety by dissipating crash energy more effectively to protect the car occupants. The science of composites is still in its infancy compared with metal processing with over a century of accumulated know-how. Already all-plastic concept car bodies have appeared composed of only several pieces of plastic compared to innumerable pieces of metal.

The EU Directorate making OEMs responsible for the disposal of ELVs, which has just been approved by the European Parliament, will have wide-ranging effects. It will certainly hasten changes in the design of cars specially for recycling because the cost of scrapping an ELV is estimated at about \$200 per car.<sup>9</sup> In the UK alone this will amount to £300 million every year.<sup>10</sup> As far as fabric producers are concerned, the landfill restriction aspects loom in the distance and there may not be too much pressure for maybe 2 or more years. Even by 2015, 50kg of an average car weighing one tonne, can go to landfill, and so in theory all the textile material could be disposed of in this way. However textiles in the car are joined inseparably, to other materials and the whole component, e.g. a headliner weighs much

more than the fibre alone. OEMs and the auto industry will expect everyone to contribute and the 5% landfill allowance is likely to be needed for other items which are impossible to dispose of in any other way. Incineration with energy recovery is a possibility but any combustion process inevitably produces carbon dioxide, a global-warming gas.

Ford in 1993 stated that for a part to be considered recycled, it must contain at least 25% recycled material.<sup>11</sup> In the UK, the British Plastics Federation and the Consortium for Automotive Recycling (CARE), have very recently introduced the first generic recyclate standard.<sup>12</sup> The objective is to encourage and promote the use of recycled material in automobiles. This first particular standard, relates to a mineral-filled polypropylene, which must contain a minimum of 25% post-consumer-sourced recyclate. Three car makers, Ford, Nissan and BMW have already endorsed it. More recyclate standards are to follow and eventually it is hoped that all car makers will adopt them. There could conceivably be, at some time in the future, a similar standard for recycled textiles. Efforts will continue to find ways of recycling automotive textiles and also to use recycled textiles in the car. In addition, thought will continue to be given to use as few polymers as possible to facilitate dismantling.

More consideration needs to be given to the concept of temporarily joining materials together via some mechanical means, or using a measured amount of adhesion, sufficient to hold components together for the life of the car, but allowing relatively easy separation at the end of the car's life, e.g. the Crea Tech Process. Recently, industry in the USA organized a competition for young designers to produce a car seat which could be easily disassembled for recycling.<sup>13</sup> Meanwhile development continues apace to find more environmentally friendly materials and methods. Biodegradable composites, using natural fibres to replace fibreglass in plastic moulding processes are being researched and these are finding applications in cars.<sup>14</sup> Much positive, useful publicity and public respectability could be gained by the OEM and anyone else associated with a 'green' car.

## 10.6 Visions of the future – fabric design aspects

The one requirement which can be confidently predicted to continue, will be that of design and styling, particularly of the car interior, to keep pace with the development of trends and exterior body shapes. The contribution which textile products can make to this is considerable as has been demonstrated forcibly over the past decade or so. The question is not whether this will continue but rather what textile technology will be found to be the most suitable and efficient at providing the flexibility, scope, quick response and high performance, etc. over a range of substrates to support future development requirements.

The answer to this question is not clear yet, but there are obvious advantages to be gained by having large stocks of standard fabrics which can be converted into a figured product on a short time scale once the requirement is known. Today, we consider this to be the realm of the jacquard, whether woven or knitted. Printed fabric however, can perform the task better, but until recently all printing was a contact process, which in some way altered, usually for the worse, the fabric aesthetic characteristics and it also required very large throughput to become a competitively viable process. The development of the non-contact ink-jet printing process is changing the whole concept of how printed fabrics can be viewed and for the automotive producer solve many of the previous problems. A study of the process and the advantages it offers are contained in Section 4.3. At least one producer world-wide is making great progress in developing this specifically for automotive applications. All those involved in the business of producing interior trim fabrics should be looking very hard at this as a vision of the future and an opportunity which needs exploiting and refining to better service the OEMs.

## 10.7 Further visions of the future

Production costs are likely to be driven down even further not only by commercial and technological innovation but also by advancements in communications via the Internet. There is already some purchasing activity using this facility, but the major OEMs are to develop integrated on-line purchasing networks which will create a virtual marketplace for parts, goods and services. Expected purchasing cost savings to the OEM are believed to be up to 20% and suppliers using similar systems could also cut their procurement costs by the same amount.<sup>15</sup>

The car of the future will contain large amounts of composites, possibly carbon fibres, have no heavy glass in it and will be virtually non-polluting. It could be driven by electricity, fuel cell, cleaner petrol or some other fuel, or a combination of these technologies – a ‘hybrid’. Electric vehicles may increase the amount of fabric needed for battery separators. A smoother, quieter vehicle is likely to require less vibration- and noise-control material, which could harm the polyurethane industry but could also affect textiles. In the USA, the federal government and the main auto-makers, have formed a Partnership for a New Generation of Vehicles (PNGV). The objective is to redesign the car so it will be three times more economical than the present average medium size car but at the same time have the same performance, same safety features and same ownership costs.<sup>16</sup> The new generation vehicle will be easier to recycle and will weigh substantially less than present cars. This will be made possible by an integrated approach to the redesign of the vehicle, by making use of

polymer composites. In the UK there is similar activity via the Foresight Vehicle Programme.

The trend of fewer suppliers will continue and indeed there is likely to be significantly fewer OEMs. Some analysts predict that only six major producers will be operating in the year 2020 compared to the present 20. There could be as few Tier-1 (or 'Tier-0.5') suppliers, and some analysts believe Tier-2 suppliers may disappear altogether – having been bought up by the Tier-1s! Analysts warn however, that this general loss of contact between the OEMs and the smaller companies may be detrimental to innovation.

Production runs will be very large, but at the same time there will be greater choice for the buying public, partly by the use of fewer platforms and even OEMs sharing each others' platforms. There will also be a greater choice of interior trim, maybe by the increased use of printing on to standard base fabrics or by the use of computer-controlled knitting – perhaps involving 3-D knitting. The possibility of customers communicating their own designs via the Internet has already been mentioned.

The plastic manufacturers have joined forces to produce an alternative for glass, which will reduce further the weight of cars. Glass replacement with polycarbonate plastic is likely to alter the spectral distribution of sunlight entering the car and if this is significant it could well modify fibre and material type and dye and pigment choice for the car interior. In addition it may be possible with the use of additives to the polycarbonate to filter out more of the damaging UV rays which would further extend design possibilities. Car interiors are likely to become cooler in any case – at least while occupied – by the widespread use of air-conditioning, which could open further opportunities for the use of different kinds of fabric.

All cars in the not too distant future are likely to have items such as air conditioning, refrigerators and satellite navigation systems fitted as standard. Textile development must keep pace with these levels of luxury and in general match advancements in the quality of life provided by other sectors of industry. It may be possible to automatically provide ideal seat thermal comfort by controlling conditions within the human skin-car seat cover micro-climate as well as providing other aspects of comfort within the car.<sup>17</sup> Already heating can be provided by a textile fibre which is capable of evenly distributing warmth throughout the car.<sup>18</sup>

There are more scientists and technologists alive and working than any other time in the history of the world and they have the benefit of the latest computers and equipment. They can converse with fellow researchers all over the world instantly via the telephone, the fax machine and e-mail. They have access to a wealth of information in all the libraries, databases and via the Internet. As one writer put it 'technology is never going to be as slow as it is today'.

## 10.8 References

1. Kazmin AL & Tait N, 'US carmakers take lessons from Indian Consumer', *Financial Times* 22 November 1999, 9.
2. Yamada Y, 'Holding the odours', *Automotive Interiors International*, Winter 1992/3, 52–8.
3. Hearle JWS, 'Genetic engineering and fibre production and properties', *Index '99*, R & D session 1, 27–30 April 1999, Brussels, EDANA.
4. Anreja (DuPont), 'New fibre for the Millennium', *World Textile Congress, Industrial, Technical and High Performance Textiles*, Huddersfield 15–16 July 1998, Huddersfield University.
5. Scolari P, 'Towards a sustainable mobility at the turn of the century; the environmental challenge', *ATA Ingegneria Automotoristica*, November/December 1997, 50, 11/12, 586–95.
6. Anon, 'News Opinion', *FT Automotive Manufacturing*, Issue 1, May 1998.
7. DETR literature, 'Driving the Agenda – The First Report of the Cleaner Vehicles Task Force', July 1999, 25.
8. Adrian C (Aerotek, CSIR), 'Optimised rim reinforcements', *TuT*, 2nd Trimestre, (20), 1996, 55–6.
9. Kurylko DT, 'Death Tax', *Automotive News International*, September 1999, 20–1.
10. Kurylko DT, 'Carmakers criticize 10 billion Euro scrappage ruling', *Automotive News Europe*, February 14 2000, 18/20.
11. Pryweller J, 'Ford sets tough new guidelines for recycled plastics', *Automotive News Europe*, 5 July 1999, 22.
12. Anon, 'Vehicle recycle standard set out', *PRW*, 25 February 2000, 1.
13. Boswell B, 'Design for disassembly; seating solutions competition', *Automotive & Transportation Interiors*, September 1999, 9.
14. Riedel V, Nickel J & Hermann S, 'Biocomposites for needlefelt nonwovens', *Index '99* Geneva, 27–30 April 1999, Brussels, EDANA.
15. Couretas J, 'Ford and GM Internet deals are "wake-up" call to auto industry', *Automotive News Europe*, 8 November 1999, 1.
16. Wilkes CE, Rudd CD, Long AC & Johnson CF, 'Textile reinforcements for automobile composites', *World Textile Congress*, Huddersfield, 15–16 July 1998. (From 'Partnership for a New Generation of Vehicles', US Dept of Commerce, Washington, 1997)
17. (Several authors), 'Future vision: interiors for the millennium', *Automotive & Transportation Interiors*, December 1999, 22–30.
18. Creasy L, 'Innovations', *Automotive & Transportation Interiors*, July 1998, pp 12–13.

## 10.9 Further reading

1. Aneja AP (DuPont), 'New fibres for the Millennium', *World Textile Congress, Industrial, Technical & High Performance Textiles*, Huddersfield, 15–16 July 1998, Huddersfield University 1998.
2. DETR (UK Government) literature, 'Driving the Agenda – the First Report of the Cleaner Vehicles Task Force', London, July 1999.
3. DETR (UK Government) literature, 'Environmental Impacts of Road Vehicles in Use', London, July 1999.

4. Elkington J & Hailes J, '*Manual 2000*', London, Hodder & Stoughton, 1998, 164–210.
5. Hearle JWS, 'Genetic engineering and fibre production and properties', *Index '99*, Geneva, 27–30 April 1999, Brussels, EDANA.
6. Hiratsuka S (Teijin), 'Present situation and future outlook for technological developments in man-made fibres', *JTN*, July 1996, 56–76.
7. Horrocks AR (ed.), '*Ecotextile '98 – Sustainable Development*' Proceedings of Conference, 7–9 April 1998 at Bolton, Abington, Cambridge, Woodhead, 1999.
8. JTN Special Edition 'Japanese state of the art textiles 2000'. *JTN*, January 2000.
9. Paasila M (Rieter), 'Trends in the global automotive industry', *TTi* December 1998 5–7.
10. '*The Future of Travel*' – Government White Paper, HMSO, 1998.
11. Time Special Issue, '*Our Precious Planet*', November 1997.
12. '*The World in 2000*', (Annual forecast), London, The Economist Group.
13. *World Textile Congress, 'Industrial, Technical & High Performance Textiles'*, 15–16 July 1998, Conference Papers, Huddersfield University 1998.

The automotive and textile industries are constantly changing and new information is constantly being produced. Keeping up to date is time consuming but need not be difficult providing research and development staff and others know where to look, which relevant journals to read and which conferences and exhibitions to attend. This section enumerates some sources of information likely to be of use to the automotive textile engineer. Attending conferences and exhibitions is an excellent way of keeping up to date and making personal contacts, but the more specialist ones may seem to be not well publicized to those not already involved in the industry.

Publications of the Textile Institute and World Textile Publications Ltd. are invaluable in keeping up to date in both academic and more industrial aspects. So far as wet processing is concerned the *Journal of The Society of Dyers and Colourists* and its annual *Review of Progress in Coloration* are excellent sources of information with extensive references. The monthly *International Dyer* features topical news and views and well-presented articles of a more practical nature. World Textile Publications also produce invaluable directories such as '*Index to Textile Auxiliaries*', and directories of UK textile agents and dyers and finishers in the UK and abroad.

Automotive textiles are closely linked to plastics, and journals of the plastics industry regularly feature news and information invaluable to the automotive textile technologist. Automotive textiles are used together with plastics in processes originally designed for plastics such as moulding and, indeed, polyester, nylon and polypropylene are used in the car in both plastic and fibre forms. *Plastics and Rubber Weekly* reports the latest news and developments in its area of interest and regularly features items and specialist articles in the automotive sector. *British Plastics and Rubber*, *European Plastics News* and the American publication *Modern Plastics International* all regularly feature news items and technical papers on the auto industry. The Institute of Materials, which now incorporates the Plastics and Rubber Institute, is a professional body, which keeps its

members informed of the latest developments through publications and conferences.

A growing number of journals specific to automotive interiors have appeared within the last 6 years or so and this underlines the growing importance of this part of the car. But it is important to be aware of the automotive industry as a whole, which is one of the most 'global' of industries in every aspect. This can be done by regularly studying some of the many automobile publications. In addition many national newspapers include motoring features, especially at weekends, which provide valuable consumer views and opinion on automotive products.

In addition to the conferences and symposia listed below, many additional ones are organized regularly by the Textile Institute, the Society of Dyers and Colourists and the Institute of Materials. Local and regional branches of these bodies meet regularly. Universities and research organizations such as the British Textile Technology Textile Group (BTTG) and RAPRA Technology also organize conferences and run short courses on various subjects. The Center for Professional Advancement regularly run courses on technical subjects including polymer compounding, plastics additives, coating processes both in the USA and in Europe. The Industrial Fabrics Association International (IFAI) whose activities are at present mainly in the USA, has a growing number of members in Europe and Japan and eventually regular meetings of branches in these areas will be held. The IFAI have specialist divisions, the relevant ones are, Marine Fabricators Association, Awning Division, Truck Cover and Tarpaulins Association and the Transportation Division. Composites Symposia are organized by universities and by various professional bodies including the Institution of Mechanical Engineers. Nottingham University has a 'Composites Club'. Technomic Publishing, the publishers of the Journal of Coated Fabrics, organize short courses and symposia on textile and polymer science subjects including an annual symposium on coated fabrics at various locations in Europe.

## 11.1 Conferences

### 11.1.1 General textiles

- 1 'International Man Made Fibres Congress', held annually at Dornbirn, Austria. In recent years automotive textiles have been featured every 2 years. Organized by Osterreichisches Chemiefaser-Institut Tagungsburo Dornbirn, Rathausplatz 1, A-6850 Dornbirn, or Kolingasse 1, A-1090 Vienna, Austria. The conference is sponsored and arranged in association with the CIRFS, Avenue E Van Nieuwenhuyse 4, B-1160 Brussels and the City of Dornbirn.

- 2 'Techtextil', held annually in Frankfurt, Germany where about a hundred papers on all aspects of technical textiles are presented. Organized by Messe Frankfurt GmbH, Postfach 15 02 10, D-60062, Frankfurt am Main, Germany.
- 3 'Textiles in Automobiles' (sometimes run in conjunction with the Plastics in Automobile Engineering Conference). Held on average every 2 to 3 years. Organized by Verein Deutscher Ingenieure (VDI), Graf-Recke-Strasse 84, D-40239 Dusseldorf, Germany.
- 4 'World Textile Congress', Huddersfield, England held annually featuring different aspects. Department of Textiles, University of Huddersfield, Queensgate, Huddersfield HD1 3DH, UK.
- 5 'Fibre to Finished Fabrics', organized annually by the Textile Institute usually in December in Manchester.

### 11.1.2 Automotive conferences

These regular conferences feature automotives and automotive interiors in general and are not specific to textiles. There are many others organized covering every aspect of technology and environmental issues. In the USA, the IFAI periodically organizes conferences on automotive interior trim and fabric.

- 1 Automotive and Transportation Interiors Expo, organized in the USA by the magazine of the same name.
- 2 Autoplas conferences on use of plastics in the automobile, (and also Recycling) organized by Schotland Business Research Inc., 16 Duncan Lane, Skillman, New Jersey 08558-2313, USA.
- 3 'Autotech Conference', held annually at the National Exhibition Centre, Birmingham organized by Centre Exhibitions jointly with the Institute of Mechanical Engineers, Automobile Division. NEC House, Birmingham B40 1NT, UK.
- 4 'Comfort in the Automotive Industry', organized approximately every 2 years by the Italian Associazione Technica Dell'Automobile (ATA) and Bologna University and held at Bologna. ATA, Strada Torino, 32/A, 10043 Orbassano (TO), Italy.
- 5 'Inter Auto' is organized by Inside Automotives International in conjunction with the Turret group. The last two events in Europe have been held at the RAI Centre, Amsterdam. Inside Automotives International, ANCAR Publications Inc., 21700 Northwestern Highway, Suite 565, Southfield, Michigan 48075 USA.
- 6 ISATA, (International Symposium on Automotive Technology and Automation) an annual event, organized by Dusseldorfer Messegesellschaft mbH-NOWEA, Postfach 101006, D40001, Dusseldorf, Germany.

### 11.1.3 Other relevant conferences

- 1 'Intabond', conference on hot-melt adhesive technology organized every 2 to 3 years by Dermil Research Ltd., 24 Buckingham Square, Wickford Business Park, Wickford, Essex SS11 8YQ, UK.
- 2 'Interplas' and 'Kunststoff' are international chemical exhibitions – organized every 2 to 3 years in Birmingham (NEC) and Dusseldorf. Dusseldorfer Messgesellschaft mbH-NOWEA, D-4000 Dusseldorf, Germany.
- 3 'Rubber Bonding' and other conferences are organized periodically by RAPRA Technology Ltd., in conjunction with partners such as *European Rubber Journal*.
- 4 Textile Coating and Lamination International Conferences organized annually by the *Journal of Coated Fabrics* – Technomic Publications Inc., 851 New Holland Avenue, Box 3535, Lancaster, PA 17604, USA.
- 5 'Urethanes Technology' organized by Crains Communications Ltd – both in Europe and Asia.

### 11.1.4 Machinery and materials

- 1 'Expofil'-European yarn Exhibition, held twice annually, Rue de Neuilly, BP 121, F92113 Clichy Cedex, Paris, France.
- 2 'Index' conference, (for non-woven fabrics), organized in Europe, usually in Geneva by EDANA-see above.
- 3 Conferences and exhibitions organized by the Messe Frankfurt, Messe Frankfurt GmbH, Postfach 15 02 10, D-60062 Frankfurt am Main, Germany, are held in Europe but recently additional events have been held in other parts of the world including Asia and South America. These include: (3.1) 'Interstoff'-yarns for fashion and performance, (Ludwig Erhard Anlage 1, 60327 Frankfurt-am-Main; (3.2) 'InterYarn'; and (3.3) 'Heimatex' (household and hospitality textiles).
- 4 'ITMA', the International Textile Machinery Exhibition is held usually every 3 years; the location rotates between Milan, Paris and Hanover. It is by far the largest exhibition of its type. Organized by the CEMATEX-Comité Européen des Constructeurs de Matériel Textile, General Secretary, Bredewater 20, Postbus 1 90, NL-2700 AD Zoetermeer, Netherlands.

## 11.2 Journals

Many of the journals publish an annual resource file, where to buy guide, year book or review of progress.

## 11.2.1 Textile journals

- 1 *ATI, (America's Textiles International)*, Billian Publishing Inc., 2100 Powers Ferry Road, Atlanta, Georgia 30339 USA.
- 2 *International Fiber Journal* published six times a year by International Media Group Inc., 1515 Mockingbird Lane, Suite 210, Charlotte, North Carolina 28209 USA.
- 3 *International Textile Bulletin, Textile Leader* published four times a year by International Textile Services, Univer Hans, Kessler Strasse 9, CH-8952, Schlieren, Zurich, Switzerland.
- 4 *Japanese Textile News, Monthly*, (Japanese Textile News) Osaka Senken Ltd., 3-4-9, Bingomachi, Chuo-ku, Osaka 541-0051, Japan.
- 5 *Kettenwirk-Praxis* (German, with English translations) published four times a year by Karl Meyer Textilmaschinenfabrik GmbH, Postbox 1120, D-63166, Obertshausen, Germany.
- 6 *Knitting International* published by World Textile Publications – see Textiles Horizons, (9) below.
- 7 *Nonwovens Report International*, published by World Textile Publications Ltd., see Textile Horizons, (9) below.
- 8 *Textile Asia* published by Business Press Ltd, California Tower 11th Floor, 30–2 D'Aguilar Street, Hong Kong.
- 9 *Textile Horizons* published by The Textile Institute and World Textile Publications Ltd., Perkin House, 1 Longlands Street, Bradford, West Yorkshire BD1 2TP, UK.
- 10 *Textile Monthly* published by World Textile Publications – see Textile Horizons, (9) above.
- 11 *Textiles World* published by Maclean Hunter Publishing Co., 29N Wacker Drive, Chicago, Illinois 60606 USA.

## 11.2.2 Technical textiles

- 1 *Chemical Fibers International* issued six times a year with annual Year Book, IBP International Business Publishers GmbH, Mainzer Landstrasse 251, D-60326 Frankfurt am Main, Germany.
- 2 *High Performance Textiles*, monthly newsletter from International Newsletters – see Technical Textiles International, (7) below.
- 3 *Industrial Textiles* published by Impact! on behalf of the Made-up Textiles Association (MUTA), Media House, 55 Old Road, Leighton Buzzard, Bedfordshire LU7 7RB, UK.
- 4 *International Textile Bulletin, Yarn and Fabric Forming*, published four times a year by International Textile Service, see (3) in Section 11.2.1 above.

- 5 *Journal of Coated Fabrics*, Technomic Publishing Company Inc., 851 New Holland Avenue, Box 3535, Lancaster, Pennsylvania 17604 USA and in Europe Missionsstrasse 44, CH-4055 Basel, Switzerland.
- 6 *Melliand Textilberichte*, (also Melliand English), 60264, Frankfurt am Main, Germany.
- 7 *Technical Textiles International*, (with annual where to buy guide), International Newsletters, P O Box 133, Witney, Oxford OX8 6ZH, UK.
- 8 *Technische Textilien*, (German with English Translations), PO Box 10 0606, D-6000 Frankfurt am Main, Germany.
- 9 *Textiles Usage Textiles* (TUT), (French with English summaries) published by Euredia SA-editorial collaboration with the French Textile Institute, 16 Rue Ballu F-75311, Paris cedex 09, France.

### 11.2.3 Dyeing and finishing

- 1 *American Dyestuff Reporter*. Promenade A, Suite 2, Harmon Cove Towers, Secaucus, NJ 07094, USA.
- 2 *International Dyer* published by World Textile Publications Ltd., see Textile Horizons, (9) in Section 11.2.1.
- 3 *International Textile Bulletin, Dyeing, Finishing, Printing*, published four times a year by International Textile Service, see (3) in Section 11.2.1.
- 4 *Journal of the Society of Dyers and Colourists*, (with annual Review of Progress in Colouration and annual Resource File), published ten times a year by the Society of Dyers and Colourists.
- 5 *Textile Chemist and Colorist* published by the American Association of Textile Chemists and Colorists, PO Box 12215, Research Triangle Park, North Carolina 27709, USA.

### 11.2.4 Plastics and chemicals

- 1 *British Plastics and Rubber*, MCM Publishing Ltd., 37 Nelson Road, Caterham, Surrey, CR3 5PP, UK.
- 2 *European Plastics News*, EMAP Maclaren, Maclaren House, 19 Scarbrook Road, Croydon, Surrey CR9 1QH, UK.
- 3 *European Adhesives and Sealants* (with annual Year Book), FMJ International Publications, Queensway House, 2 Queensway, Redhill, Surrey RH1 1QS, UK.
- 4 *Modern Plastics International* (with annual buyers guide), McGraw Hill, Modern Plastics International, P O Box 605, Hightstown NJ 08520 USA.
- 5 *Plastics and Rubber Weekly*, EMAP Business Communications, Ruislip, Middlesex HA4 9LT, UK.

- 6 *Urethanes Technology*, Crain Communications Ltd., New Garden House, 78 Hatton Garden, London EC1N 8JQ, UK.

### 11.2.5 Composites

- 1 *Advanced Composites Bulletin*, monthly from International Newsletters – see Technical Textiles International, (7) in Section 11.2.2.
- 2 *Composite Science and Technology*, published 16 times a year by Elsevier Science Ltd., The Boulevard, Langford Lane, Kidlington, Oxford OX5 1GB, UK.
- 3 *Material Science* published by the Institute of Materials, 1 Carlton House Terrace, London SW1Y 5 DB, UK.

### 11.2.6 The environment

- 1 *Environment Business Magazine*, (annual Directory) Information for Industry Ltd., 4 Valentine Place, London SE1 8YX, UK.
- 2 *Environment Times* (quarterly), Beckhouse Media, 22 Warwick Street, Adlington, Lancashire PR7 4JQ, UK.
- 3 *The ENDS Report*, Environmental Data Services Ltd., Finsbury Business Centre, 40 Bowling Green Lane, London EC1R 0NE, UK.
- 4 *European Environment* published six times a year by John Wiley and Sons, Baffins Lane, Chichester, West Sussex, PO19 1UD, UK.
- 5 *EUWID Recycling and Waste Management*, PO Box 1332, D-76586 Gernsbach, Germany.
- 6 *Material Recycling Weekly*, EMAP Maclaren Ltd., 19 Scarbrook Road, Croydon CR9 1QH, UK.

The Environment Agency, Rio House, Waterside Drive, Aztec West, Almondsbury, Bristol BS32 4UD. The Department of the Environment publish a large amount of free literature on environmental matters, energy conservation and other issues. Free advice is offered as well as information on technical matters, environmental legislation, conferences and seminars. They have a telephone helpline 0800 585794 (in the UK) and have a web site <http://www.etsu.com/etbpp/>

The European Union also produce information on the environment – the general contact is Office for official publications of the European Communities, L-2985 Luxembourg.

The National Society for Clean Air and Environment Protection (NSCA), 136 North Street, Brighton BN1 1RG. NSCA issue their Pollution Handbook every 2 or 3 years and also publish a series of well-written and well-presented information leaflets for the general public.

### 11.2.7 Automotive interiors

- 1 *Automotives Interiors International*, Turret-RAI plc., Armstrong House, 38 Market Square, Uxbridge, Middlesex, UB8 1TG, UK.
- 2 *Automotive & Transportation Interiors*, (with annual where to buy guide), 6255 Barfield Road, Suite 200, Atlanta, Georgia 30328-4300 USA.
- 3 *Inside Automotives International*, (with annual where to buy guide), ANCAR Publications Inc., 21700 Northwestern Highway, Suite 565, Southfield, Michigan 48075 USA.

### 11.2.8 Automotives – general

- 1 *Automotive Engineering* (a publication associated with SAE of the USA), PO Box 5004, Pittsfield MA 01203-9990, USA.
- 2 *Automotive News Europe*, Crain Communications Intl., New Garden House, 78 Hatton Garden, London EC1N 8LD, UK.
- 3 *Automotive Industries AI*, 201 King of Prussia Road, Radnor, PA., or 3011 W. Grand Boulevard, Ste. 2600 Detroit, MI 48202, USA.
- 4 *Automotive News International* (as Automotive News Europe above).
- 5 *Automotive Sourcing*, bimonthly, 6 Heathgate Place, 75–87 Agincourt Road, London NW3 2NT, UK.
- 6 *Automotive World Publications*, (Financial Times), Maple House, 149 Tottenham Court Road, London W1P 9LL, UK.
- 7 *Car* published by EMAP National Publications Ltd, Angel House, 338–46 Goswell Road, London EC1V 7QP, UK.
- 8 *Vehicle News*, (*L'information du vehicule*), published by Interpress, 36 Rue Ballu F-75009 Paris, France.

## 11.3 Technical and professional organizations and institutions

### 11.3.1 Textile

- 1 American Association of Textile Chemists and Colorists, P O Box 12215, Research Triangle Park, North Carolina 27709-2215 USA.
- 2 American Flock Association c/o NTA Bolgen, 230 Congress Street, Boston MA 02110 USA.
- 3 American Textile Manufacturers Institute, 1130 Connecticut Avenue, NW-Suite 1200, Washington DC 20036-3954, USA.
- 4 Association of Nonwovens Fabric Industry, PO Box 1288 Cary, North Carolina 27512, USA.
- 5 BTTG, (British Textile Technology Group), Shirley House, Wilmslow Road, Didsbury, Manchester M20 2RB, UK.

- 6 CIRFS (Comité International de la Rayon et des Fibres Synthétiques), Avenue E Van Nieuwenhuysse 4, B-1160 Brussels, Belgium.
- 7 Deutsches Wollforschungsinstitut (DWI), Veltmanplatz 8, D-52062 Aachen, Germany. (German Wool Institute – Organizers of the annual Aachen Textile Conference.)
- 8 EDANA, (The European Disposables and Nonwoven Association), 157 Avenue Eugene Plasky, Bte 4-1030 Brussels, Belgium.
- 9 Ghent University, Dept of Textiles, Technologiepark 9, 9052 Gent Zwijnaarde, Belgium.
- 10 Hohenstein Institutes, Schloss Hohenstein, D-74357 Boennigheim, Germany.
- 11 Industrial Nonwovens and Disposable Association, 1700 Broadway 25<sup>th</sup> Floor, New York, NY 10019 USA.
- 12 Institut Textile de France, Avenue Guy de Collongue-B.P. 60-69123 Ecully Cedex, France.
- 13 International Industrial Fabrics Association (IFAI), Several divisions including a Transportation Division and European and Japanese Branches. IFAI USA, 1801 County Road B W, Roseville, MN 55113-4061 USA. European Office; IFAI Europe, Marcel Thiryiaan 204, B-1200 Brussels, Belgium. Japanese Office, IFAI Japan, 3-8-9 Nishidai, Itami, Hyogo 664, Japan.
- 14 Made-Up-Textiles Association Ltd. (MUTA), 42 Heath St. Tamworth, Staffordshire, B79 7J, UK.
- 15 North Carolina State University, Dept of Textiles, Box 8301, Raleigh, North Carolina 27695-8301, USA.
- 16 Osterreichisches Chemiefaser, Kollingasse 1, A-1090 Vienna, Austria.
- 17 Society of Dyers and Colourists, (publishes monthly Journal and annual resource file), P O Box 244, Perkin House, 82 Gratton Road, Bradford, West Yorkshire BD1 2JB, UK.
- 18 Sachsisches Textil Forschungs Institut, Annaberger Strasse 240, D-09125, Chemnitz, Germany.
- 19 Swedish Institute for Fibre & Polymer Research (IFP), Box 104, SE-431 22 Molndal, Sweden.
- 20 The Textile Institute, St James's Buildings, Fourth Floor, Oxford Street, Manchester M1 6EJ, UK.
- 21 The Textile Technical Institute (AKZO Nobel), Kasinostrasse 19–21, D-42103 Wuppertal, Germany.
- 22 The Nonwovens Network, BTTG WIRA House, West Park Ring Road, Leeds LS16 6QL, UK.
- 23 Verband de Flockindustrie eV, (Association of the Flock Industry), Tannenberger Strasse 66/62 D-72760 Reuttingen, Germany.
- 24 WIRA Technology (BTTG), West Park Ring Road, Leeds LS16 6QL, UK.

- 25 Woolmark Company, Valley Drive, Ilkley, West Yorkshire LS29 8PB, UK.
- 26 Wools of New Zealand, Design and Development, Little Lane, Ilkley, West Yorkshire, LS29 8UG, UK.

### 11.3.2 Some UK universities/institutions with textile departments

- 1 Bolton Institute, Deane Road, Bolton BL3 5AB, UK.
- 2 Huddersfield University, Queensgate, Huddersfield HD1 3DH, UK.
- 3 Leeds University, Leeds LS2 9JT, UK.
- 4 Manchester Metropolitan University, Cavendish Building, Manchester M1 5GD, UK.
- 5 Nottingham Trent University, Burton Street, Nottingham NG1 4BU, UK.
- 6 Royal College of Art (Postgraduate Art & Design – Textile Design), Kensington Gore, London SW7 2EU, UK.
- 7 Heriot-Watt University, Scottish Borders Campus (formerly Scottish College of Textiles), Netherdale, Galashiels, Selkirkshire TD1 3HF, UK.
- 8 UMIST, PO Box 88, Manchester M60 1QD, UK.

### 11.3.3 Plastics, rubber and composites

- 1 Association of Plastics Manufacturers in Europe (APME), Avenue E. Van Nieuwenhuysse 4, Box 3, B-1160 Brussels, Belgium.
- 2 British Rubber Manufacturers' Association Ltd., 90 Tottenham Court Road, London W1P 0BR, UK.
- 3 The Society of Advanced Materials and Process Engineers (SAMPE), International Business Office, 1161 Parkview Drive, Covina, California 91724-3748 USA.
- 4 The British Plastics Federation, 6 Bath Place, Rivington Street London EC2A 3JE, UK.
- 5 The Center for Professional Advancement, Box 1052, 144 Tices Lane, East Brunswick, NJ, USA 08816-1052.
- 6 Institute of Materials, 1 Carlton House Terrace, London SW1Y 5DB, UK.
- 7 Nottingham University Composites Club, School of Mechanical Materials, Manufacturing Engineering and Management, University of Nottingham, University Park, Nottingham NG7 2RD, UK.
- 8 RAPRA Technology Ltd., (Rubber Industries Research Association), Shawbury, Shrewsbury, Shropshire, SY4 4NR, UK.
- 9 The Society of Plastics Engineers, 14 Fairfield Drive, PO Box 403, Brookfield, CT 06804-0403 USA.

- 10 The Malaysian Rubber Producers' Research Association, Tun Abdul Razak Laboratory, Brickendonbury, Hertford SG13 8NL, UK.
- 11 VDI-Gesellschaft Kunststofftechnik (VDI-K), Graf-Recke-Strass 84, 40239 Dusseldorf, Germany. (Institute of German Engineers – Technical Plastics).

### 11.3.4 General engineering/joining technology

- 1 Alliance of Automobile Manufacturers (AAM) 1401 H Street NW-Suite 900, Washington DC 20005-2110, USA.
- 2 Japanese Automobile Manufacturers Association (JAMA), Otemachi Bldg., 6-1, Otemachi 1-Chome, Chiyoda-ku, Tokyo 100-0004, Japan. European address; 327 Avenue Louise, B 1050 Brussels, Belgium.
- 3 Loughborough University, Institute of Surface Science and Technology, Ashby Road, Loughborough, Leics LE11 3TU, UK.
- 4 Oxford Brookes University, Joining Technology Research Centre, Oxford OX3 0BP, UK.
- 5 Society of Automobile Engineers (SAE), 400 Commonwealth Drive, Warrendale PA 15096-001 USA.
- 6 Society of Motor Manufacturers and Traders (SMMT), Forbes House, Halkin Street, London SW1X 7DS, UK.
- 7 Organisation Internationale des Constructeurs d'Automobiles (OICA-International Organisation of Motor Vehicle Manufacturers), 4 Rue de Berri F-75008 Paris, France.
- 8 The Institute of Mechanical Engineers – Automobile Division (IMechE), 1 Birdcage Walk, London SW1H 9JJ, UK.
- 9 The International Federation of Automotive Engineering Societies (FISITA), 1 Birdcage Walk, London SW1H 9JJ, UK.
- 10 Verband Der Automobilindustrie eV (VDA), Westendstrasse 61, Postfach 17 05 63, D-60325 Frankfurt am Main 17, Germany.
- 11 The Welding Institute (TWI), Abington Hall, Abington, Cambridge CB1 6AL, UK. N.B. 'Welding' encompasses all joining techniques – including adhesives.

### 11.3.5 Testing and standards

- 1 American Association of Textile Chemists and Colorists, PO Box 12215, Research Triangle Park, North Carolina 27709-2215, USA.
- 2 American Standards Institute (ANSI), 11 West 42<sup>nd</sup> Street, 13 Floor, New York, NY 10036-8002, USA.
- 3 Association Française de Normalisation, F-92049 Paris, La Defense Cedex, France.

- 4 ASTM (American Society for Testing and Materials), 1916 Race Street, Philadelphia PA 19103-1187, USA.
- 5 British Standards Institution, 389 Chiswick High Road, London W4 4AL, UK.
- 6 CEN (The European Committee For Standardization), Central Secretariat; Rue de Stassart 36, B-1050 Brussels.
- 7 Detroit Testing Laboratory Inc., 7111 E Eleven Mile, Warren MI 48092, USA.
- 8 DIN Deutsches Institut fur Normung, Burggrafenstrasse 6, D-10787 Berlin, Germany.
- 9 Ente Nazionale Italiano di Unificazione, Via Battistotti Sassi 11/b 1-20133 Milano, Italy.
- 10 International Organization for Standardization, Central Secretariat, 1 Rue de la Varenbe Caisse Postale 56, CH-1211, Geneva 20, Switzerland.
- 11 Korean National Institute of Technology and Quality, 1599 Kwanyang-dong, Dongan-ku, Anyang City Kyonggi-Do 430-060, Republic of Korea.
- 12 Japanese Industrial Standards Committee, Department of Standards, Industrial Science and Technology Agency, Ministry of International Trade and Industry, 1-3-1, Kasumigaseki, Chiyoda-ku Tokyo 100.
- 13 United States Testing Inc., 1415 Park Ave., Hoboken NJ 07030, USA.

#### **11.4 Market information on automotive industry**

- 1 Inside Brief, Turret RAI PLC, Armstrong House, 38 Market Square, Uxbridge, Middlesex UB8 1TG, UK.
- 2 IFAI, 1801 County Road, BW Roseville MN 55113-4061, USA. (Members)
- 3 Intercontuft (International Consultants), 3080 Tervuren, Moorelboslaan 15, Belgium.
- 4 Financial Times Automotive, Maple House, 149 Tottenham Court Road, London W1P 9LL, UK.
- 5 LMC Automotive Services, 14-16 George Street, Oxford OX1 2RF and in the USA; LMC Automotive Services. 1841 Broadway, Suite 611, New York, NY 10023, USA.
- 6 Marvel, 11 Place du General Leclerc, F-92300 Levallois-Perret, France.
- 7 Motor Industry Research Association, (MIRA), Watling Street, Nuneaton, Warwickshire CV10 0TU, UK.
- 8 Ward's Automotive International, published twice monthly, Ward's Communications, 3000 Town Center, Suite 2750, Southfield, Michigan 48075 USA.

## 11.5 General textile reference

- 1 'European Index of Yarns and Fibres', 3rd edn, Bradford, World Textile Publications 1999.
- 2 'Index to Textile Auxiliaries', 17th edn, Bradford, World Textile Publications 2000.
- 3 McIntyre JE & Daniels PN (eds), 'Textile Terms & Definitions', 10th edn, Manchester, The Textile Institute, 1995.

## 11.6 Glossary of terms and abbreviations

These are for information only by the reader in the context of textiles in transportation; they should not be considered as official definitions. There is a growing number of abbreviations being used in the automotive industry to describe processes, materials, and even type of vehicle. These are in addition to the chemical, engineering, and information technology terms. Many of these abbreviations are presented in the list here, which is by no means intended to be exhaustive. The automobile textile engineer will come across all these in the course of his or her duties. There is a 'Textile Terms and Definitions' publication available from the Textile Institute.

AAMA	American Automobile Manufacturers Association.
AATCC	Association of American Textile Chemists and Colourists.
ABC pillars	structures which support the roof in a car. A at the front holding the windscreen, B at the centre and C at the rear.
ABS	acrylonitrile-butadiene-styrene plastic. Not to be confused with automatic braking system.
ACEA	European Automobile Manufacturers Association.
ACORD	Automotive Consortium on Recycling and Disposal.
AIAG	Automotive Industry Action Group (USA).
ALREM	Association of Load Restraint Equipment Manufacturers.
APME	Association of Plastics Manufacturers in Europe.
ASTM	American Society for Testing and Materials.
ATA	Associazione Tecnica dell'Automobile (Italy).
ATH	aluminium trihydrate (flame retardant agent).
BATNEEC	best available techniques not entailing excessive cost (for prevention of release of harmful substances to the environment).
BCF	bulked continuous filament.

Benchmarking	a procedure which compares competitive products to one's own and then seeks to establish the 'best practice'.
BOD	biological oxygen demand.
BPF	British Plastics Federation.
BRITE EURAM	Basic Research for Industrial Technologies in Europe, European Research in Advanced materials (EU sponsored research).
BSI	British Standards Institution, hence BS = British Standard.
BS AU	British Standard Automobile Series.
BTTG	British Textile Technology Group.
CAD	computer assisted design.
CAM	computer assisted manufacturing.
CARE	Consortium for Automotive Recycling.
CEFIC	European Chemical Industry Council (Federation).
CEN	Comite European de Normalisation.
CFC	chlorofluorocarbons, chemicals once used in refrigeration, foam making etc. Identified as damaging to the environment and now being phased out world-wide.
CHIP	chemical hazard information & packaging regulations.
CIELAB	Commission International du Eclairage (LAB refers to colour differences calculated).
CIRFS	Comité International de la Rayonne et des Fibres Synthétiques (Brussels).
COD	chemical oxygen demand, the amount of oxygen needed to purify effluent.
COSHH	Control of Substances Hazardous to Health.
CRAG	Composite Research Advisory Group, (UK Ministry of Defence).
CRE	constant rate of extension.
CRL	constant rate of load.
CTR	constant rate of traverse.
DBDO	decabromo diphenyl oxide (flame retardant agent).
DETR	Department of the Environment, Transport and the Regions. (UK).
DFD	design for disassembly.
DFM	design for manufacture.
DIN	Deutsches Institut für Normung (German Standards Institute).
Dioxins	a generic term applied to groups of chemicals including polychlorinated dibenzo- <i>p</i> -dioxins (PCDDs) and chlorinated dibenzo-furans. They are sometimes pro-

	duced as by-products in certain combustion processes and some are extremely toxic.
DOE	Department of the Environment.
DTCA	Defence Clothing and Textile Agency (UK).
ECE	European Colourfastness Establishment.
EDANA	European Disposables and Nonwovens Association.
ELV	end-of-life vehicle. Vehicle that has come to the end of its useful life – sometimes referred to as EOL – end-of-life vehicle.
EMAS	European Eco-Management and Audit Scheme.
EMS	Environmental Management System.
Energy recovery	the useful energy produced by using waste material as fuel.
EOL	end-of-life vehicle.
EPM	ethylene propylene monomer rubber.
EPDM	ethylene propylene diene monomer rubber.
EV	electric vehicle.
EVA(c)	ethylene vinyl acetate.
FAAS	flame atomic absorption spectroscopy.
FAKRA	Fachnormenausschuss Kraftfahrzeugbau – German body for automotive standards – probably best known in textiles' industry for accelerated light stability test, DIN 75202.
FDY	fully drawn yarn.
FES	flame emission spectrophotometry.
FISITA	International Federation of Automotive Engineering Societies.
FMEA	Failure Mode and Effects Analysis – a systematic procedure to assess the potential failure of a component or process and its effects and to establish ways to prevent re-occurrence.
FR	flame-retardant properties.
FRP	fibre-reinforced plastic.
FTIR	Fourier transform infra red (analysis).
GC	gas chromatography, an analytical method.
GLC	gas liquid chromatography, an analytical method.
GRP	glass-reinforced plastic.
GRU	glass-reinforced urethane.
GRV	gross vehicle weight.
HDPE	high density polyethylene.
HMPE	high modulus polyethylene.
HOY	high-orientated yarn.
HT	high tenacity – a term applied to yarns of above

	average tensile strength, i.e. generally in excess of 7 g/dtex.
IFAI	Industrial Fabrics Association International.
IMMFC	International Man-Made Fibres Congress (Dornbirn, Austria).
IMO	International Maritime Association.
IMR	in mould reaction.
INDA	Industrial Nonwoven and Disposables Association, (USA).
IP	instrument panel.
IPC	integrated pollution control.
IPPC	integrated pollution prevention and control.
IR	infra red.
ISO	International Standards Organisation.
ISOPA	European Isocyanate Producers' Association (Polyurethane Industry) – an organisation within the European Chemical Industry Federation (CEFIC).
ITMA	International Textile Machinery Association (Exhibition every four years in Europe).
IWS	International Wool Secretariat.
JAR	Joint Aviation Regulations.
JASO	Japanese Automobile Standards Organization.
JIS	Japanese International Standard.
LCA	life cycle analysis – a method of assessing a product or process for impact on the environment which takes into consideration every factor, from the raw materials, production, distribution, use and disposal. Also referred to as 'cradle to grave' analysis.
LCP	liquid crystal polymer – used in instrument panel displays.
LDPE	low density polyethylene.
LEV	low emissions vehicle.
LOD	limiting oxygen index, FR test used mainly by researchers.
MF	melamine formaldehyde.
MFI	melt flow index-viscosity measurement for molten polymers and adhesives.
MIRA	Motor Industries Research Association (UK).
MPV	multi-purpose vehicle.
MPW	mixed plastics waste.
MS	mass spectrometry, an analytical technique.
MUTA	Made up Textiles Association.
NAMAS	National Measurement Accreditation Service – by the NPL (UK).

NBR	acrylonitrile butadiene rubber.
NBS	National Bureau of Standards (US).
NFPA	National Fire Protection Agency (USA).
NMR	nuclear magnetic resonance, an analytical technique.
NPL	National Physics Laboratory, (UK).
NR	natural rubber.
NSCA	National Society for Clean Air and Environmental Protection, (UK).
NVH	noise, vibration and harshness.
OEL	occupational exposure limit (of chemicals).
OEM	original equipment manufacturer, i.e. Ford, BMW etc.
OICA	International organization of motor vehicle manufacturers.
PA	polyamide, known also as nylon – designated with numbers which relate to the starting materials from which they are made, e.g. nylon 6, nylon 66, nylon 46 etc.
PAN	polyacrylonitrile, usually refers to acrylic fibre, e.g. Courtelle.
PBDE	polybrominated diphenyl ethers.
PBI	polybenzimidazole, a material with very high FR properties.
PBTP	polybutylene terephthalate, a polymer related to PET, with more stretch in yarn form and a lower melting point.
PCDD	see dioxins.
PE	polyethylene.
PET	polyethylene terephthalate, known commonly as polyester.
PO	polyolefin, a general chemical term used to describe plastics made from polyethylenes and polypropylenes.
POY	partially orientated yarns.
POY	pre-orientated yarn.
PP	polypropylene.
PRAVDA	Project Altfahrzeugverwertung Deutscher Automobilhersteller, (German automobile manufacturers used vehicle recycling project).
PSAB	pressure-sensitive adhesive-backed.
PSB	polystyrene-butadiene rubber.
PSV	public service vehicle.
PU	polyurethane, interior trim can be made from polyurethane polyester foam or from polyurethane polyether foam. In the trade they are referred to as

	'polyester foam' or 'polyether foam' and even as simply, 'ether' and 'ester'. Not to be confused with polyester.
PUR, (PU)	polyurethane.
PURRC	Polyurethane Recycle and Recovery Council (of the Society of the Plastics Industry – USA).
PVA(c)	polyvinyl acetate.
PVA(l)	polyvinyl alcohol.
PVC	polyvinylchloride.
PVDC	polyvinylidene chloride.
PVDF	polyvinylidene fluoride.
QS 9000	Quality system based on ISO 9000 specially designed for the auto industry.
Rad XL PP	radiation crosslinked polypropylene (foam).
RAPRA	Rubber and Plastics Industry Research Association (UK).
RIM	reaction injection moulding.
RV	recreational vehicle.
SAE	Society of Automotive Engineers, (USA).
SAMPE	Society of Advanced Materials and Process Engineers, (Composites).
SBR	styrene butadiene rubber.
SDC	Society of Dyers and Colourists (UK).
SEM	scanning electron microscopy.
SEPA	Scottish Environmental Protection Agency.
SERA	Socialist Environmental and Resources Association.
SME	small medium enterprise.
SMMT	Society of Motor Traders and Manufacturers.
SPC	Statistical Process Control.
S-RIM	structural reaction injection moulding.
SUV	sports utility vehicle.
Tack	the property of an adhesive to form a measurable bond, immediately it is brought into contact with a surface under low pressure. Sometimes referred to as 'grab' or 'green tack'.
Taguchi Methods	Statistical techniques for prototyping and optimizing product and process design.
TDI	toluene di-isocyanate.
TI	Textile Institute.
TLV	threshold limit value.
TPE	thermoplastic elastomer.
TPO	thermoplastic polyolefin.
TPU	thermoplastic polyurethane.

TQM	Total Quality Management.
TSS	total suspended solids (in effluent).
UF	urea-formaldehyde.
UL	Underwriter's Laboratory (e.g. for FR testing).
UV	ultra violet.
VDI	Verein Deutscher Ingenieure – Association of German Engineers.
VOC	volatile organic compound.
UNCED	United Nations Conference on the Environment.
WIRA	Wool Industries Research Association.
ZEV	zero emissions vehicle.

### **11.7 Abbreviations used in references at end of chapters**

ATI	America's Textiles International.
BPR	British Plastic and Rubber.
EPN	European Plastic News.
IMMFC	International Man-Made Fibres Congress.
JSDC	Journal of the Society of Dyers and Colourists.
JTN	Japanese Textile News, Monthly.
MPI	Modern Plastics International.
PRW	Plastics and Rubber Weekly.
TTi	Technical Textiles International.
TuT	Technical usage Textiles (France).

# Subject Index

(For test methods and standards, see Table 5.1 in Chapter 5 and Table 7.1 in Chapter 7. Only those not presented in these two tables are included in this Index.)

## Index terms

## Links

### A

AAMTCC	113	343			
ABC pillars	16	216	219	338	348
Abrasion resistance, ( <i>see also testing</i> )	9	44	51	126	160
	283	305	307	328	329
ACORD	272				
Acordis	122	244	284	324	329
Acoustic insulation, <i>see sound proofing and noise insulation</i>					
Acrylic fibre	10	12	13	244	293
	313				
resin	138	242	296		
Adhesion, factors influencing	124	139	147	186	293
	294				
mechanisms of	139				
Adhesives, ( <i>see also lamination</i> )	17	140	143	152	
hot melt, (powder, web, film)	17	140	145		
moisture curing	150				
solvent based	140				
water based	140				
ADtraz	306				
Aesthetic design	35				
Agile manufacturing	136				
Aerotek	330				

<u>Index terms</u>	<u>Links</u>				
Airbags	7	16	215	231	317
coating of	232				
causing fatalities	233				
legislation	231	233			
market size	231				
'smart'	233				
testing of fabric	229				
variants and related products	215	231	311		
Airbus Industries	288				
Air conditioning in cars	210	333			
Aircraft	311				
carpets	316				
composites	288	316			
escape chutes	317				
fireblockers	315				
flammability	312				
furnishing fabrics	311				
interior design	311				
life rafts and jackets	317				
volumes and growth	311				
seat belts	317				
weight savings	281	288	312	316	
Airjet spinning	47				
Air textured yarns	25				
Air texturizing	51				
Air porosity of fabrics	209				
Airships	319				
Algae 'blooms'	266				
Alkali dyeing	121				
Alcantara	204	209	274		
Alveo foam	215				
Amaretta	204				
Amicor	329				
AMPE	17	348			

<u>Index terms</u>	<u>Links</u>				
Antimony FR agents <i>see flame retardancy</i> , also bromine compounds					
Anti-static finishes	165	182	308	309	316
yarns <i>see Negastat (DuPont) and     Resistat (BASF)</i>					
Anti-soil <i>see cleanability</i>					
Antron P140 (DuPont)	308				
Applied design	32				
Aramid ( <i>see also Kevlar</i> )	245	284	285	305	
ASHRAE Comfort Standard	207				
ASTM E-99B water vapour permeability test	188	209			
Atlas light fastness tester	169				
Audi	235				
Automobile					
conferences	338				
history	4				
interiors	1	3	9	24	94
manufacturers	20				
publications	343				
'shredder residue' (ASR)	269				
statistics	1				
Autotech Conference	338				
 <b>B</b>					
BASF	134	285			
Battery separators	241	332			
market size	242				
Benz, Karl	4				
Back-coating <i>see coating</i>					
Bactekiller (Kanebo)	329				
Balloons (hot air)	319				
Bagging of fabrics	46				
BATNEEC	259	265			

<u>Index terms</u>	<u>Links</u>			
Basofil (BASF)	285			
'Bead' seat cover	207			
Beaufort Air Sea Equipment Ltd	318			
Belts (drive), advantages	247			
test methods	229			
Benninger warping machine	59	60		
Black-panel	172			
'Blind dyeing'	116	122	327	
BMW	231	235	240	331
Bonas Machine Company	64			
Bonnetliner (hoodliner)	16	242		
BS 5750	265			
BS 7421	188			
BREATH AIR (Toyobo)	201			
Bromine compounds (FR agents)	183	268	290	291
Brundtland Report	255			
BTTG	182	186	337	343
Bond strength <i>see</i> <i>adhesion</i>				
Bootliners (trunkliners)	16	220	242	
Brand recognition	3			
'Breathability' of car seats <i>see</i> <i>water vapour permeability</i>				
BRITE EURAM	209	348		
Bursting strength <i>see</i> <i>test methods</i>				
Buses and coaches	305			
use of composites	287			
seats	305			
seat belts	231			
vandal proof seat fabric	305	307		
Butyl rubber	247			
 <b>C</b>				
Cabin air filters	238			

<u>Index terms</u>	<u>Links</u>				
Filtrete (3M)	241				
method of action	239				
micronAir (Freudenberg)	240				
need for	238				
CAD <i>see design</i>					
Calenders <i>see lamination</i>					
Campaign models	34				
Carbon arc lamp	170				
Carbon dioxide	256 273 329				
<i>see also greenhouse effect and global warming</i>					
Carbon fibre	207 284 285 287 311				
Car clinics	34				
CARE	272 331				
Carding of fibres	47				
Carpets (automotive)	16 229 234				
coating	235				
composition	237				
noise control	236				
secondary (mats)	236				
CEN 2900	158				
Chenille yarns	53				
Chevrolet Indy Pace car	198				
Chromatex	22				
Chromaticity co-ordinates	115 167				
Chrysler (Daimler-Chrysler)	19 158 270				
Ciba	134 156 292				
CIE D65	185				
CIE 1976 lab co-ordinates	167				
CIELAB 1976 equation	167				
Clariant	120				
Cleanability	8 13 14 125 160				
	165 192 274 281 305				
	306 308 315 316 329				

<u>Index terms</u>	<u>Links</u>				
CMC (2:1) equation	167				
Coaches <i>see buses and coaches</i>					
Coating	111	137	157	292	317
	322				
calender	301				
direct	125	295			
fabrics used	293				
foam	124				
polymers used	294	296			
rotary screen	301				
transfer	299				
Coating and Lamination (annual) International Conference	339				
Colour measurement	114	167			
Colour spinning	25				
Colour CMYK	133	134			
Computer aided design	28	29	42		
Compounding (mixing)	18	138	247	294	
Core and effect yarns	51				
Collins and Aikman	20	237	311	312	
Colour Index	113				
Colour measurement	114	167			
Colour solid	114				
Comfort	8	188	205	207	210
	226	281	303	306	308
<i>(see also seat comfort)</i>					
Complan (PVC)	303				
Composites	282	322			
advantages	286				
biodegradable	274	331			
introduction	282				
fabrication	288				
growth	282				
materials used	285				

<u>Index terms</u>	<u>Links</u>				
Composites ( <i>continued</i> )					
organizations	345				
<i>see also weight reduction</i>					
Conferences, automotive	338				
materials and machinery	339				
other relevant	339				
textiles	337				
COSHH Regulations	267				
Cosmopolitan Textile Company	213				
Cost reduction and control	6	19	206	216	221
	326	332			
Cotton	245	248	293		
Count systems of yarns	47	54			
Courses of knitted fabrics	77				
Courtaulds Automotive Products	25				
Courtaulds Research	94	122			
Coverstock (face material)	16				
Cramming of woven structures	67				
Crease resist process	45				
Crea Tech Process	274	331			
Creative design issue	35				
Crimp interchange	75				
Crimp of yarns	75				
CRS (child restraint systems)	230	233			
Crocking <i>see test methods</i>					
Cultural preferences	33	186			
Customization	327	333			
Cut resistant fibre (CRF-Hoechst)	307				

**D**

Daimler-Benz V Class Minivan	206
Daimler Gottlieb	4
Dashboard, materials	16

<u>Index terms</u>	<u>Links</u>		
Decitex	54		
Delta E	167		
Delphi	199		
Denier	54		
Design (interior)	24	331	
development process	32		
dumbing down of	36	40	
computer assisted (CAD)	26	29	42
education	31		
led companies	28		
of fabrics	28		
understanding requirements	36		
Development opportunities	328		
of velvet fabrics	74		
DI-LOUR	104		
Dobby weaving	62		
Dolan fibre	244		
Dobby looms	64		
Door casing (panel)	16	215	
materials	16		
moulding	216	218	
textile insert moulding	215		
Dornbirn IMMF Conference	337		
Dornier	64		
Double needle bar Raschel	80		
Double plush pile fabrics	69		
Douglas Aircraft Company	311		
Drafting of woven designs	62		
Drag factors	24		
Draw ratio	46		
Draw warping	46		
Drawing of fibres	45		
Draw texturizing	46		

<u>Index terms</u>	<u>Links</u>				
Du Pont	124	125	134	200	285
	286	308	313		
Dubied	94				
Dust particles	238				
Dye compatibility	114	120			
trichromatic mixture	114				
types	25	112			
Dyeing	112	156			
acrylic fibre	122				
alkali	121				
'blind'	116	122	327		
machinery	117				
nylon	121				
yarn package	116				
polyester	120				
recipe prediction	115				
yarn	116				
Dymetrol	205				
Dyneema (DSM-UHM fibre)	310				
 <b>E</b>					
Ecofil Fibre Clusters (DuPont)	200	202	206		
Eco-labelling, Blue Angel	269				
Oeko-Tex	269				
Toxproof	269				
White Swan	269				
EDANA	97	106	109	344	339
Electric vehicle	199	242	332		
ELV 'end of life vehicle'	7	21	254	269	272
	278	330			
EMAS	265	275	280		
EMS-Chemie AG	142				
En Cad	132				

<u>Index terms</u>	<u>Links</u>				
Engineering led company	28				
Enichem	204	205			
Epson	132				
ENDS Report	342				
Environmental agencies	260	266	342		
Environment, effect of car emissions on	257	263	329	334	
effect of car disposal <i>see ELV</i>					
future	329	279			
journals	342				
legislation	254	257	262		
pollution, air	140	144	261		
pollution, landfill	254	262	264	330	
pollution, water effluent	121	122	264	265	
protection acts	259	267			
Environmental ageing testing	185				
Ergonomics of car seats	211	224			
Examination (of fabric)	189	327			
Exhaust gases from cars	263	280			
Expofil	339				
EU Directives and legislation	238	254	257	261	268
	270	305	330		
 <b>F</b>					
 Fabric coating <i>see coating</i>					
Fabric designer	28				
Fabric technology choices	37				
Fade-Ometer	170				
Fadex F UV absorber (Clariant)	120				
FAKKRA	162	173			
False twist texturizing	49				
Feedstock yarns	51				
Federal motor vehicle standards	183	215	233		
Felts	104				

<u>Index terms</u>	<u>Links</u>				
FIBC	304				
Fibreglass	212	214	242	243	323
Fibres	22	44	348		
used in transportation	11	283			
Filament, continuous yarn	25				
intermingling	49				
knit–de-knit crimping	49				
Finishing of fabric	111	123	156		
warp knit	84				
weft knit	92				
woven	69				
woven pile	73	138			
Fireblockers	292	315			
Flame lamination <i>see lamination</i>					
Flame retardancy (FR)	183	289	305	307	308
	311	312	322		
disadvantages of FR finishes	291				
intumescent coatings	290				
fibres	292				
limiting oxygen index (LOI) of fabrics	283	315			
mechanisms	290				
testing of	183	315			
testing, (heat release)	313				
testing, (smoke opacity)	313				
toxicity of combustion gases	313	314			
<i>see also bromine compounds</i>					
Flatbed weft knits	38	94			
Flat bed lamination <i>see lamination</i>					
Float woven structures	61				
Float yarns	53				
Flock	53	205	221	236	343
Fluoropolymers	14	297			
FMEA	19				
Foam in place moulding	196				

<u>Index terms</u>	<u>Links</u>				
Foam processing	124				
Fogging	19	160			
Ford	19	158	160	261	270
	331				
Henry	5				
Ikon car	326				
Model T car	5				
Freudenberg	239				
Frosting	177				
Full rip fabrics	35	85			
<b>G</b>					
Gauge of machines, warp knit	76				
weft knit	77	83			
Gear crimping of yarns	49				
Gemstone range (Milliken)	206				
General Motors	4	19	94	158	198
	199	273			
Georgia Textile Machinery Company	106				
GEO Prism Car	199				
Glass filtering effect	10				
Glass reinforced plastics	285				
Globalisation	6				
Global car	5				
Global warming	255	329			
Goretex (WL Gore and Associates)	188	209	210		
Gossamer Albatross	287				
Greenhouse effect	9	255			
Greenhouse gases	256				
Grey scales	185				
Guide bars, weft knit	78				

Index termsLinks

<b>H</b>			
Haake Fog Testing apparatus	181		
Harmonization of testing	161	173	
Harness of jacquard looms	63		
Hart Fog Testing apparatus	181		
Headliners	16	212	
HCTM process	214		
Tramivex Process	214		
structure	213		
Heat history of synthetic fibres	45		
Heat setting (stabilization) of fabric	110	123	293
Heraeus Light Fastness tester	171		
Hewlett-Packard	132		
HCTM Process	214		
HGV vehicles	245	302	305
manufacturers	20		
Hohenstein Institute	188	269	344
Hot melt <i>see adhesives, also lamination</i>			
Hood (car roof)	243		
Hook and loop fasteners	197		
Hope Webbing	198		
Horse hair (rubberized)	201	209	
Hoses	247	252	
testing	229		
Hybrid car	330	332	
Hydroentanglement <i>see non-wovens</i>			
Hypalon (DuPont)	297		
<b>I</b>			
Ikon car <i>see Ford</i>			
Index Conference	339		
Inidex	284	315	

<u>Index terms</u>	<u>Links</u>		
Ink jet printing	38	39	
Internet purchasing	332		
Interplas	339		
Innotech	132		
Innovation	326	329	
Inter-Auto Conference	338		
Interior fibre friction	47		
Intermingling of filaments	49		
International Maritime Association	309	322	
Intumescent FR coatings	290		
IPPC	261		
Ishihara	114		
ISO 14001	255	265	329
ISO 2631	207		
ISO 9000	19		
ISO 9092; 1988	96		
Isoplan-Trevira	303		
ITMA Exhibition	339		
 <b>J</b>			
Jacquard, Joseph Marie	64		
looms	58	62	
patterning	37	332	
weft knit	87		
Jefftex	30		
JIT	6	19	161
Journals	339		
automotive	343		
composites	342		
dyeing and finishing	341		
environment	342		
plastics, rubber and chemicals	341		
textile	340		

<u>Index terms</u>	<u>Links</u>				
<b>K</b>					
Karl-Meyer	77	80	199		
Kaptex	203				
Kapok	4				
Kawabata	186	192			
Kevlar (Du Pont)	246	248	286	310	313
Kiefel, Paul	218				
Knit de-knit crimping	49				
Kunit	103	199	202	209	271
Kunststoff Exhibition	339				
Kuraray	204				
Kyoto Environmental Conference	257	275	329		
<b>L</b>					
Lamination ( <i>see also adhesion and adhesives</i> )	139	157			
discussion of methods	153				
calender	145				
hot melt					
environmental issues	267				
flame	111	143	155	157	267
‘open’					
slot die extruder	151				
Landfill	254	262	264	330	
Lantor, Breatherfelt	288				
Firet Coremat	288				
‘Lean production’	6				
Leather, natural	203	209			
man-made and suede	204				
Lear Corporation	7	199	221		
Le Shuttle	308				
Life cycle analysis (‘cradle to grave’)	269	287			
Life jackets	296	317			

<u>Index terms</u>	<u>Links</u>			
Life rafts	296	318		
Lindau-Dornier	66			
Light fastness	10	162	168	305
<i>(see also UV degradation)</i>				
Loop raised warp knit fabric	84			
Lorica	204	209		
Lubricants	122	179	266	
Lycra	75			
Lyon, France home of Jacquard	64			

**M**

Machtex lamination machine	153			
Mace snag tester	179			
Macintosh, Charles	137			
Market information	347			
Marine uses of textiles	296	308		
coated products	310			
growth	309			
importance of FR	308			
Martindale abrasion test	51	173	307	
Mathis Oven	299			
Mayer and Cle MCPE jacquard	87			
MCPE weft knit jacquard machine	87			
Meadows and co-workers (environment)	255			
Meltblown <i>see non-wovens</i>				
Mercedes	235	240	273	
Metamerism	115	159		
Meyer Calender	148			
Michel Van De Wiele	71			
Microfibres	204	205		
Middle East Oil Crisis	9	24		
'Minking'	185			
Mirror image of double plush jacquards	70			

<u>Index terms</u>	<u>Links</u>				
Mobile homes	306				
Modacrylic	283	313	314		
Modular construction of automobiles	6	212	221	236	332
Moisture regain of fibres	11				
Montreal Protocol	257				
Moulding of plastics	17	216	218	219	235
	288				
MPV (multipurpose vehicle)	6	206	328		
Multiknit	199	202			
Munsell Book of Colour	114				
<b>N</b>					
Natural fibres, renewed interest	4	202	214	217	220
	274				
use in composites	274				
NHTSA (US highway safety)	233				
Needlepunching	102	104			
Negastat (DuPont)	182				
Neoprene rubber (DuPont)	18	232	247	297	304
New Generation Vehicle	332				
Nissan	331				
Nitrile rubber	247	296			
Noise, control	105				
insulation	220	235	236		
road noise	238	246	248		
Nomex (Du Pont)	285	286	308		
Non-woven fabrics	95	108			
alternative to polyurethane foam	105	200	213	214	218
	234	271	275		
definition	95				
hydroentanglement	103				
moulding	105	215			
speed of production	96				

<u>Index terms</u>	<u>Links</u>				
Non-woven fabrics ( <i>continued</i> )					
production methods	96				
use in the car	97	105			
web formation	96				
Nordson	152				
North Sea Conferences (environment)	258	259	265	283	293
Nylon	6	8	10	11	66
	258	259	265	283	293
Nylon	46	232			
 <b>O</b>					
Obem dyeing machine	118				
Odours in cars	188	328			
Office furniture	95				
Oligomer	120				
Oko (or Oeko) Tex <i>see eco-labelling</i>					
Open end spinning	47				
Outsourcing	6				
Ozone layer	258	263			
 <b>P</b>					
Panox (Lantor UCF)	284	314	315		
Parcel shelf (of cars)	16	218			
PBI (polybenzimidazole) fibre	284	315			
PBT (polybutylterephthalate)	53				
Particulate matter	238	263			
Particulate matter (PM)	239	256	262	263	
Peel bond ( <i>see also test methods and adhesion</i> )					
Pick-up truck	160	328			
Pilling	177				
Pirelli	205				

<u>Index terms</u>	<u>Links</u>				
Platforms (for vehicles)	5	333			
Plastics in cars	15	22	226	330	323
<i>(see also recycling)</i>					
advantages	15				
organizations	345				
types	16				
weight reductions <i>see weight reduction</i>					
Plush weft knit sinkers	87				
Point paper	60				
Pollutants <i>see environment</i>					
'Polluter pays' principle	266				
Polyamide <i>see nylon</i>					
Polybutylterephthalate (PBT)	53				
Polyethylene Ultra High Modulus;					
Dyneema (DSM)	284	310			
Spectra (AlliedSignal)	284				
Polyester	10	16	25	44	113
	120	124	141	194	208
	228	231	234	241	242
	245	247	271	275	283
	293	311	313		
Polypropylene	12	13	16	105	141
	215	218	237	241	243
	274	283	304	331	
Polypropylene, dyeability	13				
Polypropylene foam	16	234			
Polyurethane, coatings	138	204	226	296	
films	209				
moisture cure adhesives	150				
Polyurethane foam	16	14	226	234	
<i>(see also flame lamination)</i>					
alternatives to	199				
breathability	209				
compressibility	200				

<u>Index terms</u>	<u>Links</u>				
Polyurethane foam ( <i>continued</i> )					
sound insulation	237	243			
Porelle (Porvair)	209	210			
Porosity of materials	209				
Powder adhesives <i>see adhesives and lamination</i>					
POY	45				
PRAVDA	272				
Prepregs	289				
Presser foot technology (knitting)	39	126			
Printing	39	111	126	156	323
Batik	127				
block or hand	126				
colour separation	128				
flatbed screen	128				
heat transfer	130				
lkat	127				
ink jet	131				
resist	126				
roller	127				
rotary screen	129				
silk screen	128				
Proban (Albright and Wilson)	292	285			
Process colour of ink jet	131				
Production rates of woven fabrics	68				
PVC	8	16	18	141	207
	212	215	243	268	293
	295	296	298	299	310
	303	314	317	323	
Pyrovatex (Ciba)	292	285			
<b>Q</b>					
QS 9000	7	19	158	192	

<u>Index terms</u>	<u>Links</u>				
Quality Assurance	158	192			
Queen Elizabeth II	309				
<b>R</b>					
Railway textiles	306				
carpets	308				
composites	308				
CRF (cut resistant fibre)	307				
seat covers	307				
volumes	306				
RAPRA	337	339	345		
Rapier weaving	64				
Ramie fibre	210				
Rascal Van	199				
Raschel knitting	13	80			
rationalization of auto industry	7	221	324	333	
Rayon	245	247			
Recycling	7	17	254	269	279
'closed loop'	271				
interior trim	195	230	269	279	
logistics of car	272				
polyester bottles	220				
polyurethane foam	271				
Recytex	272				
Reeve Brothers	300	317			
Reliant Calender	147				
Resistat (BASF)	309				
Rieter-Scragg	49	52			
'Ring dyed'	113				
Ring spinning	47				
Roaches International	118				
Road safety	7	207	233	324	
<i>(see also seat belts and airbags)</i>					

<u>Index terms</u>	<u>Links</u>				
Ropes	310	322	322		
Robinson, Frank	94				
Rover	235				
Rovings	47				
Rubberised 'horse hair'	201	209			
'Run flat' tyres	246				
Rubber	18	227	244	252	294
	296	323			
organizations	345				
<b>S</b>					
Saab	210	235			
Safety	3	8	211	217	227
	267	281	309	324	332
Sales (of vehicles)	2	302			
Sails	310				
Sarna-Xiro film	141	212			
SBR rubber	18	296			
Schildnecht Flexing Tester	298	300			
Schopper abrasion test	173				
Scrim fabric in laminate	14	111			
Scotchguard Finish (3M)	125				
ScotWeave CAD System	30				
Scouring of fabric	122				
Seat belts	16	206	228	317	
test methods	229				
Seat covers	16				
construction	14	44			
design	22				
early fabrics	8				
fabric	8				
materials	8				
performance standards	162				

<u>Index terms</u>	<u>Links</u>				
Seat covers ( <i>continued</i> )					
test methods	166				
Seat comfort	166	207			
body support	207				
breathability of materials	209				
measuring seat thermal comfort	208	224			
overall picture	210				
porosity of materials	209				
thermal comfort	188	207			
Seat structure, methods of construction	195				
alternative methods and materials	199				
Section warping	59				
Seiren	136	137			
Sewing threads	203	226			
Shafts on dobby looms	58	62			
Shima Seiki	94	95			
Ships <i>see marine</i>					
Shogging in warp knits	78				
Silicones	124	176	179	186	232
	297				
Single jersey	39				
Sisiara Seat System (Pirelli)	205				
Slot die extruder <i>see adhesives and lamination</i>					
Snagging	178				
Society of Dyers and Colourists	113	167	172	336	344
Soil resistance	328				
( <i>see also cleanability</i> )					
Sophis Systems in CAD	134				
Sound proofing	212	214	220	234	236
	238	243			
Spacer fabric	85	200	202		
Spectra fibre (AlliedSignal)	310	317			
Spectral absorption	168				

<u>Index terms</u>	<u>Links</u>			
Spectrophotometer	116	167		
Spinneret	45			
Spot colour	38	39		
Spun dyed	13	25		
Staple fibre	45			
Staple spinning	47			
SPC (statistical process control)	19	159	188	
'Stealth bus'	287			
Stentering	123			
<i>(see also finishing and heat setting)</i>				
Stitchbonded fabric	105			
Stoll	94			
Stork Brabant	133			
Stuffer box crimping	49			
Struto	98	105	199	202
Suede	204			
Sunvisor	16	220		
'Superfibres'	329			
Super pixel	38	39		
Suppliers, requirements from	19			
Sustainable development	255	269	330	335
SUV (sports utility vehicle)	6	231		
Sympatex (Akzo)	188	209	210	

## T

Taber method of abrasion testing	173			
Tarpaulins	294			
Titanium dioxide delustrant	172			
Techtextile Symposium	338			
Teflon (DuPont)	125			
Tencel (Acordis)	327			
Test methods (for automotive seat fabric)	159	192		
abrasion	44	173		

<u>Index terms</u>	<u>Links</u>				
Test methods ( <i>continued</i> )					
antistatic	182				
breathability ( <i>see also comfort</i> )	188				
cleanability	185				
colour	168				
crocking	168				
dimensional stability	145	184			
effect on fabric design	41				
flammability	183				
fogging	179				
frosting	177				
handle and drape	186				
harmonisation of	161	173			
laboratory conditions	166				
odour	188				
peel bond strength	179				
pilling	44	177			
snagging	188				
summary	162				
tear strength	186				
tensile strength	44	186			
UV degradation	168				
Test and Standards Organizations	346				
Textile Associations	343				
texturizing, air	25	51			
false twist	49				
Textile Institute	337	344			
Textile terms and definitions	348				
Thermoplasticity	17	45	154	215	216
Thermoset plastics	17				
Thinsulate acoustic insulation (3M)	220	221			
Thermalite acoustic insulation (DuPont)	220				
Tier suppliers (1, 2, '0.5') to car manufacturers	6	19	20	21	32
	221	333			

<u>Index terms</u>	<u>Links</u>				
Three-D (3D), fully fashioned, knitting of seat					
covers	94	196	198	327	333
'Three-litre' car	275				
3M Company	125	209	221	241	
Tramivex Process	214				
Travel, increasing	281	335			
Trevira	309				
Tricot warp knit	77				
Tristimulus colorimeter	116	167			
Toray	204				
Toyota	5	23			
Turl Dish test	188				
Tufting of carpets	101	235			
Tunnel Tie	198				
Twaron (Acordis)	305				
Twill weave	61				
Tyres	244				
cords	229				
cross-ply	244				
history of	244				
disposal of	246	262			
radial	244				
'run flat'	246				
structure of	241				
<b>U</b>					
UHM polyethylene	310	384			
Ultrasonic welding	154				
Ultra Tensile Steel (Goodyear)	246				
Underwriters Laboratory	310				
Universal strength tester	180				
Universities (with textile departments)	345				
Urethanes Conferences	339				

Index termsLinks

UV degradation	9	44	168	219	228
	243	293	296	304	310
	333				

**V**

Velvet wovens	70				
'V' weave	70	73			
'W' weave	70				
design and development	72	74			
finishing	73				
Jacquard constructions	71				
pile incorporation	70				
reflect warp principle	70				
tuft adhesion	70	71			
Vibration	195	211	222	235	238
	332				
Virgin Airlines	312				
ViscoteksR Seiren printing system	137				
Visil fibre	315				
Viton (Du Pont)	297				
VOCs	261	267			
<i>(see also environment air pollution)</i>					
Volkswagen (VW)	240	273			
Volvo	231	272			

**W**

Warp knit,					
courses and wales	77				
fabric characteristics	85				
finishing	84				
full rip	85				
guide bars	77	78			

<u>Index terms</u>	<u>Links</u>			
Warp knit ( <i>continued</i> )				
loop raised	85			
machine gauges	77	83		
needle action	82			
Raschel	80			
shogging	78			
tricot	77			
yarns used	84			
Water Acts	258			
Water vapour permeability (breathability) of seat covers	188	209	210	
( <i>see also seat comfort, thermal comfort</i> )				
Weather-Ometer	170	171		
Weight reduction	281	286		
aircraft	281	288	312	316
automobiles	17	22	274	330
buses	287			
ships	310			
trains	287	308		
<i>see also composites</i>				
Weft knit	86	108		
circular	39			
cropping	91	92		
cropping waste	91			
cylinder	87	89		
design and development process	83	84	91	
fabric characteristics	94			
finishing	94			
flatbed	38	94		
floats	91	93		
gauge	89	90		
ground yarns	91			
needles	91			
pile crush	92			

<u>Index terms</u>	<u>Links</u>				
Weft knit ( <i>continued</i> )					
pile loops	87				
pile yarns	91				
production rates	93				
slitting	86	92			
spirality	86				
structures	86				
Welding	154	216			
high frequency (HF)	154				
radio frequency (RF)	154				
ultrasonic	154				
Welding Institute (The)	346				
Wellman	271				
Wheel arch liners	243				
Wolffe Walsrode (Bayer) film	210				
Wool	12	13	34	175	208
	283	307	313	314	345
Wool Blue Scales	172				
Woven fabrics	37	54	107		
characteristics	74				
constructions	68				
design and development	69				
finishing	69				
finishing process	69				
Jacquard cast out system	63				
Jacquard design repeats	63				
pile structures	69				
stretch	26	75			
stretch by pile interchange	75	76			
thermoplastic	45				
twill weave	61				
warp and weft	57				
weights	68				

Index termsLinks

## X

Xenon Arc Lamp	170
Xiro ( <i>see Sarna-Xiro</i> )	

## Y

Yarns	44	106
air textured	25	
chenile	53	
core and effect	51	
feedstock	51	
filament	25	
flock	53	
jet spun	47	
parallel textured	51	
ring spun	47	
spinning systems	47	
spun dyed	13	25
stretch PBT	53	
thickness	54	
types	46	
wrap spun	47	
Yarn Index	348	

## Z

Zero emissions car	242	330
Zero defects	159	189 327
Zimmer	133	
Zirpro wool	13	292 305 309 314
	315	